



# LOCKER CATALOG

 **Material Handling USA**

**800-326-4403**

<https://www.mh-usa.com/>

[Sales@MaterialHandling-USA.com](mailto:Sales@MaterialHandling-USA.com)

# About Us

Businesses and corporations worldwide have a common, universal need: Secure, efficient, and reliable storage. Penco is proud to offer a broad selection of solutions to meet that need. As one of America's largest and most trusted suppliers of storage and work-area products, our state-of-the-art manufacturing facilities and strategically located QuickShip distribution centers make us the best choice for storage essentials.

Penco's target markets range from educational, healthcare, and government facilities to offices, manufacturing companies, distribution warehouses, retail outlets, sports arenas, and more.

Our shelving and pallet rack products are attractive to warehouses and manufacturers. Our locker lines appeal to educational facilities, fitness centers, healthcare offices, military areas, emergency response units commercial arenas, and industrial locations.

All products manufactured by Penco Products are UL Environment GREENGUARD Gold Certified.



## Our History

In 1869, L. Lewis Sagendorph achieved his dream to open a company that would make the finest metal products in America. He called his fledgling business the Penn Metal Corporation of Pennsylvania, where he produced steel culvert pipe on Oregon Avenue in South Philadelphia.

Over the years, Penn Metal's product lines broadened to include lockers, shelving, and even aircraft landing mats. Before long, the company's reputation for quality fabrication grew nationwide. In the 1950's, the name was shortened to Penco Products and the plant and offices expanded to a modern facility in Oaks, Pennsylvania, near Valley Forge.

In 2001, Penco moved the manufacturing plant to a 475,000 square foot facility in Hamilton, North Carolina, allowing significant room for expansion. In 2013, Penco relocated the corporate headquarters to Greenville, North Carolina.

## Customer Service

Based at the home office in Greenville, NC, Penco's Customer Service team is knowledgeable and dedicated to excellence in every area of business. Our goal is to provide professional, timely, and accurate service to all customers in a fair, consistent, and accessible manner. Penco's distributor partners and customers are our number one priority.



pencoproducts.com | 800.562.1000

# Lockers

- Locker Overview..... 4
- Vanguard™ Lockers ..... 6
- QuickShip Vanguard™ Lockers..... 9
- QuickShip Locker Accessories..... 10
- Guardian™ Lockers ..... 14
- Invincible II™ Lockers..... 16
- Welded Gen2 Lockers..... 18
- Stadium Fully Framed Locker.....20
- Patriot Fully Framed Lockers™.....22
- Patriot Fully Framed Accessories..... 37-42
- Locker Accessories.....44
- Special Purpose Lockers.....50
- Shoulder Pads & Helmet Racks.....51
- Basket Racks & Baskets.....52
- ADA/Environmental.....78
- Colors.....79
- Full Feature Garment Lockers .....80



Guardian™ Lockers

# Specifications

- Vanguard™ Lockers .....53
- Guardian™ Lockers .....54
- Invincible II™ Lockers.....56
- Welded Gen2 Lockers.....58
- Locker Accessories.....60
- Defiant II™ Single Point Latch.....61
- Fully Framed Stadium Lockers™ .....62
- Patriot Fully Framed Lockers.....64

# QUICKSHIP Locker Program

4 STRATEGIC LOCATIONS



Penco Products leads the industry with its comprehensive QuickShip program. Penco's QuickShip Distribution Centers have been strategically located throughout North America to best serve customer needs with prompt delivery of products from the shortest distance possible. Penco's QuickShip program saves time, delivery cost and energy, thus reducing the impact on our environment.

Visit [pencoproducts.com/penco-programs/quickship](http://pencoproducts.com/penco-programs/quickship) for a listing of which products are available at each warehouse location shown.



## GREENGUARD

All products manufactured by Penco Products are GREENGUARD Gold Certified through UL Environment's GREENGUARD Certification Program. This certification signifies that Penco's products are in compliance with the stringent chemical emissions guidelines set by UL Environment.

Accredited courses are available to design professionals and fulfill credit requirements for AIA, GBCI, IDCEC. Contact a Penco Sales Manager for more information.

## Overview

Penco has been building lockers for over 150 years that last for decades and have become part of the fabric of American life. Look in any school and chances are you'll find Penco's lockers in the athletic department, field house, faculty break room and of course, lining the corridors.

School lockers may be Penco's foundation, but the spectrum of products doesn't end there. Penco has locker solutions for recreation centers, health clubs, hospitals, back office and industry break rooms, while at the same time delivering the widest range of solutions to serve first responders in the military, law enforcement and fire and rescue profession.

For locker specifications, see pages 53-59.

## Terms Used in This Catalog

**KD:** Knocked Down, or lockers that are shipped unassembled for assembly and installation at their destination.

**W:** Welded, or lockers that are shipped assembled for installation at their destination.

**GA:** Gauge of steel - indicates the thickness. The lower the number the thicker the steel.

**LH & RH:** Left Hand and Right Hand side of a locker, as seen standing in front of a locker.

**Tier:** A "level" of a locker defined by the number of doors in a vertical row. This can range from 1 to 9 tiers.

**Opening & Frame:** Opening is what is behind a door. A frame is the unit that holds the doors. There can be multiple doors per frame.

**Double Row:** "Back-to-back" lockers.

**Double Door Locker:** A locker with two full length doors that open in the center.

**W, D & H:** Width, Depth & Height dimensions (inches).

**CCBP:** Common Color Body Parts (Vanguard and Guardian only): Backs, tops, bottoms, sides, & shelves all come in 073 Champagne as standard. Full color available upon special order at an additional cost.



**NOTE:** Welded Gen2, Stadium and Patriot lockers are not shown above.

### Ventilation Options

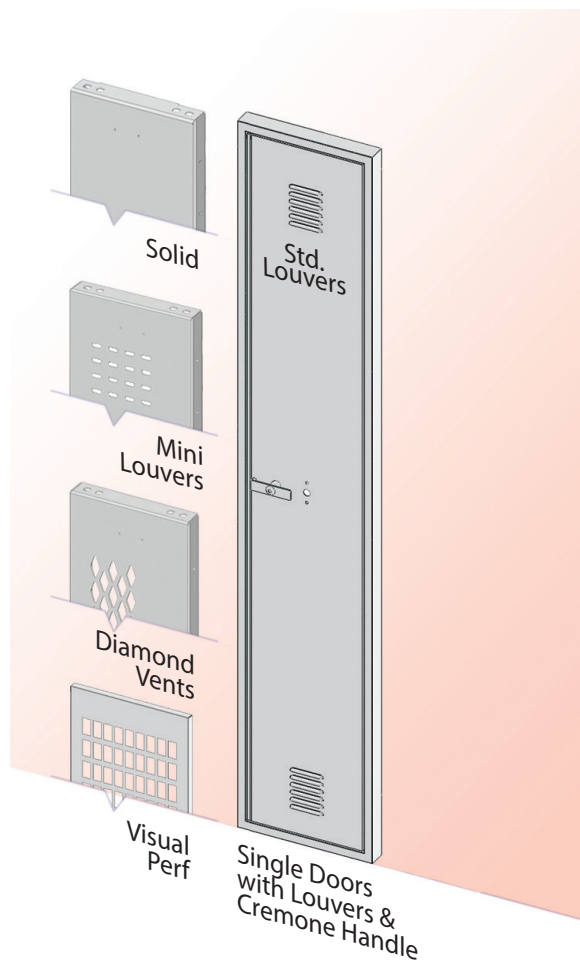

### Cremone Multi-Point Handle

Available on Guardian Plus, Invincible II, and Welded Gen2 ONLY



An unbreakable steel handle securely bolted to a 3-point latching system.

A 3/8" diameter latching rod engages at the top and bottom of the door frame. A 1/8" thick center latch locks the center of the door to the frame. The Cremone Handle is available on a variety of KD and welded heavy duty locker doors.

3 views below: top, middle, and bottom of inside of door with Cremone Handle.



### Handles & Latching



**Die-Cast Handle.** This patented die-cast handle opens multi-point latch lockers with one simple motion. Standard on 1, 2 & 3 tier, 2-Person and Duplex Vanguard lockers.



**Automatic Multi-Point Latching.** Allows the door to be closed without locking. Standard on all multi-point doors except box lockers, Single Point Latch doors and Cremone Handle lockers.

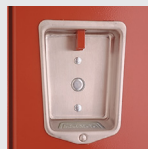

**Classic III Stainless Steel Recessed Handle.** Seamless deep drawn design is attractive as well as strong. Utilizes the Automatic Multi-Point Latching feature.

Standard on all 1, 2 & 3 tier 2-Person and Duplex, Vanguard Recessed, Guardian & Guardian PLUS lockers. Also standard on Invincible II and Welded Gen2 1, 2 and 3 tier lockers. This is the preferred handle for ADA lockers.



**Defiant II Single Point Latch.** Stainless steel deep drawn pocket with no moving parts (single point latch). Used with a vertical or horizontal pan welded to door. Standard on 1, 2 and 3 tier Defiant II Locker models.



**Anti Pry Lug.** Defeats prying attempts by capturing the door flange and preventing separation from the door channel.

See Defiant II details on page 52.



### Friction Catch Door Pull.

All box lockers come standard with this friction catch door pull handle with padlock hasp.

# Vanguard™

## At a Glance

- Knocked down construction
- Standard louvers for ventilation
- Classic III handle standard on QuickShip multi-point latch models
- 24 ga. body in CCBP or full color at additional cost
- Many sizes available through QuickShip

## Ventilation Options

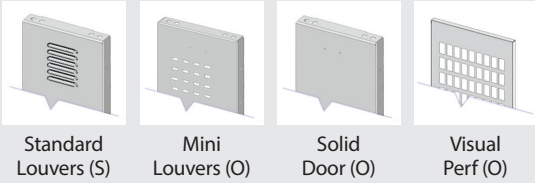

## Door Handle Options

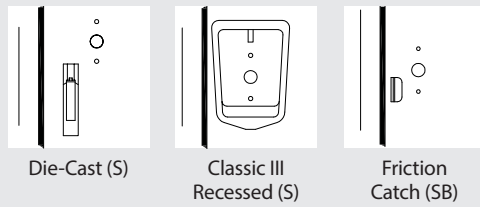

S = Standard O = Optional\* SB = Standard on Box Lockers  
\*additional charges may apply

For Vanguard specifications, see page 53.

Penco has been manufacturing lockers for decades that last for decades, and the Vanguard line is the embodiment of what it takes to withstand the daily use and abuse typically dealt to a locker.

The powder coat baked enamel finish is tough and available in all standard colors. For quieter operation, each frame features multiple noise reducing rubber bumpers.

The welded door frames have mortise and tenon construction and are spot welded for lifetime rigidity. Every door has a continuous door strike. All hinges are full loop, 5-knuckle design.

Note that different types of handles are available on many Vanguard lockers and that 3-tier Vanguard lockers have 3 handle choices.

Additional specialty Vanguard models are shown on page 8. Also, many popular Vanguard lockers are available in our QuickShip program with a limited color selection, as shown on pages 9 through 11.

**CCBP:** Common Color Body Parts (Vanguard and Guardian only): Backs, tops, bottoms, sides, & shelves all come in 073 Champagne as standard. Full color available upon special order at an additional cost. (This excludes Vanguard Duplex, Dual, 2, 7, 8, & 16-person, Wall Mount, Executive, Galvanneal, Double Door, & Box Over lockers).



Chart of  
24 Brilliant Colors  
See Page 76

## With Classic III Recessed Pocket Handles



## With Vanguard Cast Pull-out Handles



## With Box Locker Friction Catch Door Pull Handles





## Sizes and Dimensions

Vanguard 1, 2 & 3 Tier Lockers																	
		1 Tier						2 Tier						3 Tier			
Overall Height*		60"	72"	84"	60"	72"	84"	60"	72"	84"	60"	72"	84"	60"	72"	60"	72"
Opening Height*		60"	72"	42"	60"	72"	42"	30"	36"	42"	30"	36"	42"	20"	24"	20"	24"
Width	Depth	Die-Cast Handle			Classic III Handle			Die-Cast Handle			Classic III Handle			Die-Cast Handle		Classic III Handle	
9"	12"	6101V	6151V	-	6101R	6151R	-	6201V	6221V	-	6201R	6221R	-	-	-	6401R	6413R
	15"	6103V	6153V	-	6103R	6153R	-	6203V	6223V	-	6203R	6223R	-	-	-	6403R	6415R
	18"	6105V	6155V	-	6105R	6155R	-	6205V	6225V	-	6205R	6225R	-	-	-	6405R	6417R
12"	12"	6111V	6161V	6013V	6111R	6161R	6013R	6211V	6231V	6251V	6211R	6231R	6251R	6407V	6419V	6407R	6419R
	15"	6113V	6163V	6014V	6113R	6163R	6014R	6213V	6233V	6253V	6213R	6233R	6253R	6409V	6421V	6409R	6421R
	18"	6115V	6165V	6015V	6115R	6165R	6015R	6215V	6235V	6255V	6215R	6235R	6255R	6411V	6423V	6411R	6423R
	21"	6117V	6167V	-	6117R	6167R	-	6217V	6218V	-	6217R	6218R	-	6449V	-	6449R	6499R
	24"	6118V	6168V	-	6118R	6168R	-	6200V	6220V	-	6200R	6220R	-	-	-	-	-
15"	12"	6119V	6179V	6016V	6119R	6169R	6016R	6227V	6239V	6073V	6227R	6239R	6073R	-	6472V	-	6472R
	15"	6121V	6171V	6017V	6121R	6171R	6017R	6229V	6241V	6261V	6229R	6241R	6261R	-	6494V	-	6494R
	18"	6123V	6173V	6018V	6123R	6173R	6018R	6237V	6243V	6263V	6237R	6243R	6263R	-	6496V	-	6496R
	21"	6125V	6175V	-	6125R	6175R	-	6257V	6245V	-	6257R	6245R	-	-	-	-	-
	24"	6126V	6177V	-	6126R	6177R	-	6258V	6246V	-	-	6246R	-	-	-	-	-
18"	15"	6134V	6180V	-	6134R	6180R	-	-	6259V	-	-	6259R	-	-	-	-	-
	18"	6131V	6181V	-	6131R	6181R	-	-	6247V	-	-	6247R	-	-	-	-	-
	21"	6133V	6183V	-	6133R	6183R	-	-	6249V	-	-	6249R	-	-	-	-	-
	24"	6135V	6185V	-	6135R	6185R	-	-	6250V	-	-	6250R	-	-	-	-	-
24"	18"	6149V	6196V	-	6149R	6196R	-	-	-	-	-	-	-	-	-	-	-
	21"	6158V	6198V	-	6158R	6198R	-	-	-	-	-	-	-	-	-	-	-
	24"	6160V	6199V	-	6160R	6199R	-	-	6274V	-	-	6274R	-	-	-	-	-

Vanguard 2 Person and Duplex Lockers									
		2 Person				Duplex			
Overall Height*		60"	72"	60"	72"	60"	72"	60"	72"
Unit Width	Unit Depth	Die-Cast Handle		Classic III Handle		Die-Cast Handle		Classic III Handle	
15"	12"	6510V	6500V	6510R	6500R	-	-	-	-
	15"	6506V	6501V	6506R	6501R	6519V	6531V	6519R	6531R
	18"	6437V	6503V	6437R	6503R	6521V	6533V	6521R	6533R
	21"	-	6505V	-	6505R	-	6535V	-	6535R
18"	15"	-	6509V	-	6509R	-	-	-	-
	18"	-	6515V	-	6515R	-	-	-	-
	21"	-	6525V	-	6525R	-	-	-	-

Vanguard Box Lockers - 3, 4, 5 & 6 Tier								
		3 Tier		4 Tier		5 Tier		6 Tier
Overall Ht.*		60"	72"	60"	72"	60"	72"	72"
Opening Ht.*		20"	24"	15"	18"	12"	14-2/5"	12"
Unit Width	Unit Depth	Cat. No.	Cat. No.	Cat. No.	Cat. No.	Cat. No.	Cat. No.	Cat. No.
9"	12"	6301V	6313V	-	-	-	-	-
	15"	6303V	6315V	-	-	-	-	-
	18"	6305V	6317V	-	-	-	-	-
12"	12"	6307V	6319V	6325V	6331V	6343V	6353V	6365V
	15"	6309V	6321V	6327V	6337V	6345V	6355V	6367V
	18"	6311V	6323V	6329V	6339V	6347V	6357V	6369V
	21"	6349V	6399V	6393V	6395V	-	6435V	6371V
15"	12"	-	6372V	-	-	-	-	6363V
	15"	-	6394V	6333V	6431V	6351V	6359V	6373V
	18"	-	6396V	-	6433V	6397V	6361V	6375V
	21"	-	-	-	-	-	-	6377V
18"	18"	-	6335V	-	-	-	-	6379V
	21"	-	-	-	-	-	-	6378V

\* All dimensions are in inches. Overall Height is the overall height of the locker frame, NOT including legs. Opening Height is the nominal height of the individual door opening.

Opening Height for 2 Person Lockers: for 60" high models, bottom doors are nominal 42" high; for 72" high models, bottom doors are nominal 54" high. Book compartment doors are nominal 9" high each.

## Specialty Lockers



### Dual Lockers

A dual locker is a single tier locker with a vertical partition separating the area beneath the shelf into two compartments. It is ideally suited for situations where street clothes and work clothes are to be kept apart. It is generally used with lockers 15" or 18" wide and 18" or 21" deep. Guardian and Invincible II lockers can also be

supplied as dual lockers.

### 16 Person Locker

Accommodates 16 users in only 69" of floor space. Includes a 45" wide coat rod. Ideal for employee lockers. Accepts built-in locks or padlocks.

69"W x 18" D x 72"H. Cat. No. 6579V



### Box Over Lockers

Provides a compact independent lockable door above a 60" high standard Vanguard Door. If a shelf is required in the lower compartment, it must be ordered separately.

#### Box Over Lockers - 72" High

Unit Width	Unit Depth	Cat. No.
12"	12"	6439V
12"	15"	6441V
12"	18"	6443V
15"	15"	6436V
18"	18"	6445V
18"	21"	6447V



### The Executive

The Executive is a custom-outfitted 24" wide double door locker which offers such optional personal amenities as multiple storage shelves, lockable inner storage compartment, and combination comb & brush tray with towel bar. Shown here

with the available Classic III stainless steel recessed handle and optional front and end bases. Note that the depth of shelves and partitions are 3" less than the locker depth.

It is especially appropriate for golf clubs. Other accessories available include golf ball tray, acrylic mirror and name card holder. For ordering information contact your Penco representative.

### Wall Mounted Locker with Coat Rod



A practical storage unit where space is at a premium. Four private compartments with a hanging area for 16 coats. When wall mounted, the floor below is kept clear for easy cleaning (wall anchors are not included). Can also be set on counters or cabinets (without coat rod).

45"W x 18"D x 13-5/8" H.

Cat. No. 68242



### One High Box Locker

This 12" wide individual one high box locker provides storage for personal items and features standard box locker construction with friction catch door pull. Actual overall height is 13-5/8".

### 7 and 8 Person Lockers



These efficient lockers are ideal for multiple user situations such as school gymnasium locker rooms. The box compartments (18"W x 12"H) are for permanent storage of athletic gear. When a user is present, the large locker (18"W x 60"H) is used for street clothes.

#### 7 Person Locker

Unit Width	Unit Depth	Unit Height	Cat. No.
36"	18"	72"	6573V
36"	21"	72"	6575V

#### 8 Person Locker

Unit Width	Unit Depth	Unit Height	Cat. No.
54"	18"	72"	6577V

#### Optional Accessories



Comb & Brush Tray with Towel Bar



Card Holder



Inner storage compartment and golf ball tray

### Half Height Locker, 1 Tier



Available in 30-1/2", 36-1/2" and 48-1/2" heights; Available in 12", 15" and 18" depths; 12" wide. Only 48-1/2" high lockers include a shelf for storage of books and small articles.





For product listing by distribution center location, go to:  
[pencoproducts.com/penco-programs/quickship/](http://pencoproducts.com/penco-programs/quickship/)



## QuickShip Lockers

### Lockers in 5 working days

- KD lockers ship in 72 hours
- Many QuickShip accessories are available (see next pages)
- 1, 2 & 3 Tier models have Recessed Handles
- Assembly available by request
- 6" Legs standard (available with no legs by request)
- Number plates included
- 1, 2 and 3-Wide groupings

QuickShip Vanguard 1 Tier						
Grp.	Illustration	Width	Depth	Opn.Ht.*	028 Gray	073 Champagne
1-Wide		12"	12"	60"	68001R028	68001R073
		12"	15"	60"	68011R028	68011R073
		12"	18"	60"	68021R028	68021R073
		12"	12"	72"	68051R028	68051R073
		12"	15"	72"	68061R028	68061R073
		12"	18"	72"	68071R028	68071R073
		15"	18"	72"	68091R028	68091R073
		18"	18"	72"	68101R028	68101R073
2-Wide		12"	12"	60"	68002R028	68002R073
		12"	15"	60"	68012R028	68012R073
		12"	18"	60"	68022R028	68022R073
		12"	12"	72"	68052R028	68052R073
		12"	15"	72"	68062R028	68062R073
		12"	18"	72"	68072R028	68072R073
		15"	18"	72"	68092R028	68092R073
		18"	18"	72"	68102R028	68103R073
3-Wide		12"	12"	60"	68003R028	68003R073
		12"	15"	60"	68013R028	68013R073
		12"	18"	60"	68023R028	68023R073
		12"	12"	72"	68053R028	68053R073
		12"	15"	72"	68063R028	68063R073
		12"	18"	72"	68073R028	68073R073
		15"	18"	72"	68093R028	68093R073
		18"	18"	72"	68103R028	68103R073

QuickShip Vanguard 2 Tier						
Grp.	Illustration	Width	Depth	Opn.Ht.*	028 Gray	073 Champagne
1-Wide		12"	12"	30"	68111R028	68111R073
		12"	15"	30"	68031R028	68031R073
		12"	18"	30"	68041R028	68041R073
		12"	12"	36"	68121R028	68121R073
		12"	15"	36"	68131R028	68131R073
		12"	18"	36"	68141R028	68141R073
		15"	18"	36"	68261R028	68261R073
2-Wide		12"	12"	30"	68112R028	68112R073
		12"	15"	30"	68032R028	68032R073
		12"	18"	30"	68042R028	68042R073
		12"	12"	36"	68122R028	68122R073
		12"	15"	36"	68132R028	68132R073
		12"	18"	36"	68142R028	68142R073
		15"	18"	36"	68262R028	68262R073
3-Wide		12"	12"	30"	68113R028	68113R073
		12"	15"	30"	68033R028	68033R073
		12"	18"	30"	68043R028	68043R073
		12"	12"	36"	68123R028	68123R073
		12"	15"	36"	68133R028	68133R073
		12"	18"	36"	68143R028	68143R073
		15"	18"	36"	68263R028	68263R073

QuickShip Vanguard 3 Tier						
Grp.	Illustration	Width	Depth	Opn.Ht.*	028 Gray	073 Champagne
1-Wide		12"	12"	24"	68331R028	68331R073
		12"	15"	24"	68341R028	68341R073
		12"	18"	24"	68351R028	68351R073
2-Wide		12"	12"	24"	68332R028	68332R073
		12"	15"	24"	68342R028	68342R073
		12"	18"	24"	68352R028	68352R073
3-Wide		12"	12"	24"	68333R028	68333R073
		12"	15"	24"	68343R028	68343R073
		12"	18"	24"	68353R028	68353R073

QuickShip Vanguard 5 Tier						
Grp.	Illustration	Width	Depth	Opn.Ht.*	028 Gray	073 Champagne
1-Wide		12"	12"	12"	68161X028	68161X073
		12"	15"	12"	68171X028	68171X073
2-Wide		12"	12"	12"	68162X028	68162X073
		12"	15"	12"	68172X028	68172X073
3-Wide		12"	12"	12"	68163X028	68163X073
		12"	15"	12"	68173X028	68173X073

QuickShip Vanguard 6 Tier						
Grp.	Illustration	Width	Depth	Opn.Ht.*	028 Gray	073 Champagne
1-Wide		12"	12"	12"	68191X028	68191X073
		12"	15"	12"	68201X028	68201X073
		12"	18"	12"	68211X028	68211X073
2-Wide		12"	12"	12"	68192X028	68192X073
		12"	15"	12"	68202X028	68202X073
		12"	18"	12"	68212X028	68212X073
3-Wide		12"	12"	12"	68193X028	68193X073
		12"	15"	12"	68203X028	68203X073
		12"	18"	12"	68213X028	68213X073

QuickShip Vanguard Specialty Lockers						
16 Person						
Illustration	Width	Depth	Frame Ht.*	028 Gray	073 Champagne	
	69"	18"	72"	68231X028	68231X073	
Wall Mount						
	45"	18"	13-5/8"	68242X028	68242X073	

\* Height shown is the nominal opening height for 1 through 6 tier, and overall frame height for others, not including 6" legs which are standard on all except the Wall Mount Locker. Width is the nominal outside dimension for 1 frame.

\*\* Shaded area in illustrations indicates the unit of sale; i.e. Cat. No. 68003R028 is for one frame of a 12" x 12" x 60" 1 tier locker, but since it is packaged in a group of 3, it must be ordered in multiples of 3.

## QuickShip Locker Accessories

### QuickShip Slope Top Kits

1-Wide			
Width	Depth	Height	028 Gray
12"	12"	4"	60229H028
12"	15"	5"	60231H028
12"	18"	6"	60233H028
15"	18"	6"	60239H028
18"	18"	6"	60243H028
Width	Depth	Height	073 Champagne
12"	12"	4"	60229H073
12"	15"	5"	60231H073
12"	18"	6"	60233H073
15"	18"	6"	60239H073
18"	18"	6"	60243H073



3-Wide			
Width	Depth	Height	028 Gray
12"	12"	4"	60230H028
12"	15"	5"	60232H028
12"	18"	6"	60234H028
15"	18"	6"	60240H028
18"	18"	6"	60244H028
Width	Depth	Height	073 Champagne
12"	12"	4"	60230H073
12"	15"	5"	60232H073
12"	18"	6"	60234H073
15"	18"	6"	60240H073
18"	18"	6"	60244H073

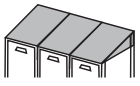

### QuickShip Slope Top Fillers

Slope Top Fillers			
Width	Depth	Height	028 Gray
15"	12"	-	661371-028
15"	15"	-	661372-028
15"	18"	-	661373-028
Width	Depth	Height	073 Champagne
15"	12"	-	661371-073
15"	15"	-	661372-073
15"	18"	-	661373-073

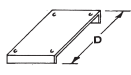

### Slope Top Corner Filler Kits - For use with continuous hood ONLY. Includes (1) slope top corner filler and (2) splices

Slope Top Corner Filler Kits			
Width	Depth	Height	028 Gray
12"	12"	-	66100-KIT-028
15"	15"	-	66101-KIT-028
18"	18"	-	66102-KIT-028
Width	Depth	Height	073 Champagne
12"	12"	-	66100-KIT-073
15"	15"	-	66101-KIT-073
18"	18"	-	66102-KIT-073

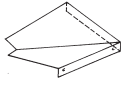

### QuickShip Hoods

Slope Hood (18 Ga.)			
Width	Depth	Height	028 Gray
72"	12"	5"	66144H028
72"	15"	6"	66147H028
72"	18"	7"	66150H028
Width	Depth	Height	073 Champagne
72"	12"	5"	66144H073
72"	15"	6"	66147H073
72"	18"	7"	66150H073



### Hood Splice

Width	Depth	Height	028 Gray
-	12"	-	66168-028
-	15"	-	66169-028
-	18"	-	66170-028
Width	Depth	Height	073 Champagne
-	12"	-	66168-073
-	15"	-	66169-073
-	18"	-	66170-073



### Left Hand Slope End

Width	Depth	Height	028 Gray
-	12"	-	66158H028
-	15"	-	66160H028
-	18"	-	66162H028
Width	Depth	Height	073 Champagne
-	12"	-	66158H073
-	15"	-	66160H073
-	18"	-	66162H073

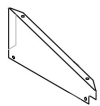

### Right Hand Slope End

Width	Depth	Height	028 Gray
-	12"	-	66159H028
-	15"	-	66161H028
-	18"	-	66163H028
Width	Depth	Height	073 Champagne
-	12"	-	66159H073
-	15"	-	66161H073
-	18"	-	66163H073

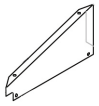

### Universal Hood Support

Width	Depth	Height	028 Gray
-	-	-	66070



## QuickShip Locker Accessories

### QuickShip Locker Bases, 6" High (for lockers with 6" Legs)

#### Front Bases

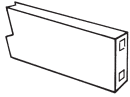

Width	Depth	Height	028 Gray
12"		6"	60217-028
15"		6"	60218-028
18"		6"	60219-028
Width	Depth	Height	073 Champagne
12"		6"	60217-073
15"		6"	60218-073
18"		6"	60219-073

#### End Bases

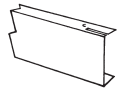

Width	Depth	Height	028 Gray
	12"	6"	60204-028
	15"	6"	60205-028
	18"	6"	60206-028
Width	Depth	Height	073 Champagne
	12"	6"	60204-073
	15"	6"	60205-073
	18"	6"	60206-073

### QuickShip Flat Top Fillers

#### Flat Top Fillers (Overlaps Standard Tops)

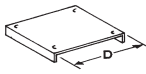

Width	Depth	Height	028 Gray
15"	12"	-	661321C028
15"	15"	-	661322C028
15"	18"	-	661323C028
Width	Depth	Height	073 Champagne
15"	12"	-	661321C073
15"	15"	-	661322C073
15"	18"	-	661323C073

#### Flat Top Corner Fillers

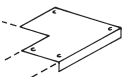

Width	Depth	Height	028 Gray
12"	12"	-	66138-028
15"	15"	-	66139-028
18"	18"	-	66140-028
Width	Depth	Height	073 Champagne
12"	12"	-	66138-073
15"	15"	-	66139-073
18"	18"	-	66140-073

### Flat Top Exposed Ends/Divisions (16 Ga.)

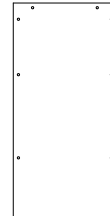

Width	Depth	Height	028 Gray
-	12"	60"	601660-028
-	15"	60"	601670-028
-	18"	60"	601680-028
-	12"	72"	601760-028
-	15"	72"	601790-028
-	18"	72"	601800-028
Width	Depth	Height	073 Champagne
-	12"	60"	601660-073
-	15"	60"	601670-073
-	18"	60"	601680-073
-	12"	72"	601760-073
-	15"	72"	601790-073
-	18"	72"	601800-073

### Hardware Kit - Locker Groupings

Description	Cat.No.
Hardware kit to join locker grouping together - 100 - 1/2" bolts and 100 - nuts	8633/72-Hkit



## QuickShip Locker Accessories

### QuickShip Fillers

#### Vertical Angles

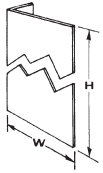

Width	Depth	Height	028 Gray
12"	-	60"	66113-028
12"	-	66"	661221-028
12"	-	72"	661141-028
12"	-	78"	66116-028
Width	Depth	Height	073 Champagne
12"	-	60"	66113-073
12"	-	66"	661221-073
12"	-	72"	661141-073
12"	-	78"	66116-073

#### Wall Angles (slip joint)

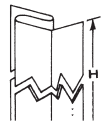

Width	Depth	Height	028 Gray
-	-	60"	66118-028
-	-	66"	66120-028
-	-	72"	66119-028
-	-	78"	66121-028
Width	Depth	Height	073 Champagne
-	-	60"	66118-073
-	-	66"	66120-073
-	-	72"	66119-073
-	-	78"	66121-073

#### Vertical Angle Kits - Includes (1) filler and (1) wall angle

Width	Depth	Height	028 Gray
12"	-	60"	66113-KIT-028
12"	-	66"	661221-KIT-028
12"	-	72"	661141-KIT-028
12"	-	78"	66116-KIT-028
Width	Depth	Height	073 Champagne
12"	-	60"	66113-KIT-073
12"	-	66"	661221-KIT-073
12"	-	72"	661141-KIT-073
12"	-	78"	66116-KIT-073

### Touch Up Spray Paint - 12 oz.

Must be ordered with lockers, shelving, or RivetRite products.	028 Gray	073 Champagne
	97028Z	97073Z

### QuickShip Zee Bases For Lockers without Legs

See illustration on page 13	Front Zee Base (14 Ga.)			
	Width	Depth	Height	028 Gray
	72"	-	4"	66700H028
	Width	Depth	Height	073 Champagne
	72"	-	4"	66700H073
	Zee Base Kits - Single Row - Includes (1) front zee base, (2) rear legs, and 1 splice/end			
	-	12"	4"	6ZBS412KIT
	-	15"	4"	6ZBS415KIT
	-	18"	4"	6ZBS418KIT
	-	12"	6"	6ZBS612KIT
-	15"	6"	6ZBS615KIT	
-	18"	6"	6ZBS618KIT	

### QuickShip Zee Bases For Lockers without Legs

See illustration on page 13	Splice/End Base			
	Width	Depth	Height	028 Gray
	-	12"	4"	66701H028
	-	15"	4"	66702H028
	-	18"	4"	66703H028
	Width	Depth	Height	073 Champagne
	-	12"	4"	66701H073
	-	15"	4"	66702H073
	-	18"	4"	66703H073

## QuickShip Locker Accessories

### QuickShip Zee Bases For Lockers without Legs

See illustration on right	Zee Inside Corner Splice			
	Width	Depth	Height	028 Gray
	-	12"	4"	66709H028
	073 Champagne			
	-	12"	4"	66709H073
	Rear Leg (for use with 4" high Zee Base)			
	Width	Depth	Height	028 Gray
	-	-	13"	60092-028
	073 Champagne			
	-	-	13"	60092-073

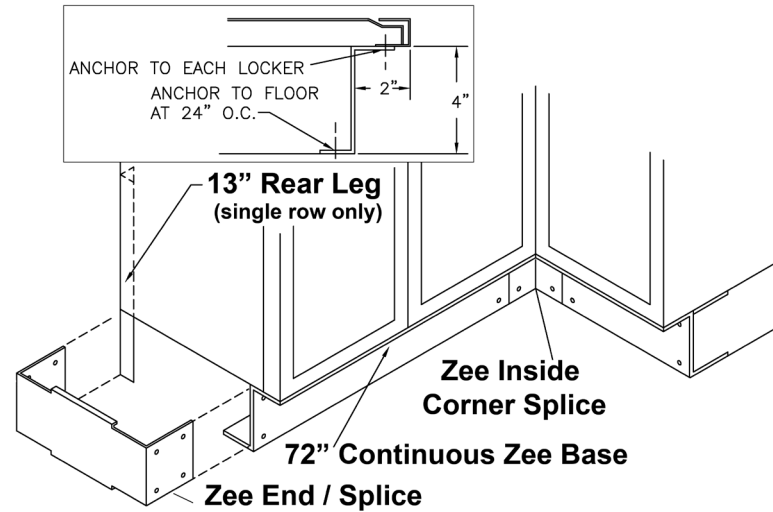

### QuickShip Locker Room Benches & Accessories

Width	Depth	Height	Cat. No.	Description
Hardwood Bench Tops				
36"	9-1/2"	1-1/4"	9611	Finished with clear lacquer. Use 2 pedestals per bench through 96".
48"	9-1/2"	1-1/4"	9600	
72"	9-1/2"	1-1/4"	9602	
96"	9-1/2"	1-1/4"	9604	
Steel Tube Heavy Duty Pedestals				
028 Gray	16-1/4"	60822H028	Includes hardware to mount to bench. Pedestal must be anchored to floor for safety - see concrete floor anchor.	
073 Champagne	16-1/4"	60822H073		
Stainless Steel Pedestal				
-	16-1/4"	60827H	Includes hardware to fasten to bench. See non-skid kit below.	
Non-Skid Pedestal Kit for Stainless Pedestal				
-	-	68420	Set of 4 rubber feet and hardware for Stainless Steel Pedestals. Order 1 set per pedestal.	
Concrete Floor Anchor 1/4" Diameter				
-	2"	9680		

### ADA Benches/Bracket/Shelves/Logo

Width	Depth	Height	Cat. No.	Description
Hardwood Benches for ADA Applications				
42"	18"	1-1/4"	9625	These benches are used with the Bench Bracket (below).
42"	24"	1-1/4"	9624	
48"	18"	1-1/4"	9628	
48"	24"	1-1/4"	9623	
Bench Bracket for ADA Bench				
Width	Depth	Height	028 Gray	073 Champagne
-	20"	20"	6ACXHP61H028	6ACXHP61H073
To provide back support with 18" bench and 24" seat.				
ADA Logo Label				
-	-	-	8690	
Locker Shelves for ADA Applications				
Width	Depth	Height	028 Gray	073 Champagne
12"	12"	-	60400-028	60400-073
12"	15"	-	60402-028	60402-073
12"	18"	-	60404-028	60404-073
15"	18"	-	60408-028	60408-073
18"	18"	-	60412-028	60412-073

Extra shelves must be installed in the field - may require drilling.

### QuickShip Locks

Description	Cat.No.
Dead Bolt, Flat Key Lock	9617
Master Key for Dead Bolt Flat Key Lock	96171

## At a Glance

- Knocked down construction
- Standard solid 16 ga. door and Classic III handle
- 14 ga. door available
- Optional Defiant II single point latching

### Ventilation Options

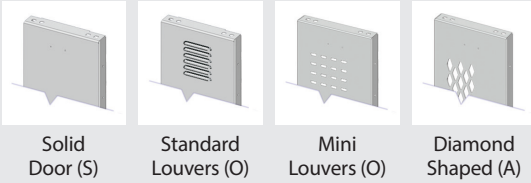

Solid Door (S)

Standard Louvers (O)

Mini Louvers (O)

Diamond Shaped (A)

### Door Options

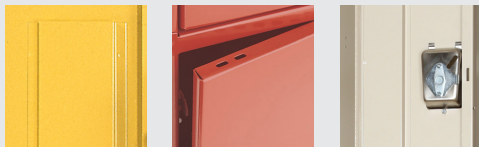

Medallion (O)

Guardian PLUS (A)

Guardian Defiant II (A)

### Door Handle Options

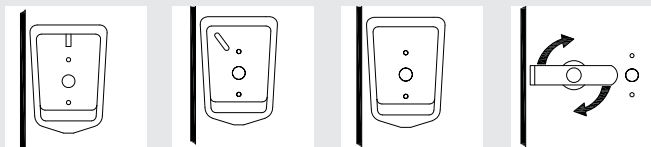

Classic III Recessed (S)

Defiant II Recessed (A)

Defiant II Rotary Recessed (A)

Cremona Turn Handle A - On most Guardian "Plus" models

S = Standard O = Optional\* A = Available with 14 gauge door only\*  
\*additional charges may apply

For Guardian specifications, see page 54.  
For Defiant Doors, see page 61.

**CCBP:** Common Color Body Parts (Vanguard and Guardian only): Backs, tops, bottoms, sides, & shelves all come in 073 Champagne as standard. Full color available upon special order at an additional cost. (This excludes Guardian Duplex, 2-person, Galvanneal lockers).



Standard Guardian lockers build upon the design features of the Vanguard series with several enhancements and options that give it a distinctive look.

Our one piece deep drawn Classic III stainless steel recessed pocket is part of every Guardian. It eliminates protrusions from the locker front and accepts a padlock or a built-in lock.

The 16 gauge door front has a solid exterior, aiding quiet operation. Ventilation is achieved by slots in the top and bottom flanges of the door.

**Medallion Option:** This upgrade has a sound damping panel welded to the door reducing noise levels when doors are slammed.

**Guardian PLUS:** This upgrade increases the thickness of the door to 14 gauge. The Guardian PLUS locker is ideally suited for corridors and situations where the locker is likely to encounter harsher than normal usage.

**Guardian Defiant II:** This combines a 14 gauge door with a single point latch stainless steel pocket and a reinforcing pan that stiffens the door. See page 53 for more information.



1 Tier

2 Tier

3 Tier

2 Person

Duplex



## Sizes and Dimensions

Guardian 1 Tier Lockers									
		Standard Door 16 ga.*		Medallion Door 16 ga.*		Guardian PLUS 14 ga.		Defiant II Latch- 14 ga.	
Opening Height		60"	72"	60"	72"	60"	72"	60"	72"
Width	Depth	Cat. No.	Cat. No.	Cat. No.	Cat. No.	Cat. No.	Cat. No.	Cat. No.	Cat. No.
9"	12"	6101G	6151G	6101M	6151M	6C101	6C151	-	-
	15"	6103G	6153G	6103M	6153M	6C103	6C153	-	-
	18"	6105G	6155G	6105M	6155M	6C105	6C155	-	-
12"	12"	6111G	6161G	6111M	6161M	6C111	6C161	6E111	6E161
	15"	6113G	6163G	6113M	6163M	6C113	6C163	6E113	6E163
	18"	6115G	6165G	6115M	6165M	6C115	6C165	6E115	6E165
	21"	6117G	6167G	6117M	6167M	6C117	6C167	6E117	6E167
	24"	6144G	6168G	-	6168M	6C144	6C168	-	-
15"	12"	6119G	6169G	6119M	6169M	6C119	6C169	6E119	6E169
	15"	6121G	6171G	6121M	6171M	6C121	6C171	6E121	6E171
	18"	6123G	6173G	6123M	6173M	6C123	6C173	6E123	6E173
	21"	6125G	6175G	6125M	6175M	6C125	6C175	6E125	6E175
18"	18"	6131G	6181G	-	6181M	6C131	6C181	6E131	6E181
	21"	6133G	6183G	-	6183M	6C133	6C183	6E133	6E183
	24"	6135G	6185G	-	6185M	6C135	6C185	6E135	6E185

Guardian 2 Tier Lockers									
		Standard Door 16 ga.*		Medallion Door 16 ga.*		Guardian PLUS 14 ga.		Defiant II Latch - 14 ga.	
Overall Height		60"	72"	60"	72"	60"	72"	60"	72"
Opening Height		30"	36"	30"	36"	30"	36"	30"	36"
Width	Depth	Cat. No.	Cat. No.	Cat. No.	Cat. No.	Cat. No.	Cat. No.	Cat. No.	Cat. No.
12"	12"	6211G	6231G	6211M	6231M	6C211	6C231	6E211	6E231
	15"	6213G	6233G	6213M	6233M	6C213	6C233	6E213	6E233
	18"	6215G	6235G	6215M	6235M	6C215	6C235	6E215	6E235
	21"	6217G	6218G	6217M	6218M	6C217	6C218	6E217	6E218
	24"	-	6220G	-	6220M	-	-	-	6E220
15"	12"	6227G	6239G	-	6239M	6C227	6C239	6E227	6E239
	15"	6229G	6241G	-	6241M	6C229	6C241	6E229	6E241
	18"	6237G	6243G	-	6243M	6C237	6C243	6E237	6E243
	21"	6257G	6245G	-	6245M	6C257	6C245	6E257	6E245
	24"	-	6246G	-	6246M	-	-	-	-
18"	18"	-	6247G	-	-	-	6C247	6E281	6E247
	21"	-	6249G	-	-	-	6C249	6E283	6E249

Guardian 3 Tier Lockers									
		Standard 16 ga.		Medallion 16 ga.	Guardian PLUS 14 ga.		Defiant II Latch 14 ga.		
Overall Height		60"	72"	72"	60"	72"	60"	72"	
Opening Height		20"	24"	24"	20"	24"	20"	24"	
Width	Depth	Cat. No.	Cat. No.	Cat. No.	Cat. No.	Cat. No.	Cat. No.	Cat. No.	
12"	12"	6407G	6419G	6419M	6C407	6C419	6E407	6E419	
	15"	6409G	6421G	6421M	6C409	6C421	6E409	6E421	
	18"	6411G	6423G	6423M	6C411	6C423	6E411	6E423	
	21"	6449G	6499G	6499M	6C449	6C499	6E449	6E499	
15"	12"	-	6425G	-	-	6C425	-	6E425	
	15"	6451G	6427G	-	-	6C427	6E451	6E427	
	18"	6453G	6429G	-	-	6C429	6E453	6E429	
	21"	6455G	6437G	-	-	6C437	6E455	6E437	

Guardian 2 Person Lockers			
		Standard 16 ga.	Medallion 16 ga.
Overall Height		72"	72"
Opening Height		52"	52"
Width	Depth	Cat. No.	Cat. No.
15"	15"	6501G	6501M
	18"	6503G	6503M

\* Standard Guardian & Medallion Option doors less than 12" wide are 18 gauge.

NOTE: 1, 2 & 3 Tier, 2 Person and Duplex lockers are ordered by the FRAME. Overall heights do NOT include legs.

## At a Glance

- Knocked down construction
- Diamond perforations on door and sides
- 14 ga. door, 16 ga. body & 18 ga. back
- Classic III or Defiant II pocket available on 1, 2 and 3 tier
- Friction on 4 through 9 tier

### Ventilation Options

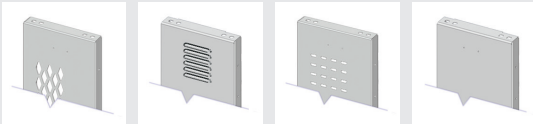

Diamond Shaped (S)    Standard Louvers (O)    Mini Louvers (O)    Solid Door (O)

### Door Handle Options

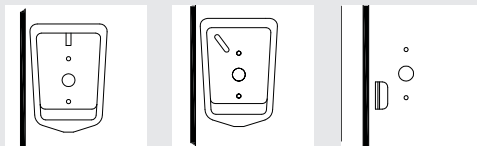

Classic III Recessed (S)    Defiant II Recessed (O)    Friction Catch (SB)

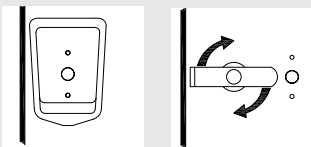

Defiant II Rotary Recessed (A)    Cremone Turn Handle (A) On most 1, 2 and 3 Tier models

S = Standard    O = Optional\*    A = Available\*  
 SB = Std. on Box Lockers    OB = Optional on Box Lockers\*

\*additional charges may apply

For Invincible II specifications, see page 56.  
 For Defiant Doors, see page 61.



Penco's Invincible II athletic lockers are an exceptionally attractive and durable choice for gym lockers. Ideal for applications that require a high degree of ventilation and strength, or where visual inspection of locker contents is desired.

Doors are made from heavy 14 gauge steel. Sides, tops, bottoms and shelves are 16 gauge steel. Backs are 18 gauge. Doors and sides are perforated with a diamond-shaped pattern allowing maximum air circulation while maintaining security. Solid doors are an option.

**Invincible II** lockers come in a variety of styles: 1 tier, 2 tier and 3 tier all have as standard the Classic III stainless steel recessed pocket and multi-point latching. Standard 4, 5, 6, 8 and 9 tier box lockers doors have a padlock hasp and a friction catch, and will accept built-in locks. Available at extra cost is a spring-loaded catch.

Both 2 & 3 tier lockers have horizontal frame members welded between the doors for added strength and security. 24" wide lockers have full width doors. If slope tops are required, use hoods. All lockers accept built-in locks or padlocks and have rubber bumpers on the frame to help reduce noise.



1 Tier    2 Tier    3 Tier    4 Tier    5 Tier    6 Tier    8 Tier    9 Tier



## Sizes and Dimensions

Invincible II 1 Tier Lockers					
		Std. Cat. No.		Defiant II	
Overall Ht.		-	-	-	-
Opening Ht.		60"	72"	60"	72"
Width	Depth	Cat. No.	Cat. No.	Cat. No.	Cat. No.
9"	12"	6A101	6A107	-	-
	15"	6A103	6A109	-	-
	18"	6A105	6A111	-	-
12"	12"	6A129	6A157	6P129	6P157
	15"	6A131	6A159	6P131	6P159
	18"	6A135	6A161	6P135	6P161
	21"	6A133	6A163	-	-
15"	15"	6A143	6A169	6P143	6P169
	18"	6A145	6A171	6P145	6P171
	21"	6A147	6A173	6P147	6P173
	24"	-	6A172	-	-
18"	15"	6A149	6A175	6P149	6P175
	18"	6A151	6A177	6P151	6P177
	21"	6A153	6A179	6P153	6P179
	24"	6A155	6A181	6P155	6P181
24"	15"	-	6A182	-	-
	18"	6A117	6A123	6P117	6P123
	21"	6A119	6A125	6P119	6P125
	24"	6A121	6A127	6P121	6P127

Invincible II 2 Tier Lockers					
		Std. Cat. No.		Defiant II	
Overall Ht.		60"	72"	60"	72"
Opening Ht.		30"	36"	30"	36"
Width	Depth	Cat. No.	Cat. No.	Cat. No.	Cat. No.
9"	12"	-	-	-	-
	15"	-	-	-	-
	18"	-	-	-	-
12"	12"	6A213	6A245	6P213	6P245
	15"	6A215	6A247	6P215	6P247
	18"	6A217	6A249	6P217	6P249
	21"	-	6A251	-	-
15"	15"	6A225	6A257	6P225	6P257
	18"	6A239	6A259	6P239	6P259
	21"	6A241	6A261	6P241	6P261
	24"	-	6A253	-	-
18"	15"	6A223	6A263	6P223	6P263
	18"	6A227	6A265	6P227	6P265
	21"	6A229	6A267	6P229	6P267
	24"	6A231	6A269	6P231	6P269
24"	15"	-	-	-	-
	18"	6A233	6A271	6P233	6P271
	21"	6A235	6A273	6P235	6P273
	24"	6A237	6A275	6P237	6P275

Invincible II 3 Tier Lockers					
		Std. Cat. No.		Defiant II	
Overall Ht.		60"	72"	60"	72"
Opening Ht.		20"	24"	20"	24"
Width	Depth	Cat. No.	Cat. No.	Cat. No.	Cat. No.
9"	12"	-	-	-	-
	15"	-	-	-	-
	18"	-	-	-	-
12"	12"	6A287	6A281	6P287	6P281
	15"	6A289	6A283	6P289	6P283
	18"	6A291	6A285	6P291	6P285
	21"	-	-	-	-
15"	15"	6A293	6A301	6P293	6P301
	18"	6A295	6A303	6P295	6P303
	21"	6A297	6A305	6P297	6P305
	24"	-	-	-	-
18"	15"	-	-	-	-
	18"	6A220	6A221	-	-
	21"	-	-	-	-
	24"	-	-	-	-
24"	15"	-	-	-	-
	18"	-	-	-	-
	21"	-	-	-	-
	24"	-	-	-	-

Invincible II 4, 5, 6, 8 & 9 Tier Box Lockers								
		4 Tier		5 Tier		6 Tier	8 Tier	9 Tier
Overall Height		60"	72"	60"	72"	72"	72"	72"
Opening Height		15"	18"	12"	14-2/5"	12"	9"	8"
Width	Depth	Cat. No.	Cat. No.	Cat. No.	Cat. No.	Cat. No.	Cat. No.	Cat. No.
12"	12"	6A307	6A319	6A351	6A363	6A375	6A393	6A407
	15"	6A309	6A321	6A353	6A365	6A377	6A395	6A409
	18"	6A311	6A323	6A355	6A367	6A379	6A397	6A411
	21"	-	-	-	-	6A381	-	-
15"	15"	6A313	6A331	6A357	6A369	6A383	6A401	6A413
	18"	6A315	6A335	6A359	6A371	6A385	6A403	6A415
	21"	-	-	6A361	6A373	6A389	6A405	6A417
18"	18"	-	-	6A419	6A445	6A423	-	-
	21"	-	-	6A421	6A447	6A425	-	-

Group Ends for Invincible II Lockers					
		Perforated Single Row		Solid Single Row	
Height	Depth	1 - 6 Tier Cat. No.	8 & 9 Tier Cat. No.	1 - 6 Tier Cat. No.	8 & 9 Tier Cat. No.
36-1/2"	12"	603600V	-	603601S	-
	15"	603602V	-	603603S	-
	18"	603704V	-	603605S	-
48-1/2"	12"	603606V	-	603607S	-
	15"	603608V	-	603609S	-
	18"	603700V	-	603701S	-
60"	12"	602100V	-	602101S	-
	15"	602102V	-	602103S	-
	18"	602104V	-	602105S	-
	21"	602106V	-	602107S	-
	24"	602108V	-	602109S	-
72"	12"	602110V	602120V	602111S	602121S
	15"	602112V	602122V	602113S	602123S
	18"	602114V	602124V	602115S	602125S
	21"	602116V	602126V	602117S	602127S
	24"	602118V	-	602119S	-

### Ordering Group Ends for Invincible II Lockers

You must order a Group End to finish each group of Invincible II lockers, regardless of length of each group or row. Specify Perforated or Solid.

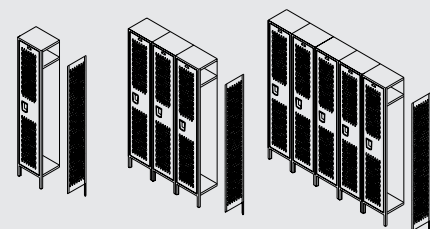

1 Basic Unit  
1 Group End

3 Basic Units  
1 Group End

5 Basic Units  
1 Group End

# Welded Gen2

## At a Glance

- 16 ga. body & 18 ga. back for durability
- 14 ga. door and Classic III pocket standard
- Optional Defiant II single point latching
- Ships fully assembled

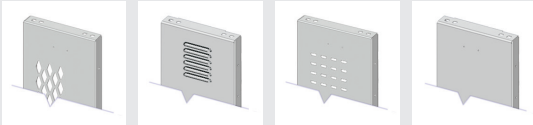

Diamond Shaped (S)    Standard Louvers (O)    Mini Louvers (O)    Solid Door (O)

## Base Options



No Legs or Base (S)    Channel Base (O)

## Door Handle Options

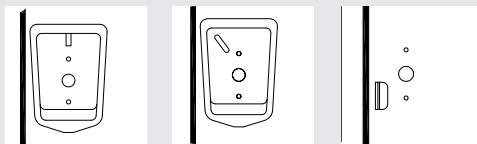

Classic III Recessed (S)    Defiant II Recessed (O)    Friction Catch (SB)

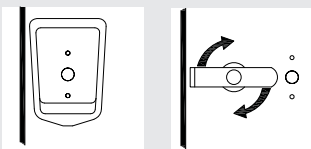

Defiant II Rotary Recessed (O)    Cremone Turn Handle (A) On most 1, 2 and 3 Tier models

S = Standard    O = Optional\*    A = Available\*  
 SB = Standard on Box Lockers    OB = Optional on Box Lockers\*

\*additional charges may apply

For Welded Gen2 specifications, see page 58.  
 For Defiant Doors, see page 61.



## The Welded Gen2 Alternative

Welded Gen2 lockers offer superior resistance to hard use and abuse. All body parts are welded into a single rigid unit to resist damage for the life of the product. The door frame and locker side are 16 gauge. The doors are made from 14 gauge steel and include a continuous hinge. Sides, tops, bottoms and shelves are 16 gauge steel. Backs are 18 gauge.

Since Welded Gen2 lockers are shipped pre-assembled, the time and expense of on-site installation is greatly reduced. This is a great help where labor is either extremely expensive, or hard to find. Groupings will be determined by Penco based upon the floor plan layout drawings submitted with the order. Maximum group width is usually 54" for lockers with a depth up to 18". For lockers over the depth of 18" the groups shall not exceed 48" in total width. If site conditions restrict maximum group width, please advise.

Welded Gen2 lockers are available as standard in ventilated models with diamond-shaped perforations in the doors and sides for maximum visibility and ventilation, or with solid door and side construction, with or without door louvers. The perforated models are ideal for heavy duty athletic use, where ventilation is important to aid the drying of athletic gear.

Standard construction is flat top without legs. Lockers can be ordered with 4" high and 6" high, 16 gauge Channel Base as an option.

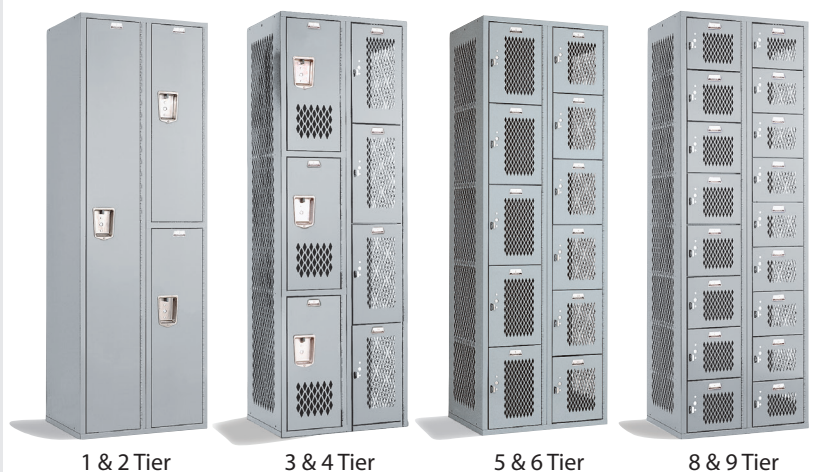

Welded Gen2 Classic III 1 Tier Lockers					
Opening Height		36.5"	48.5"	60"	72"
Unit Width	Unit Depth	Cat. No.	Cat. No.	Cat. No.	Cat. No.
9"	12"	-	-	6G101	6G107
	15"	-	-	6G103	6G109
	18"	-	-	6G105	6G111
12"	12"	6G011	6G017	6G129	6G157
	15"	6G013	6G019	6G131	6G159
	18"	6G015	6G021	6G135	6G161
	18"	-	-	6G133	6G163
	24"	-	-	6G137	6G167
15"	12"	-	-	6G141	6G165
	15"	-	-	6G143	6G169
	18"	-	-	6G145	6G171
	21"	-	-	6G147	6G173
	24"	-	-	6G112	6G172
18"	12"	-	-	6G501	6G500
	15"	-	-	6G149	6G175
	18"	-	-	6G151	6G177
	21"	-	-	6G153	6G179
	24"	-	-	6G155	6G181
24"	15"	-	-	-	6G182
	18"	-	-	6G117	6G123
	21"	-	-	6G119	6G125
	24"	-	-	6G121	6G127

Welded Gen2 Classic III 2 Tier Lockers			
Overall Height		60"	72"
Opening Height		30"	36"
Unit Width	Unit Depth	Cat. No.	Cat. No.
12"	12"	6G213	6G245
	15"	6G215	6G247
	18"	6G217	6G249
	21"	6G206	6G251
15"	24"	6G207	6G252
	12"	6G208	6G228
	15"	6G225	6G257
	18"	6G239	6G259
18"	21"	6G241	6G261
	24"	6G212	6G253
	12"	-	6G508
	15"	6G223	6G263
24"	18"	6G227	6G265
	21"	6G229	6G267
	24"	6G231	6G269
24"	18"	6G233	6G271
	21"	6G235	6G273
	24"	6G237	6G275

Welded Gen2 3 Tier Lockers					
		Std. Cat. No.		Defiant II Latch	
Overall Height		60"	72"	60"	72"
Opening Height		20"	24"	20"	24"
Unit Width	Unit Depth	Cat. No.	Cat. No.	Cat. No.	Cat. No.
12"	12"	6G287	6G281	6GD287	6GD281
	15"	6G289	6G283	6GD289	6GD283
	18"	6G291	6G285	6GD291	6GD285
	21"	6G306	6G326	-	-
	24"	6G292	6G327	-	-
15"	12"	6G308	6G328	-	-
	15"	6G293	6G301	6GD293	6GD301
	18"	6G295	6G303	6GD295	6GD303
	21"	6G297	6G305	6GD297	6GD305
18"	24"	6G312	6G332	-	-
	12"	-	-	-	-
	15"	-	-	-	-
	18"	6G220	6G221	-	6GD221
	21"	6G314	6G334	-	6GD334
24"	6G222	6G224	-	6GD224	

Welded Gen2 4, 5, 6, 8 & 9 Tier Box Lockers								
		4 Tier		5 Tier		6 Tier	8 Tier	9 Tier
Overall Ht.		60"	72"	60"	72"	72"	72"	72"
Opening Ht.		15"	18"	12"	14-2/5"	12"	9"	8"
Unit Width	Unit Depth	Cat. No.	Cat. No.	Cat. No.	Cat. No.	Cat. No.	Cat. No.	Cat. No.
12"	12"	6G307	6G319	6G351	6G363	6G375	6G393	6G407
	15"	6G309	6G321	6G353	6G365	6G377	6G395	6G409
	18"	6G311	6G323	6G355	6G367	6G379	6G397	6G411
	21"	6G406	6G426	6G531	6G526	6G381	-	-
	24"	6G316	6G427	6G532	6G527	6G627	-	-
15"	12"	6G408	6G428	6G356	6G528	6G628	6G828	6G928
	15"	6G313	6G331	6G357	6G369	6G383	6G401	6G413
	18"	6G315	6G335	6G359	6G371	6G385	6G403	6G415
	21"	6G317	6G431	6G361	6G373	6G389	-	6G417
18"	24"	6G412	6G432	6G534	6G374	6G541	-	-
	18"	-	-	6G419	6G445	6G423	-	-
	21"	-	-	6G421	6G447	6G425	-	-

## At a Glance

- Knocked Down or Welded construction
- Open Fronts and smooth Frame Channels
- 2 lockable compartment options
- 18 or 24-inch widths available
- 18, 21 and 24-inch depths available

## Ventilation

Diamond Perforated Sides (Solid Sides Optional)

## Door Handle Option

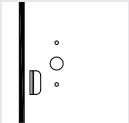

On models equipped with a Security Box

Friction Catch (O)

## Accessories



Locking Security Box (O)



Footlocker (O)

O = Optional\* \*additional charges may apply

For Stadium specifications, see pages 62-63.

## The Right Locker for Athletes and Their Equipment

Penco's Stadium lockers are ideally suited for athletic team rooms, firefighter's equipment or any other application where easy access to uniforms and/or equipment is required.

All Stadium lockers have a Full Width Shelf and a Coat Rod with Hooks. A lockable Security Box and Footlocker are optional. The open Front and optional Diamond Perforated Sides offer full ventilation. All are 1 Tier and 1 wide.

The front of the optional Footlocker is recessed for an external padlock. The Footlocker design saves floor space by eliminating the clutter of open locker doors and the need for separate locker room benches.

Stadium lockers are available in Knocked Down or Welded construction in any of Penco's 24 brilliant colors.



## Ordering Matrix

### Knocked Down \*Order welded for factory assembled Stadium locker.

Patriot <b>STADIUM - KD</b> Locker Part Number Identification Matrix										
S	K	#	#	#	*	*	N	*	*	
Product	Type	Width	Depth	Height	LH Side Vent	RH Side Vent	Channel Base	Security Box	Footlocker	
Product	Type	# Width	# Depth	# Height	* LH Side Vent	* RH Side Vent	* Channel Base	* Sec Box	* Footlocker	
S = Stadium	K = KD	18	18	72	D = Diamond	D = Diamond	N = No channel base	B = Sec Box	F = Footlocker	
		24	18	72						
		24	21	72	S = Solid	S = Solid		N = No Sec Box	N = No Footlocker	
		24	24	72						
Part Number Examples:										
<b>SK242472SSNBN</b>		Stadium - KD - 24" wide x 24" deep x 72" high - Solid LH Side - Solid RH Side - Security Box - No footlocker								
<b>SK241872DDNBF</b>		Stadium - KD - 24" wide x 24" deep x 72" high - Diamond LH Side - Diamond RH Side - Security Box - Footlocker								

Locker Shell Ordering Guide	
1	Gear, Duty, TA50 and RRDL are ALL WITH Doors
2	Stadium and Turnout are ALL WITHOUT Door
3	ALL Stadium locker part numbers are based on a specific configuration and are not able to be changed, order Turnout if a different configuration is needed
4	ALL Stadium lockers are 1 Tier
5	ALL Stadium lockers are 1 Wide
6	Both KD and Welded Stadium lockers are available with channel base, order channel base separately for KD

### Welded

Patriot <b>STADIUM - Welded</b> Locker Part Number Identification Matrix										
S	W	#	#	#	*	*	N	*	*	
Product	Type	Width	Depth	Height	LH Side Vent	RH Side Vent	Channel Base	Security Box	Footlocker	
Product	Type	# Width	# Depth	# Height	* LH Side Vent	* RH Side Vent	* Channel Base	* Sec Box	* Footlocker	
S = Stadium	W = Welded	18	18	72	D = Diamond	D = Diamond	4 = 4 inch high	B = Sec Box	F = Footlocker	
		24	18	72			6 = 6 inch high			
		24	21	72	S = Solid	S = Solid	N = No channel base	N = No Sec Box	N = No Footlocker	
		24	24	72						
Part Number Examples:										
<b>SW242472SSNBN</b>		Stadium - Welded - 24" wide x 24" deep x 72" high - Solid LH Side - Solid RH Side - No channel base - Security Box - No footlocker								
<b>SW242172DD4BF</b>		Stadium - Welded - 24" wide x 21" deep x 72" high - Diamond LH Side - Diamond RH Side - 4 inch high channel base - Security Box - Footlocker								



## Fully Framed TA-50 Locker

Penco's TA-50 locker is government and military inspired. Available in Knocked Down or Welded construction, this heavy-duty locker is designed to offer a superior level of security and durability while providing efficient storage for bulky military-grade gear.



- Tubular boxed frame provides rigid construction
- 14 gauge doors with continuous hinge provide full access and secure storage
- Flattened Expanded Metal sides of this tactical TA-50 locker allows for maximum ventilation

- 78" overall locker height
- 36", 42", and 48" widths available
- 4" or 6" high Channel Base available

## Fully Framed TA-50 Locker

- True Fully Framed construction offers better rigidity
- 36, 42, and 48-inch widths available
- All are 24" deep and 78" high
- Ultra Cremone Recessed Handle for a safer, cleaner look and less freight damage
- Double Doors available in solid, diamonds, or louvers
- Knocked Down or Welded construction
- 4 or 6-inch high Channel Base optional
- All TA-50 lockers are 1 tier
- All TA-50 lockers are 1 wide
- Solid or Flattened Expanded Metal sides available
- 16-gauge continuous hinge



For TA-50 specifications, see pages 64-65.



# PATRIOT<sup>®</sup> TA-50 Identification Matrix

## Knocked Down and Welded

\*Order welded for factory assembled TA-50 locker.

Locker Shell Ordering Guide	
1	Gear, Duty, TA50 and RRDL are ALL WITH Doors
2	Stadium and Turnout are ALL WITHOUT Doors
3	ALL TA50 lockers are 1 Tier
4	ALL TA50 lockers are 1 Wide
5	Both KD and Welded TA50 lockers are available with channel base, order channel base separately for KD
6	TA50 lockers are based on a specific configuration, all TA50 lockers come with Hat Shelf, Coat Rod and Hooks

### Patriot TA50 - KD Locker Part Number Identification Matrix

M	K	#	#	#	*	*	N	D	C	*
Product	Type	Width	Depth	Height	LH Side Vent	RH Side Vent	Channel Base	Door type	Handle Type	Door Vent



Product	Type	# Width	# Depth	# Height	* LH Side Vent	* RH Side Vent	* Channel Base	* Door Type	* Handle Type	* Door Vent
M = TA50 Military	K = KD	36	24	78	E = Expanded	E = Expanded	N = No channel base	D - Double	C = Ultra Cremone Recessed Handle	D = Diamond
		42			S = Solid	S = Solid				S = Solid
		48								L = Louvers

#### Part Number Examples:

<b>MK362478EEDCD</b>	(M) TA50 - KD - 36" wide x 24" deep x 78" high - Expanded LH Side - Expanded RH Side - Double Door - Ultra Cremone Recessed Handle - Diamond Door
<b>MK422478SSDCL</b>	(M) TA50 - KD - 42" wide x 24" deep x 78" high - Solid LH Side - Solid RH Side - Double Door - Ultra Cremone Recessed Handle - Louvers Door

### Patriot TA50 - Welded Locker Part Number Identification Matrix

M	W	#	#	#	*	*	N	D	C	*
Product	Type	Width	Depth	Height	LH Side Vent	RH Side Vent	Channel Base	Door type	Handle Type	Door Vent



Product	Type	# Width	# Depth	# Height	* LH Side Vent	* RH Side Vent	* Channel Base	* Door Type	* Handle Type	* Door Vent
M = TA50 Military	W = Welded	36	24	78	E = Expanded	E = Expanded	4 = 4 inch high	D - Double	C = Ultra Cremone Recessed Handle	D = Diamond
		42			S = Solid	S = Solid	6 = 6 inch high			S = Solid
		48					N = No channel base			L = Louvers

#### Part Number Examples:

<b>MW422478EEDCD</b>	(M) TA50 - Welded - 42" wide x 24" deep x 78" high - Expanded LH Side - Expanded RH Side - Double Door - Ultra Cremone Recessed Handle - Diamond Door
<b>MW482478SSDCL</b>	(M) TA50 - Welded - 48" wide x 24" deep x 78" high - Solid LH Side - Solid RH Side - Double Door - Ultra Cremone Recessed Handle - Louvers Door



## Fully Framed Gear Locker

A properly equipped, double-door Patriot Gear locker can be the ideal solution for a variety of specialized storage challenges. The ample storage areas at both top and bottom of the 24 - 48 inch-wide and 72-inch high locker leaves nearly four feet between the shelves for hanging uniforms and other gear.

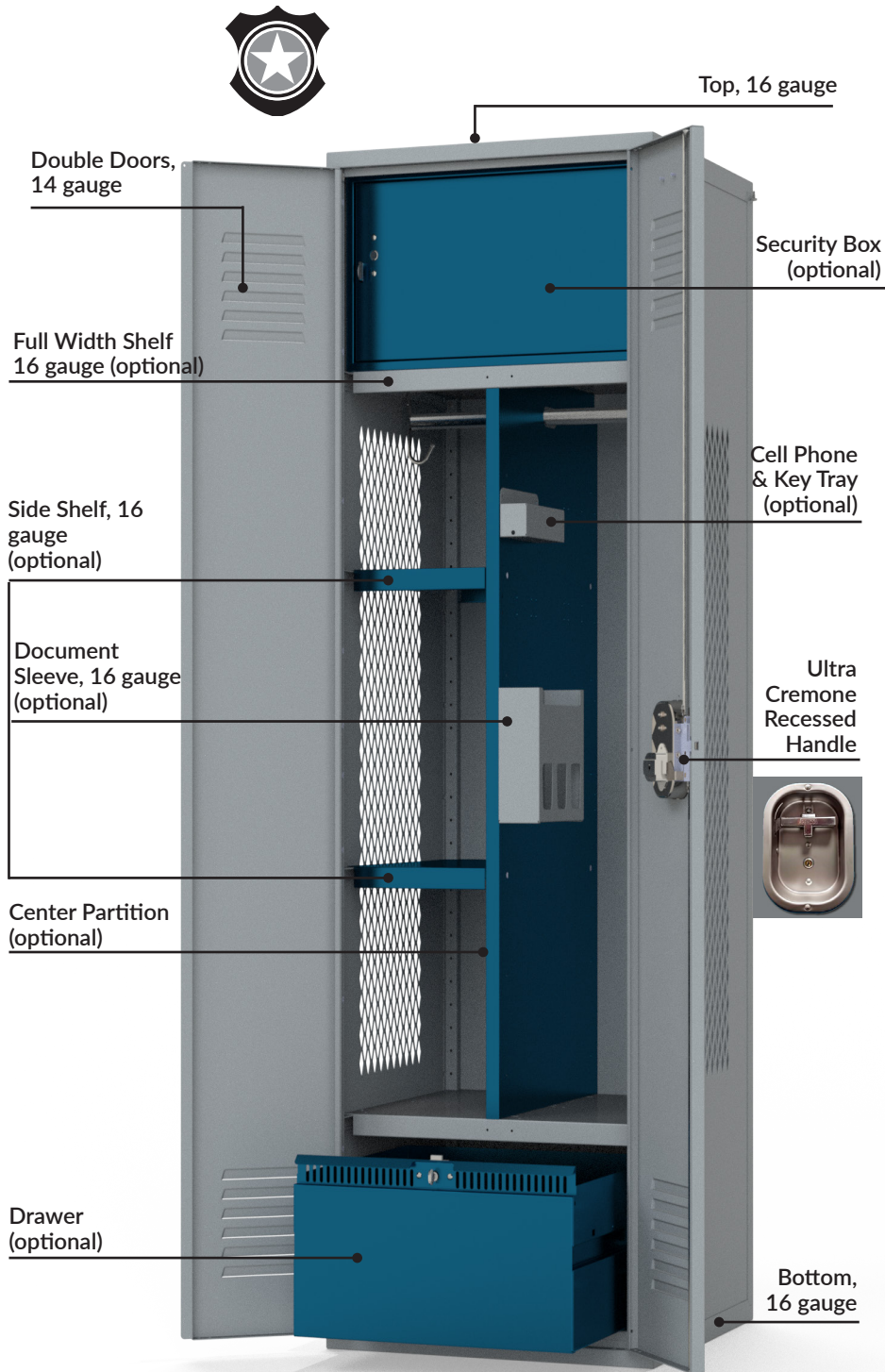

### Distinguishing Features:

- True Fully Framed construction offers better rigidity
- Offered in Knocked Down or Welded construction
- 4 or 6-inch high Channel Base available
- 72 or 78-inch heights available
- 18-inch depth available with 18 or 24-inch widths
- 24-inch depth available with 18, 24, 30, 36, 42, or 48-inch widths
- Ultra Cremone Recessed Handle for a safer, cleaner look and less freight damage
- High degree of configurability



Patriot Gear locker is shown above in two-tone colors. Contact a Penco Representative for more details.

## Fully Framed Gear Locker

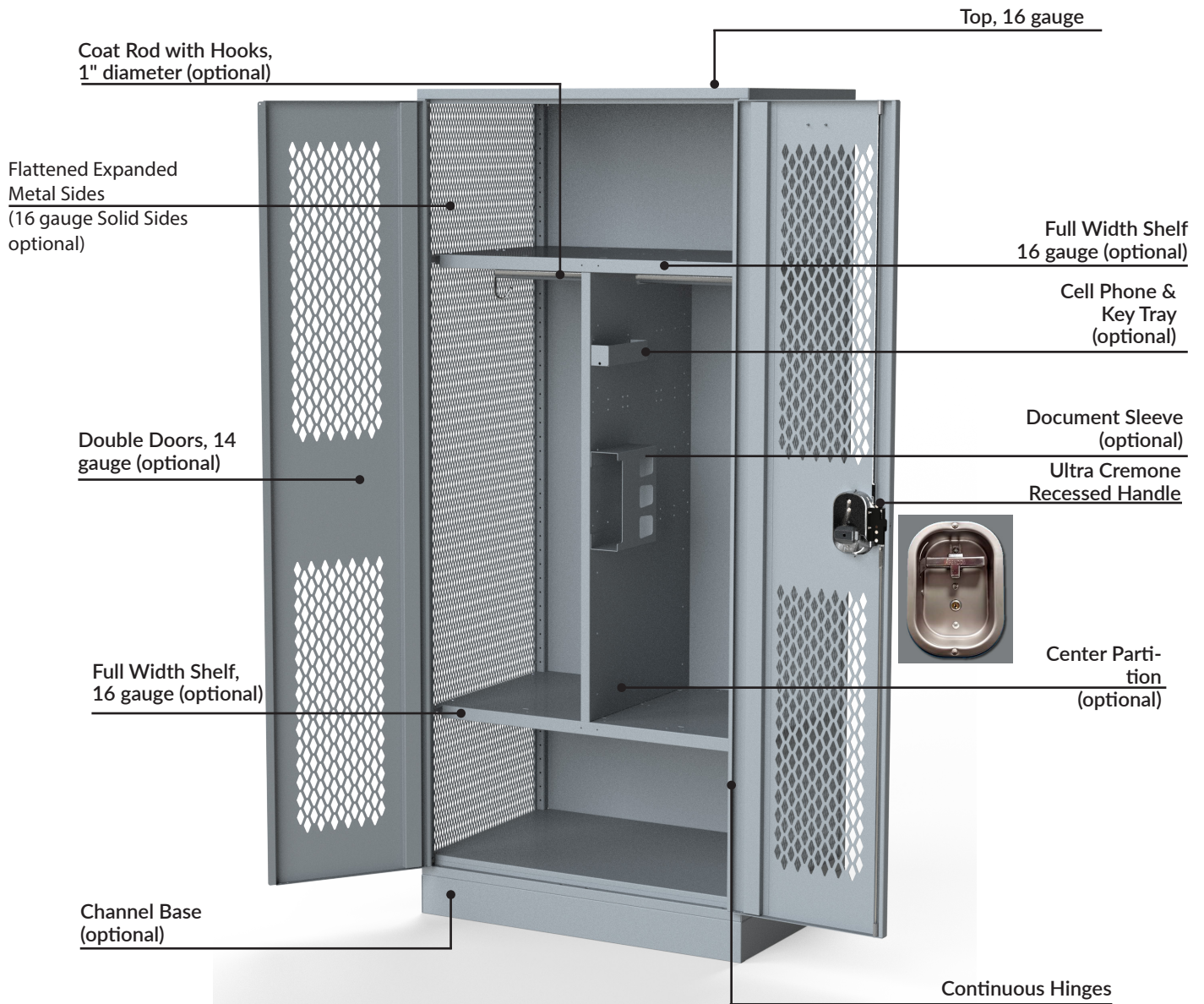

For Gear specifications, see pages 66-69.

Gear Locker Easy-Order Pre-Configurations					
(Based on popular preferences. For custom configurations, see ordering matrix on pages 10 & 11)					
Part Number	Type	Width	Features	Accessories	Drawing
6GK36247201	KD	36	Solid Sides, No Channel Base, Double Doors with Louvers, Ultra Cremone Recessed Handle, 24" deep, 72" high	Shelf, 2 Coat Rods, Hooks, Partition, 2 Drawers	
6GK48247201		48			
6GW36247201	Welded	36			
6GW48247201		48			
6GK36247202	KD	36	Solid Sides, No Channel Base, Double Doors with Louvers, Ultra Cremone Recessed Handle, 24" deep, 72" high	Shelf, 1 Coat Rods, Hooks, 2 Drawers	
6GK48247202		48			
6GW36247202	Welded	36			
6GW48247202		48			
6GK24247205	KD	24	Flattened Expanded Metal Sides, No Channel Base, Double Doors with Louvers, Ultra Cremone Recessed Handle, 24" deep, 72" high	Shelf, Coat Rod, Hooks, Security Box	
6GK48247205		48			
6GW24247205	Welded	24			
6GW48247205		48			
6GK36247206	KD	36	Diamond Sides, No Channel Base, Double Doors with Louvers, Ultra Cremone Recessed Handle, 24" deep, 72" high	Shelf, Coat Rod, Hooks, Two Security Boxes	
6GK48247206	KD	48			
6GW36247206	Welded	36			
6GW48247206	Welded	48			
6GK24247207	KD	24	Flattened Expanded Metal Sides, No Channel Base, Double Doors with Louvers, Ultra Cremone Recessed Handle, 24" deep, 72" high	Shelf, Coat Rod, Hooks, 3 Half Shelves	
6GK36247207	KD	36			
6GW24247207	Welded	24			
6GW36247207	Welded	36			
6GK24247208	KD	24	Flattened Expanded Metal Sides, No Channel Base, Double Doors with Louvers, Ultra Cremone Recessed Handle, 24" deep, 72" high	Shelf, Coat Rod, Hooks	
6GK36247208	KD	36			
6GW24247208	Welded	24			
6GW36247208	Welded	36			

## Knocked Down



Locker Shell Ordering Guide	
1	Gear, Duty, TA50 and RRDL are ALL WITH Doors
2	Stadium and Turnout are ALL WITHOUT Doors
3	Lockers over 24 inches wide are only available in 24 inches in depth
4	ALL Gear lockers come with ONLY the Ultra Cremone Recessed handle. No other handle is available at this time.
5	ALL 18" wide Gear lockers are Single Door ONLY. ALL 24" wide Gear lockers are available in both Single Door and Double Door. All Gear lockers over 24" wide are Double Door ONLY.
6	Diamond Sides are NOT available for 78" high lockers
7	ALL Gear lockers are 1 Tier
8	ALL Gear lockers are 1 Wide
9	Both KD and Welded Gear lockers are available with channel base
10	Gear lockers are totally configurable, for that reason, hat shelf and coat rods need to be order separately

\*Order welded for factory assembled Gear locker.

Patriot GEAR - KD Locker Part Number Identification Matrix											
G	K	#	#	#	*	*	N	*	*	*	*
Product	Type	Width	Depth	Height	LH Side Vent	RH Side Vent	Channel Base	Door type	Handle Type	Door Vent	
Product	Type	# Width	# Depth	# Height	* LH Side Vent	* RH Side Vent	* Channel Base	* Door Type	* Handle Type	* Door Vent	
G = Gear	K = KD	18	18	72 and 78	D = Diamond (see #6 above)	D = Diamond (see #6 above)	N = No channel base	S = Single	C = Ultra Cremone Recessed Handle	D = Diamond	
			24		E = Expanded	E = Expanded					S = Solid
		24	18		S = Solid	S = Solid		D - Double		L = Louvers	
			30								
			36								
			42								
48											
<b>Part Number Examples:</b>											
<b>GK362472DSDCL</b>					Gear - KD - 36" wide x 24" deep x 72" high - Diamond LH Side - Solid RH Side - Double door - Ultra Cremone Recessed Handle - Louver Door						

## Welded



Locker Shell Ordering Guide	
1	Gear, Duty, TA50 and RRDL are ALL WITH Doors
2	Stadium and Turnout are ALL WITHOUT Door
3	Lockers over 24 inches wide are only available in 24 inches in depth
4	ALL Gear lockers come with ONLY the Ultra Cremone Recessed Handle. No other handle is available at this time.
5	ALL 18" wide Gear lockers are Single Door ONLY. All 24" wide Gear lockers are available in both Single Door and Double Door. All Gear lockers over 24" wide are Double Door ONLY.
6	Diamond Sides are NOT available for 78" high lockers
7	ALL Gear lockers are 1 Tier
8	ALL Gear lockers are 1 Wide
9	Both KD and Welded Gear lockers are available with Channel Base
10	Gear lockers are totally configurable, for that reason, hat shelf and coat rods need to be order separately

Patriot GEAR - Welded Locker Part Number Identification Matrix											
G	W	#	#	#	*	*	N	*	*	*	
Product	Type	Width	Depth	Height	LH Side Vent	RH Side Vent	Channel Base	Door type	Handle Type	Door Vent	
Product	Type	# Width	# Depth	# Height	* LH Side Vent	* RH Side Vent	* Channel Base	* Door Type	* Handle Type	* Door Vent	
G = Gear	W = Welded	18	18	72 and 78	D = Diamond (see #6 above)	D = Diamond (see #6 above)	4 = 4 inch high	S = Single	C = Ultra Cremone Recessed Handle	D = Diamond	
			24								E = Expanded
		24	24		S = Solid	S = Solid	N = No channel base	D - Double		L = Louvers	
											30
											36
											42
48											

**Part Number Examples:**

**GW362472DS4DCL**

Gear - Welded - 36" wide x 24" deep x 72" high - Diamond LH Side - Solid RH Side - 4" Channel Base - Double Door - Ultra Cremone Recessed Handle - Louver Door

## Fully Framed Turnout Locker



Turnout lockers give you the advantage of instant access to mission gear, and Patriot accessories like drawers, security boxes or footlockers give you secure storage for items that are best kept under lock and key.

Whether the Patriot you specify has doors or not, the same flexibility is built into each one. Gear and Turnout accessories are designed for use in either type locker.

Balance the advantage of an open front locker with secure storage by adding a Security Box, Drawers or a Footlocker.

Full Width Shelf, 16 gauge (optional)

Coat Rod with Hooks (optional)

Top, 16 gauge

Security Box (optional)

Channel Base 14 gauge (optional)



For Turnout **specifications**, see pages 70-71.

## Fully Framed Turnout Locker

The key to any turnout locker is the ability to grab and go. The Patriot Turnout Locker puts everything from flight gear to EMS equipment within reach. The Patriot Turnout Locker shares the same heavy-gauge steel construction as Gear lockers but have an open front and smooth frame, allowing users to retrieve equipment in a flash.



Top, 16 gauge

### Distinguishing Features:

- True fully framed construction offers better rigidity
- Offered in Knocked Down or Welded construction
- 4 or 6-inch high Channel Base available
- Open front and hemmed frame
- 24-inch deep available in 18, 24, 30, 36, 42, or 48-inch widths
- 18-inch deep locker available in 18 or 24-inch widths
- Available in 72 or 78-inch heights
- Number plates mount to the shelf face for easy visibility

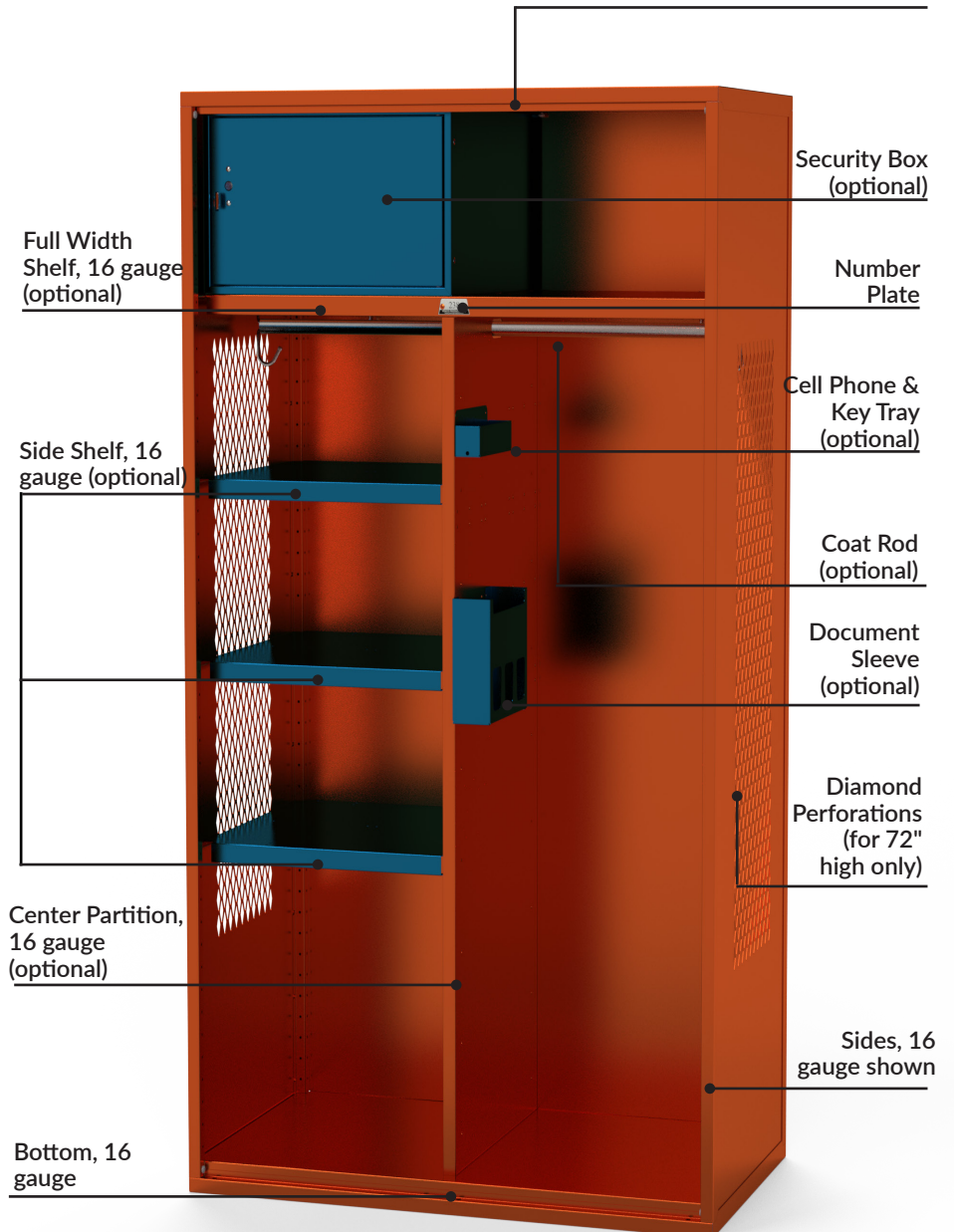

Penco Turnout locker is shown above in two-tone using standard colors. For more information about two-tone lockers, contact your Penco Representative.

## Fully Framed Turnout Identification Matrix

Locker Shell Ordering Guide	
1	Gear, Duty, TA50 and RRDL are ALL WITH Doors
2	Stadium and Turnout are ALL WITHOUT Door
3	Lockers over 24 inches wide are only available in 24 inches in depth
4	If ordering 78" high lockers - Diamond Sides are NOT available

5	ALL Turnout lockers are 1 Tier
6	ALL Turnout lockers are 1 Wide
7	Both KD and Welded Turnout lockers are available with Channel Base
8	Turnout lockers are totally configurable, for that reason, hat shelf and coat rods need to be order separately

### Patriot TURNOUT - KD Locker Part Number Identification Matrix

T	K	#	#	#	*	*	N
Product	Type	Width	Depth	Height	LH Side Vent	RH Side Vent	Channel Base

\*Order Welded for factory assembled Turnout locker.

Product	Type	# Width	# Depth	# Height	* LH Side Vent	* RH Side Vent	* Channel Base
T = Turnout	K = KD	18	72 and 78	18	D = Diamond (see # 4 above)	D = Diamond (see # 4 above)	N = No channel base
				24			
		24		18	E = Expanded	E = Expanded	
				30			
				36	S = Solid	S = Solid	
				42			
48							

#### Part Number Examples:

<b>TK181872DSN</b>	Turnout - KD - 18" wide x 18" deep x 72" high - Diamond LH Side - Solid RH Side
<b>TK482472ESN</b>	Turnout - KD - 48" wide x 24" deep x 72" high - Expanded LH Side - Solid RH Side

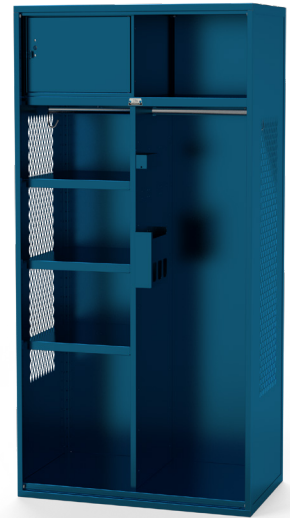

### Patriot TURNOUT - Welded Locker Part Number Identification Matrix

T	W	#	#	#	*	*	*	Locker rules: 1) Gear, Duty, TA50, & RRDL are ALL WITH doors. 2) Stadium & Turnout are ALL WITHOUT doors. 3) Lockers over 24" wide are only available in 24" depth. 4) Diamond sides are NOT available for 78" high lockers. 5) All Turnout lockers are 1 tier and 1 wide. 6) Both KD and Welded Turnout lockers are available with channel base. Order channel base separately for KD. 7) Because Turnout lockers are totally configurable, hat shelf and coat rods need to be ordered separately.
Product	Type	Width	Depth	Height	LH Side Vent	RH Side Vent	Channel Base	

Product	Type	# Width	# Depth	# Height	* LH Side Vent	* RH Side Vent	* Channel Base
T = Turnout	W = Welded	18	72 and 78	18	D = Diamond (see #4 above)	D = Diamond (see #4 above)	4 = 4 inch high
				24			
		24		18	E = Expanded	E = Expanded	
				30			
				36	S = Solid	S = Solid	
				42			
48							





## Fully Framed Duty Locker

With the special needs of law enforcement in mind, the Patriot Duty Locker has a 16-gauge welded shell, 16-gauge drawer, and provides 3.4 cubic feet of usable storage in the drawer base. The 33 or 36-inch deep base optionally accepts individual or continuous lengths of Hardwood Bench Seating.

Security Box  
(optional)

Full Width Shelf  
(optional)

Half Shelf,  
16 gauge  
(optional)

Hardwood Bench  
Seating (required -  
order separately)

Drawer



Coat Rod with  
Hooks, 1" (optional)

Inner Compartment  
Door (optional)

Ultra Cremone  
Recessed Handle

### Distinguishing Features:

- Offered in Knocked Down or Welded construction
- Optional 16 gauge Interior Divider and Side Shelf
- 78 or 90-inch Heights available
- 18 or 24-inch widths available
- Optional Coat Rod and Hooks on garment side
- Optional lockable Security Box
- Back punched for electrical wiring
- Standard Drawer Base for all Duty lockers
- Ultra Cremone Recessed Handle

When timing is crucial, Duty lockers answer the call of law enforcement and security professionals. The customizable features of Duty lockers help users find critical items quickly.

For Duty specifications, see pages 72-75.

Order welded for factory assembled models.

## Duty Locker: Easy-Order Configurations

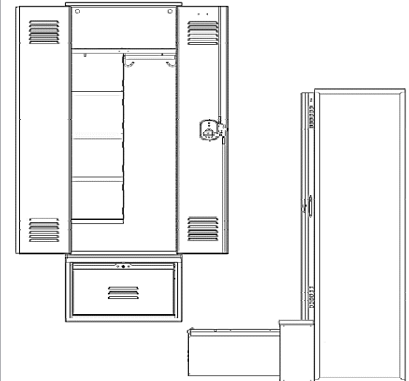
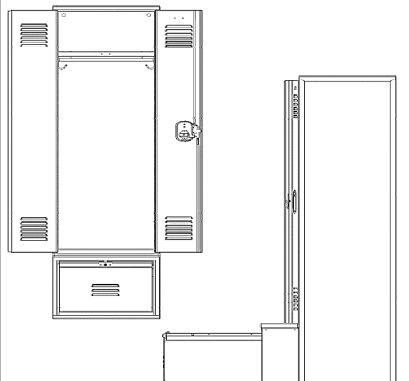
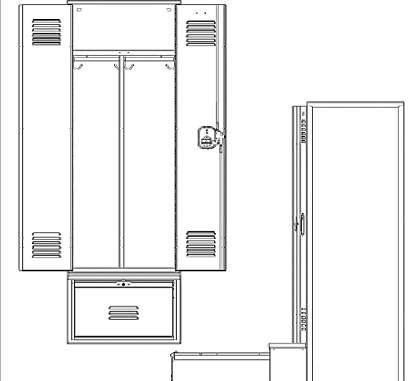
Duty Locker Easy-Order Pre-Configurations				
(Based on popular preferences. For custom configurations, see ordering matrix on pages 17)				
Part Number	Type	Features	Accessories	Drawing
6DK24249009	KD	24" wide, 24" Deep, 90" high. Solid Sides, no Channel Base, Double Doors, Ultra Cremone Recessed Handles, and Louvers	Top Shelf, Coat Rod, Hooks, 4 Half Shelves, 9 inch Extended Front	
6DW24249009	W		Top Shelf, Coat Rod, Hooks, 4 Half Shelves, 9 inch Extended Front	
6DK24249010	KD	24" wide, 24" Deep, 90" high. Solid Sides, no Channel Base, Double Doors, Ultra Cremone Recessed Handles, and Louvers	Top Shelf, Coat Rod, Hooks, 9 inch Extended Front	
6DW24249010	W		Top Shelf, Coat Rod, Hooks, 9 inch Extended Front	
6DK24249011	KD	24" wide, 24" Deep, 90" high. Solid Sides, no Channel Base, Double Doors, Ultra Cremone Recessed Handles, and Louvers	Top Shelf, Center Partition, 2 Coat Rods, Hooks, 9 inch Extended Front	
6DW24249011	W		Top Shelf, Center Partition, 2 Coat Rods, Hooks, 9 inch Extended Front	



Locker Shell Ordering Guide	
1	Gear, Duty, TA50 and RRDL are ALL WITH Doors
2	Stadium and Turnout are ALL WITHOUT Door
3	ALL Duty lockers come with ONLY the Ultra Cremone Recessed Handle. No other handle is available at this time.
4	ALL 18" wide Duty lockers are Single Door ONLY. All 24" wide Duty lockers are available in both Single Door and Double Door.

5	Ordering a Duty locker means a Drawer Base Unit will be provided, if drawer base is not needed order a Gear locker. Examples: 90" high locker is a 72" locker with an nominal 18" high drawer base. 78" high locker will be a 60" locker with an nominal 18" high drawer base.
6	ALL Duty lockers are 1 Tier
7	ALL Duty lockers are 1 Wide
8	ALL Duty lockers come with a Drawer Base Unit
9	Duty lockers are NOT available with channel base because of the drawer base unit
10	Duty lockers are totally configurable, for that reason, hat shelf and coat rods need to be order separately
11	When ordering a Front Extension for the drawer base unit the final depth of the base will be as noted below:
11a	Drawer base unit with a 9" extension on a 24" deep locker will be 33" deep
11b	Drawer base unit with a 12" extension on a 24" deep locker will be 36" deep

\*Order welded for factory assembled Duty locker.

Patriot <b>DUTY - KD</b> Locker Part Number Identification Matrix										
D	K	#	#	#	S	S	*	*	*	*
Product	Type	Width	Depth	Height	LH Side Vent	RH Side Vent	Drawer Base Extension	Door type	Handle Type	Door Vent

Product	Type	# Width	# Depth	# Height	* LH Side Vent	* RH Side Vent	Drawer Base Ext	* Door Type	* Handle Type	* Door Vent
D = Duty	K = KD	18	24	78	S = Solid	S = Solid	N = 9" front extension (See #9 above for details)	S = Single	C = Ultra Cremone Recessed Handle	D = Diamond
				90						E = 12" front extension (See #9 above for details)
		78	90	D = Double			C = Ultra Cremone Recessed Handle	L = Louvers		
		24						90		

**Part Number Examples:**

<b>DK182490SSECL</b>	Duty - KD - 18" wide x 24" deep x 90" high (means 72" lkr with 18" high Drawer Base) - Solid LH Side - Solid RH Side - (E) 12" Front Drawer Extension - Single Door - Ultra Cremone Recessed Handle - Louver Door
<b>DK242478SSNDCS</b>	Duty - KD - 24" wide x 24" deep x 78" high (means 60" lkr with 18" high Drawer Base) - Solid LH Side - Solid RH Side - (N) 9" Front Drawer Extension - Double Door - Ultra Cremone Recessed Handle - Solid Door

Patriot <b>DUTY - Welded</b> Locker Part Number Identification Matrix										
D	W	#	#	#	S	S	*	*	*	*
Product	Type	Width	Depth	Height	LH Side Vent	RH Side Vent	Drawer Base Extension	Door type	Handle Type	Door Vent

Product	Type	# Width	# Depth	# Height	* LH Side Vent	* RH Side Vent	Drawer Base Ext	* Door Type	* Handle Type	* Door Vent
D = Duty	W = Welded	18	24	78	S = Solid	S = Solid	N = 9" front extension (See #9 above for details)	S = Single	C = Ultra Cremone Recessed Handle	D = Diamond
				90						E = 12" front extension (See #9 above for details)
		78	90	D = Double			C = Ultra Cremone Recessed Handle	L = Louvers		
		24						90		

**Part Number Examples:**

<b>DW182478SSNSCL</b>	Duty - Welded - 18" wide x 24" deep x 78" high (means 60" lkr with 18" high Drawer Base) - Solid LH Side - Solid RH Side - (N) 9" Front Drawer Extension - Single Door - Ultra Cremone Recessed Handle - Louver Door
<b>DW242490SSEDCS</b>	Duty - Welded - 24" wide x 24" deep x 90" high (means 72" lkr with 18" high Drawer Base) - Solid LH Side - Solid RH Side - (E) 12" Front Drawer Extension - Double Door - Ultra Cremone Recessed Handle - Solid Door



## Fully Framed Gear & Turnout Lockers

### Configure and Build to Suit

One of the key strengths of the Patriot is its flexibility and modular accessories. Each Patriot accessory is designed for use in any of the four Patriot Locker bodies.

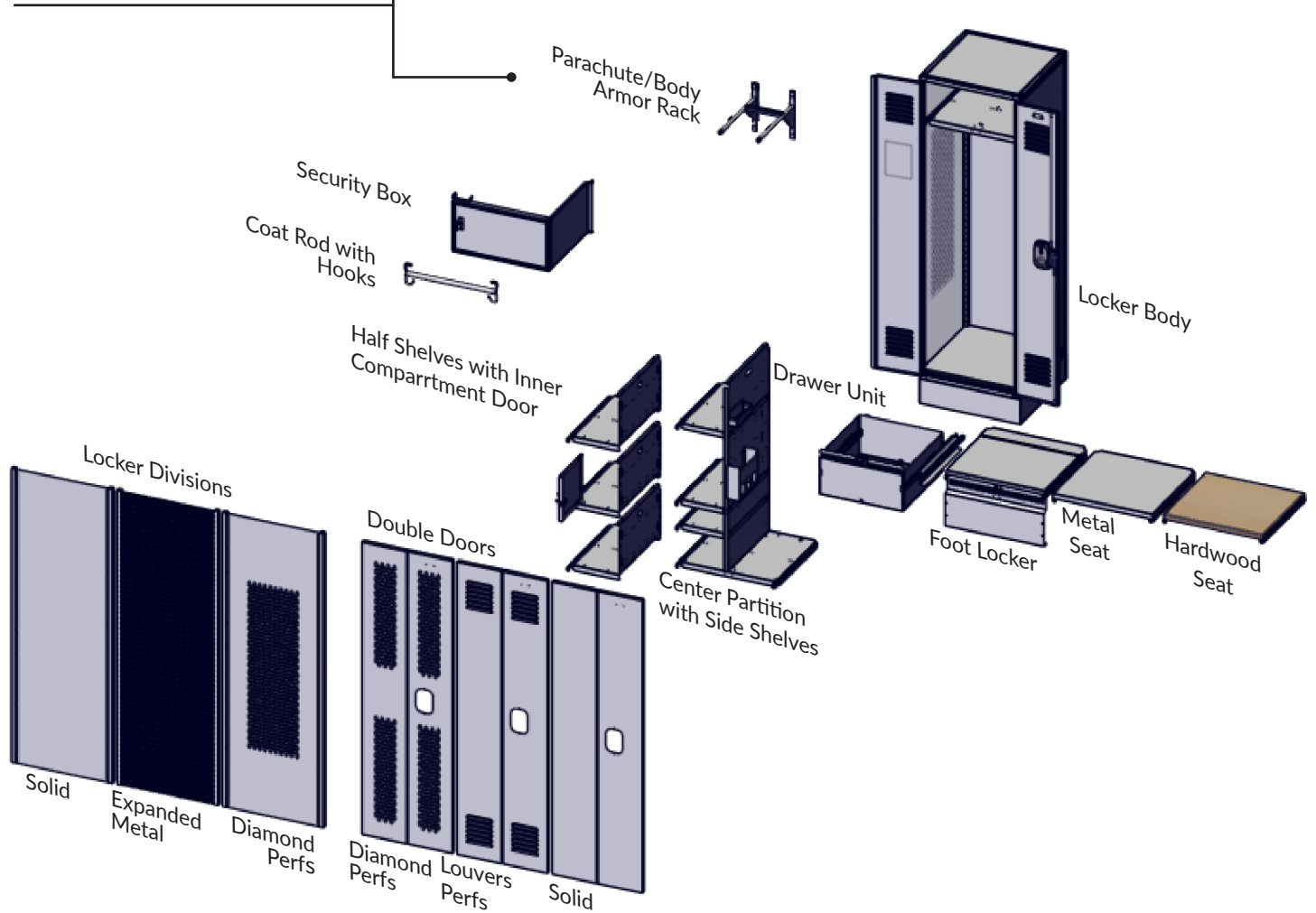

For more information about locker configurations, contact your Penco Representative.

## Locker Accessories (Not for TA-50\* or Stadium\*)

*\*Exception: The 4 or 6-inch high Channel Base is still an option for both TA-50 and Stadium*

The accessories listed here will help you to personalize and organize the lockers to fit your needs.

### Cell Phone/Key Tray:

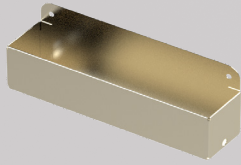

The 8" x 2" x 2" tray is sized for holding and organizing phones, hand radios or keys and can be mounted to center partition or half shelf. If either of these items are not being ordered, you can mount the tray to the side of the locker using 2 Side Rails (see side rails in the accessories)

### Document Sleeve:

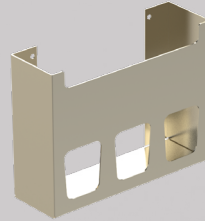

Formed from 16 gauge steel, the document sleeve is available in either a vertical or horizontal configuration for efficient storage of portfolios, note pads or binders.

### Boot Tray:

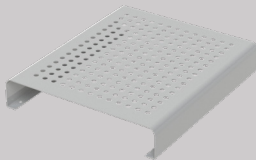

The 12" x 14" boot tray provides air space between soiled or wet footwear and the locker bottom. A series of round hole perforations are used to promote airflow and the tray is kept from marring the locker finish by rubber pads. Not for use on 18" wide lockers with center partition.

### Coat Rod with hooks - Full Length:



Using coat rod hooks mounted to shelf. 18", 24", 30", 36", 42", 48" width sizes correlating to the width of the locker.

### Acrylic Mirror:

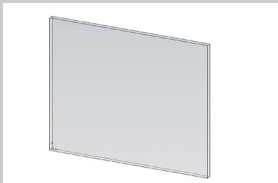

The adhesive-backed mirror resists breakage and can be permanently mounted wherever you need it.

### Coat Rod with hooks - Half Length:



Using coat rod hooks mounted to shelf and used on lockers with center partition or half shelves. 9" for 18" wide locker, 12" for 24" wide locker, 15" for 30" wide locker, 18" for 36" wide locker, 21" for 42" wide locker and 24" for 48" wide locker.

### Security Box:

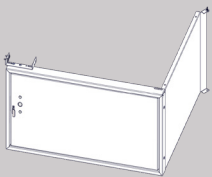

Available in many widths, the security box uses a 18 gauge lockable door, 16 gauge side panel and welded door frame. Uses any standard box locker padlock or built in lock. (lock sold separately)

### Half Shelf:

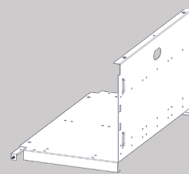

L-shaped half shelf, 16 gauge steel. Attaches securely on one side with a side rail and the flanged partition mounts to shelf or half shelf above.

### Parachute/Body Armor Rack:

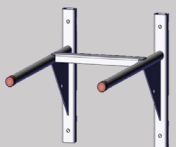

Formed from 3/4 inch diameter, heavy wall steel tube. Reinforced by 14 gauge gussets. Mounted securely to rear of locker. 180-pound capacity. Rack is attached by drilling holes in the locker back and using the nuts, bolts and washers supplied. If ordering welded this will be done at factory, if ordering knockdown must be done on site.

### Side Shelf:

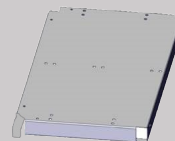

Shelf is only used with center partitions when shelves are needed on either side. 9" for 18" wide locker, 12" for 24" wide locker, 15" for 30" wide locker, 18" for 36" for locker, 21" for 42" wide locker and 24" for 48" wide locker.

### Garment Separator:



Can be used as an alternative to the optional Coat Rod. Mounts to shelf.

### Hook:



Single Prong - mounts to shelf.

## Locker Accessories (Not for TA-50\* or Stadium\*)

*\*Exception: The 4 or 6-inch high Channel Base is still an option for both TA-50 and Stadium*

### Channel Base:



4-inch or 6-inch high. 14 gauge steel formed in a "C" channel that attaches to locker bottom.

### Full Width Shelf:



16 gauge steel. Attaches securely to mounting side rails. Comes with 2 Back Hooks. Order Back Rails when additional shelf support is needed.

### Center Partition:

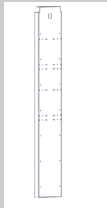

16 gauge steel with a flanged front. Attaches securely to shelf and locker bottom or additional lower shelf. (Not for use with footlocker or seat). Mounting holes for side shelves provided on nominal 6 inch centers.

### Back Rails:

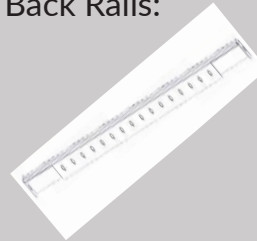

Back Rails are used with full width shelves when extra support is needed. Order one back rail per full width shelf. The size of the back rail correlates with the width of the shelf.

### Bottom 12" High Drawer:

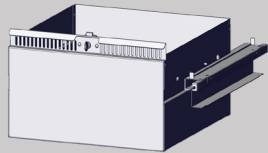

12 inch high and constructed of 16 gauge sheet steel. Provides easy access to files and equipment without taking up valuable space when not in use. Must order shelf for above this drawer. (lock sold separately)

### Intermediate 6" High Drawer:

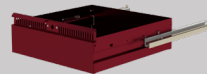

6 inch high and constructed of 16 gauge sheet steel. Can be stacked inside locker. Provides easy access to files and equipment without taking up valuable space when not in use. Must order shelf for above the first drawer. If ordering multiple drawers and each drawer needs to be locked a shelf must be ordered for each drawer. (lock sold separately)

### Wood Seat Option:



Used in place of a footlocker or drawer unit, the 1-1/4" thick solid hardwood bench provides a sturdy seating surface with open storage underneath for stowing larger bags or equipment.

### Metal Seat Option:



Used in place of a footlocker or drawer unit, the 16 gauge metal seat provides a sturdy seating surface with open storage underneath for stowing larger bags or equipment.

### Footlocker:

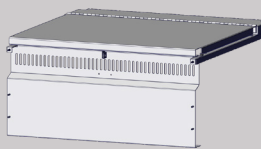

The reinforced lid of the footlocker features a continuous hinge and also serves as a seat. The front panel includes a single point latch with a padlock strike plate for security and vertical ventilation. (lock sold separately)

### Inner Compartment Door:

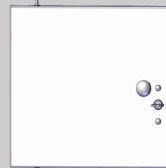

Used only with "L" shaped half shelf. 18 gauge steel. (lock sold separately)

### Additional Accessories:

Standard Penco locker accessories such as vertical fillers, continuous slope hood, locker room benches and recess trim are available for use on Patriot Fully Framed Lockers. See Penco price book for details.

For Patriot Fully Framed Locker Accessories **specifications**, see pages 76-77.

## Locker Accessories (Not for TA-50 or Stadium)

Description	Part #	Size
Center Partition	6FCP1844-K	18 x 44
	6FCP1844-W	18 x 44
	6FCP1857-K	18 x 57
	6FCP1857-W	18 x 57
	6FCP1851-K	18 x 51
	6FCP1851-W	18 x 51
	6FCP2451-K	24 x 51
	6FCP2451-W	24 x 51
	6FCP2444-K	24 x 44
	6FCP2444-W	24 x 44
	6FCP2457-K	24 x 57
6FCP2457-W	24 x 57	
Side Shelf (used with center partitions)	CPHS0918-K	9 x 18
	CPHS0918-W	9 x 18
	CPHS0924-K	9 x 24
	CPHS0924-W	9 x 24
	CPHS1218-K	12 x 18
	CPHS1218-W	12 x 18
	CPHS1224-K	12 x 24
	CPHS1224-W	12 x 24
	CPHS1524-K	15 x 24
	CPHS1524-W	15 x 24
	CPHS1824-K	18 x 24
	CPHS1824-W	18 x 24
	CPHS2124-K	21 x 24
	CPHS2124-W	21 x 24
	CPHS2418-K	24 x 18
CPHS2418-W	24 x 18	
CPHS2424-K	24 x 24	
CPHS2424-W	24 x 24	
Coat Rod Kit - Full Length	6FCR18-K	18
	6FCR18-W	18
	6FCR24-K	24
	6FCR24-W	24
	6FCR30-K	30
	6FCR30-W	30
	6FCR36-K	36
	6FCR36-W	36
	6FCR42-K	42
	6FCR42-W	42
	6FCR48-K	48
6FCR48-W	48	
Coat Rod Kit - Half Length (9" wide, use with 18" wide lkr)	6FCRH09-18K	9
	6FCRH09-18W	9
Coat Rod Kit - Half Length (12" wide, use with 24" wide lkr)	6FCRH12-24K	12
	6FCRH12-24W	12
Coat Rod Kit - Half Length (15" wide, use with 30" wide lkr)	6FCRH15-30K	15
	6FCRH15-30W	15
Coat Rod Kit - Half Length (18" wide, use with 36" wide lkr)	6FCRH18-36K	18
	6FCRH18-36W	18
Coat Rod Kit - Half Length (21" wide, for use with 42" wide lkr)	6FCRH21-42K	21
	6FCRH21-42W	21
Coat Rod Kit - Half Length (24" wide, for with 48" wide lkr)	6FCRH24-48K	24
	6FCRH24-48W	24

Description	Part #	Size
Bottom Drawer - 12" High (bottom of locker only)	DU181812-K	18 x 18 x 12
	DU181812-W	
	DU182412-K	18 x 24 x 12
	DU182412-W	
	DU241812-K	24 x 18 x 12
	DU241812-W	
	DU242412-K	24 x 24 x 12
	DU242412-W	
	DU302412-K	30 x 24 x 12
	DU302412-W	
Bottom Drawer - 12" High (bottom of locker only) actually 18" wide, goes into a 36" w locker	DU362412-K	36 x 24 x 12
	DU362412-W	
Bottom Drawer - 12" High (bottom of locker only) actually 21" wide goes into a 42" w locker	DU422412-K	42 x 24 x 12
	DU422412-W	
Bottom Drawer - 12" High (bottom of locker only) actually 24" wide goes into a 48" w locker	DU482412-K	48 x 24 x 12
	DU482412-W	
Intermediate Drawer - 6" High	DU181806-K	18 x 18 x 6
	DU181806-W	
	DU182406-K	18 x 24 x 6
	DU182406-W	
	DU241806-K	24 x 18 x 6
	DU241806-W	
	DU242406-K	24 x 24 x 6
	DU242406-W	
	DU301806-K	30 x 18 x 6
	DU301806-W	
	DU302406-K	30 x 24 x 6
	DU302406-W	
	DU362406-K	36 x 24 x 6
	DU362406-W	
	DU422406-K	42 x 24 x 6
DU422406-W		
DU482406-K	48 x 24 x 6	
DU482406-W		
Footlocker	FT181812-K	18 x 18 x 12
	FT181812-W	
	FT182412-K	18 x 24 x 12
	FT182412-W	
	FT241812-K	24 x 18 x 12
	FT241812-W	
	FT242412-K	24 x 24 x 12
	FT242412-W	
	FT302412-K	30 x 24 x 12
	FT302412-W	
	FT362412-K	36 x 24 x 12
	FT362412-W	
FT422412-K	42 x 24 x 12	
FT422412-W		
FT482412-K	48 x 24 x 12	
FT482412-W		

## Locker Accessories (Not for TA-50 or Stadium)

Description	Part #	Size
Half Shelf	6FHS0918-K	9 x 18
	6FHS0918-W	
	6FHS0924-K	9 x 24
	6FHS0924-W	
	6FHS1218-K	12 x 18
	6FHS1218-W	
	6FHS1224-K	12 x 24
	6FHS1224-W	
	6FHS1518-K	15 x 18
	6FHS1518-W	
	6FHS1524-K	15 x 24
	6FHS1524-W	
	6FHS1818-K	18 x 18
	6FHS1818-W	
	6FHS1824-K	18 x 24
	6FHS1824-W	
	6FHS2118-K	21 x 18
	6FHS2118-W	
	6FHS2124-K	21 x 24
	6FHS2124-W	
6FHS2418-K	24 x 18	
6FHS2418-W		
6FHS2424-K	24 x 24	
6FHS2424-W		
Inner compartment door (in half shelf only)	6FCMPT09-K	9
	6FCMPT09-W	
	6FCMPT10-K	10
	6FCMPT10-W	
	6FCMPT12-K	12
	6FCMPT12-W	
	6FCMPT15-K	15
	6FCMPT15-W	
	6FCMPT18-K	18
	6FCMPT18-W	
	6FCMPT21-K	21
	6FCMPT21-W	
6FCMPT24-K	24	
6FCMPT24-W		
Inner Compartment Panels: for inside of inner compartment door when your ordering an expended metal division and you want to block the view.	STLCMPT18-K	18" deep
	STLCMPT18-W	
	STLCMPT24-K	24" deep
	STLCMPT24-W	
Metal Seat	FSEAT1818-K	18 x 18
	FSEAT1818-W	
	FSEAT2418-K	24 x 18
	FSEAT2418-W	
	FSEAT2424-K	24 x 24
	FSEAT2424-W	
	FSEAT3024-K	30 x 24
	FSEAT3024-W	
	FSEAT3624-K	36 x 24
	FSEAT3624-W	
	FSEAT4224-K	42 x 24
	FSEAT4224-W	

Description	Part #	Size
Security Box (for top of shelf only)	6FSB918-K	9 x 18
	6FSB918-W	
	6FSB924-K	9 x 24
	6FSB924-W	
Security Box (for top of shelf only) Actually 10.5" wide could put 4 in a 42 wide locker	6FSB1118-K	11 x 18
	6FSB1118-W	
	6FSB1124-K	11 x 24
	6FSB1124-W	
Security Box (for top of shelf only)	6FSB1218-K	12 x 18
	6FSB1218-W	
	6FSB1221-K	12 x 21
	6FSB1221-W	
	6FSB1224-K	12 x 24
	6FSB1224-W	
	6FSB1518-K	15 x 18
	6FSB1518-W	
	6FSB1524-K	15 x 24
	6FSB1524-W	
	6FSB1818-K	18 x 18
	6FSB1818-W	
	6FSB1824-K	18 x 24
	6FSB1824-W	
	6FSB2118-K	21 x 18
	6FSB2118-W	
	6FSB2124-K	21 x 24
	6FSB2124-W	
	6FSB2418-K	24 x 18
	6FSB2418-W	
6FSB2424-K	24 x 24	
6FSB2424-W		
Security Box Panel for inside of inner compartment door when your ordering an expended metal division and you want to block	STL100718-K	18" deep
	STL100718-W	
	STL100724-K	24" deep
	STL100724-W	
Full Width Shelf Comes with 2 Back Hooks	6FSH1818-K	18 x 18
	6FSH1818-W	
	6FSH1824-K	18 x 24
	6FSH1824-W	
	6FSH2418-K	24 x 18
	6FSH2418-W	
	6FSH2421-K	24 x 21
	6FSH2421-W	
	6FSH2424-K	24 x 24
	6FSH2424-W	
	6FSH3024-K	30 x 24
	6FSH3024-W	
6FSH3624-K	36 x 24	
6FSH3624-W		
6FSH4224-K	42 x 24	
6FSH4224-W		
6FSH4824-K	48 x 24	
6FSH4824-W		



## Locker Accessories (Not for TA-50\* or Stadium\*)

*\*Exception: The 4 or 6-inch high Channel Base is still an option for both TA-50 and Stadium*

Description	Part #	Size
Full Width Security Box	SBFW1818-K	18 x 18
	SBFW1818-W	18 x 18
	SBFW1824-K	18 x 24
	SBFW1824-W	18 x 24
	SBFW2418-K	24 x 18
	SBFW2418-W	24 x 18
	SBFW2424-K	24 x 24
	SBFW2424-W	24 x 24

Description	Part #	Size
Garment Separator - Full Width - Replaces Coat Rod	6FGARM-18HK	18 x 2
	6FGARM-18HW	18 x 2
	6FGARM-24HK	24 x 2
	6FGARM-24HW	24 x 2
	6FGARM-30HK	30 x 2
	6FGARM-30HW	30 x 2
	6FGARM-36HK	36 x 2
	6FGARM-36HW	36 x 2
	6FGARM-42HK	42 x 2
6FGARM-42HW	42 x 2	
6FGARM-48HK	48 x 2	
6FGARM-48HW	48 x 2	

Description	Part #	Size
Garment Separator - Half Width	HGARM-09HK	9 x 2
	HGARM-09HW	9 x 2
	HGARM-12HK	12 x 2
	HGARM-12HW	12 x 2
	HGARM-15HK	15 x 2
	HGARM-15HW	15 x 2
	HGARM-18HK	18 x 2
	HGARM-18HW	18 x 2
	HGARM-21HK	21 x 2
	HGARM-21HW	21 x 2
	HGARM-24HK	24 x 2
	HGARM-24HW	24 x 2

Description	Part #	Size
Back Rails - For full width shelves when extra support is needed. Also used for parachute/body armor rack when ordering the rack with partitions and half shelves.	FF101018BK	18"
	FF101018BW	
	FF101024BK	24"
	FF101024BW	
	FF101030K	30"
	FF101030W	
	FF101036K	36"
	FF101036W	
	FF101042K	42"
	FF101042W	
FF101048K	48"	
FF101048W		
Hardwood Bench Seat	BENCH1818HK	18 x 18
	BENCH1818HW	18 x 18
	BENCH1824HK	18 x 24
	BENCH1824HW	18 x 24
	BENCH2418HK	24 x 18
	BENCH2418HW	24 x 18
	BENCH2424HK	24 x 24
	BENCH2424HW	24 x 24
	BENCH3024HK	30 x 24
	BENCH3024HW	30 x 24
	BENCH3624HK	36 x 24
	BENCH3624HW	36 x 24
	BENCH4224HK	42 x 24
BENCH4224HW	42 x 24	
BENCH4824HK	48 x 24	
BENCH4824HW	48 x 24	
Individual Hardwood Seat (for Duty Lockers)	6RQ1242-K	18 x 9.5 x 1.25
	6RQ1242-W	
	6RQ0575-K	24 x 9.5 x 1.25
	6RQ0575-W	
	6RQ11224-K	18 x 12 x 1.25
	6RQ11224-W	
	6RQQ722-K	24 x 12 x 1.25
	6RQQ722-W	
Channel Base - 4 inch high	CBW1818-4K	18 x 18 x 4
	CBW1818-4W	
	CBW1824-4K	18 x 24 x 4
	CBW1824-4W	
	CBW2418-4K	24 x 18 x 4
	CBW2418-4W	
	CBW2421-4K	24 x 21 x 4
	CBW2421-4W	
	CBW2424-4K	24 x 24 x 4
	CBW2424-4W	
	CBW3024-4K	30 x 24 x 4
	CBW3024-4W	
	CBW3624-4K	36 x 24 x 4
	CBW3624-4W	
	CBW4224-4K	42 x 24 x 4
CBW4224-4W		
CBW4824-4K	48 x 24 x 4	
CBW4824-4W		

*\*Exception: The 4 or 6-inch high Channel Base is still an option for both TA-50 and Stadium*

Description	Part #	
<b>D</b>		
Side Rails - Are used if ordering cell phone/key tray and not ordering a center partition or half shelves. The side rails will allow you to attach the tray to the locker side (inside). Two side rails required for each tray.	FF101018SK	18
	FF101010SW	18
	FF101021SK	21
	FF101021SW	21
	FF101024SK	24
	FF101024SW	24

Description	Part #	Size
Channel Base - 6 inch high	CBW1818-6K	18 x 18 x 6
	CBW1818-6W	
	CBW1824-6K	
	CBW1824-6W	18 x 24 x 6
	CBW2418-6K	
	CBW2418-6W	24 x 18 x 6
	CBW2421-6K	
	CBW2421-6W	24 x 21 x 6
	CBW2424-6K	
	CBW2424-6W	24 x 24 x 6
	CBW3024-6K	
	CBW3024-6W	30 x 24 x 6
	CBW3624-6K	
	CBW3624-6W	36 x 24 x 6
	CBW4224-6K	
CBW4224-6W	42 x 24 x 6	
CBW4824-6K		
CBW4824-6W	48 x 24 x 6	
Hooks (single prong - mounts to shelf)	8696	
Cell Phone / Key Tray	60830H	8 x 2
Acrylic Mirror With adhesive back: 1/8" thick Cannot be attached to doors with diamond or visual perforations, mini-louvers and quiet sound-deadening panels.	96370	6 x 8
Parachute/Body Armor Rack Formed from a 3/4-in diameter, heavy wall steel tube. Reinforced by 14-gauge gussets. Mounted securely to rear of locker. 180-pound capacity. Rack is attached by drilling holes in the locker back and using the nuts, bolts and washer supplied. If ordering welded this will be done at factory, if ordering knockdown must be done on site.	6ACXAB33C-K	18
	6ACXAB33C-W	18
Boot Tray Rests on bottom of locker or lower shelf. Fits 24" or wider lockers	6ACXFF09H	14 x 12
Name Card Holder Size shown is card size. NOTE: Add \$2.25 each to punch holes in door for attaching	9446H	2-3/4 x 1-1/4
Document Sleeve - Small (mounts to half shelf or center partition)	6ACXAB32C	9.5 x 3 x 8
Document Sleeve - Large (mounts to half shelf or center partition)	6ACXFF54C	12 x 3 x 8
Leveling Feet Kit - Includes 4 nuts and 4 bolts. NOTE: Can only be used on Fully Framed Lockers. Cannot be used on Duty lockers or be used with Channel Base or Zee Base. We do not offer anything that will cover up the feet if used.	HM0035A	2.5" long

All Patriot Lockers can be outfitted with a number of locking options. While all models are designed to use readily available locker locks, some options requires specific lock types.

A – Gear and Turnout Security Boxes are hinged on the right and can be equipped with any box locker lock including padlocks.

B – The standard Ultra Cremone Recessed Handle on Gear lockers can accept a padlock or built-in lock.

C – Left Hand Inner Compartment Door accepts most built-in dead bolt locks. It does not have a padlock attachment.

D – Right Hand Inner Compartment Door accepts most built-in dead bolt locks. It does not have a padlock attachment.

E – Gear and Turnout Footlockers have a padlock attachment and no provision for built-in locks.

F – Intermediate Drawer for Gear and Turnout are configured to work best with a built-in spring bolt key for ease of use.

G – Bottom Drawers are configured to work best with a built-in spring bolt key for ease of use.

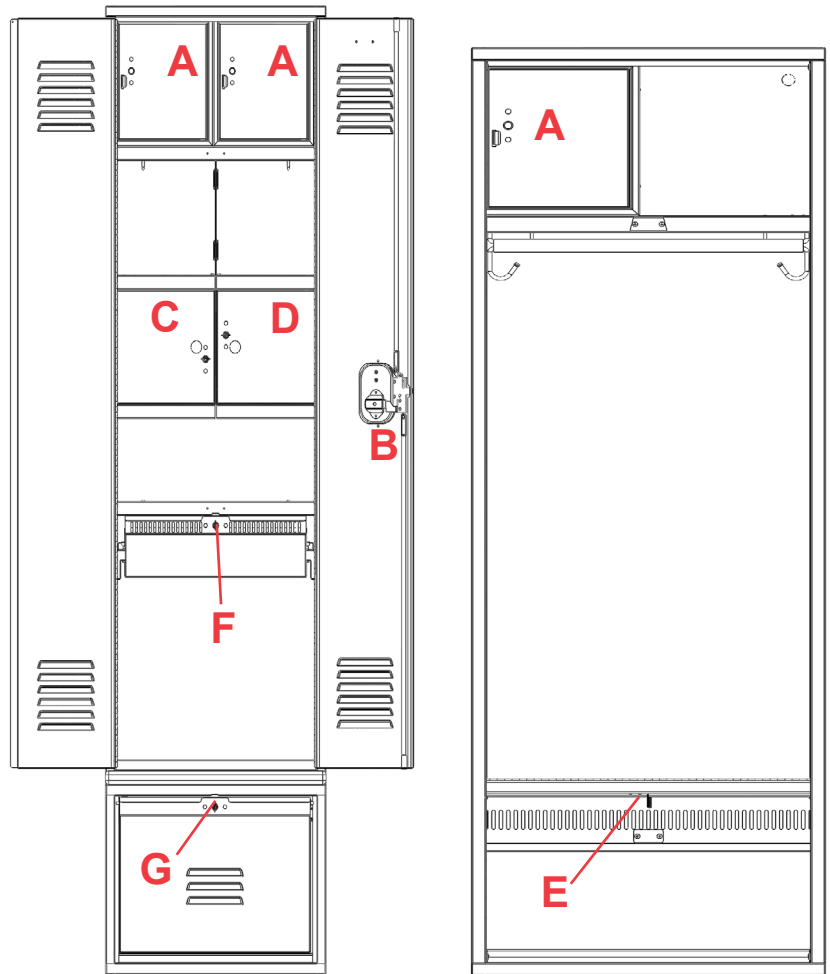

	Padlock	Keyed Spring Bolt	Keyed Dead Bolt	Combination Spring Bolt	Combination Dead Bolt
A	PREFERRED	OK	OK	OK	OK
B	OK	REFER TO LOCK APPLICATION TABLE IN LOCKER PRICE BOOK			
C	NO	PREFERRED (LH)	OK (LH)	OK (LH)	OK (LH)
D	NO	PREFERRED (RH)	OK (RH)	OK (RH)	OK (RH)
E	ONLY	NO	NO	NO	NO
F	NO	PREFERRED	OK	NO	NO
G	NO	PREFERRED	OK	NO	NO

## Accessories / Locker Growth

The illustration below shows several locker groups with frequently ordered accessories.

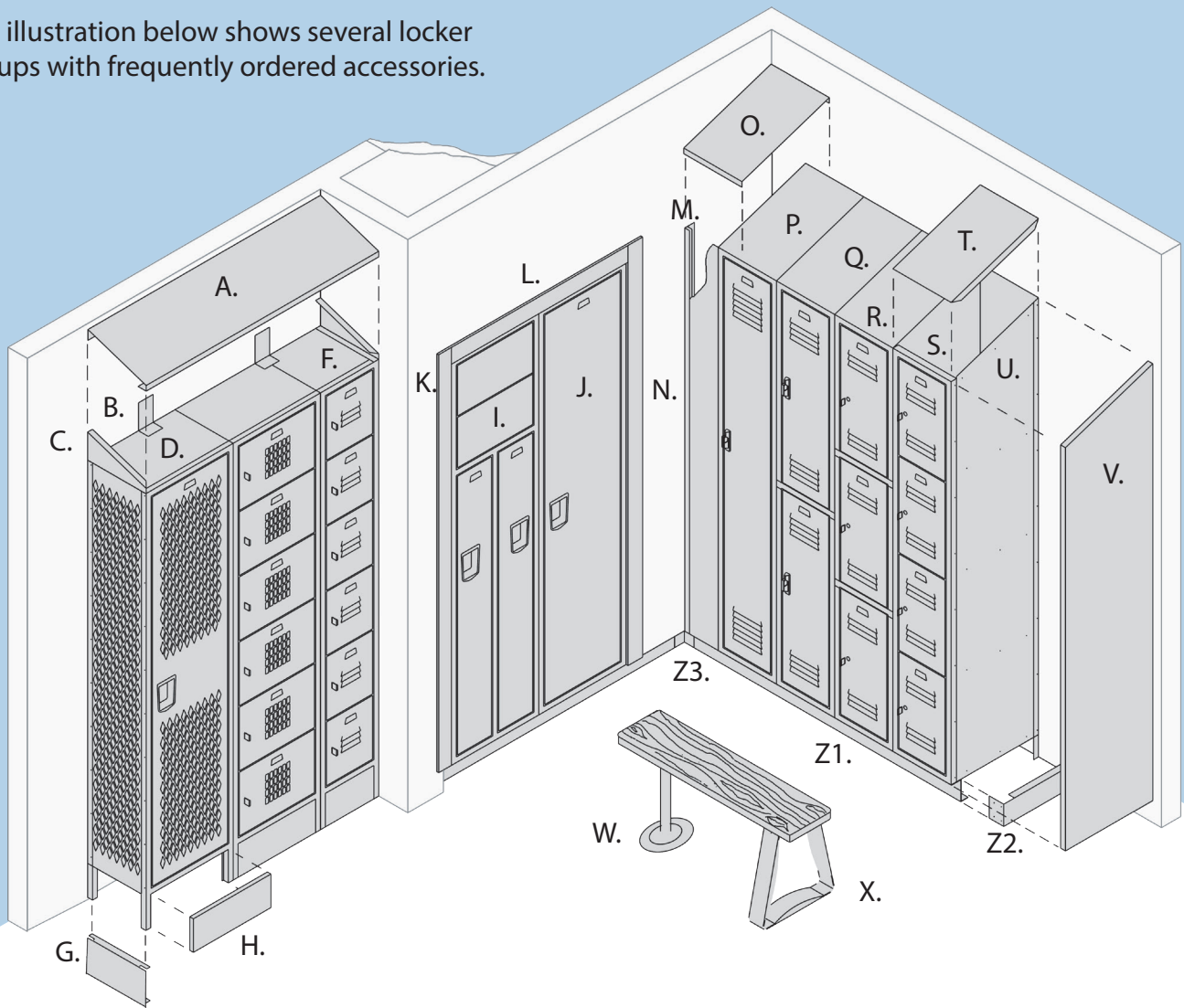

### Key for Illustration

- A. Slope Hood
- B. Universal Rear Hood Support
- C. Slope End for Hood L.H. (Left Hand)
- D. Single Tier Invincible
- E. 6 Tier Box Locker w/Visual Doors
- F. 6 Tier Box Locker w/Std. Louvers
- G. End Base, 6" High
- H. Front Base, 6" High

- I. Two Person Guardian
- J. Single Tier Guardian
- K. Side Recess Trim
- L. Top Recess Trim
- M. Wall Angle Slip Joint
- N. Vertical Filler
- O. Filler, Slope Top
- P. Single Tier Vanguard
- Q. Double Tier Vanguard
- R. Three Tier Vanguard

- S. Four Tier Vanguard
- T. Slope Top, Unit Construction
- U. Slope Top Division (Side)
- V. Boxed Finished End Panel (Right Hand)
- W. Heavy Duty Bench Pedestal
- X. Stainless Steel Bench Pedestal
- Y. Hardwood Bench
- Z1. Zee Base, 4" high
- Z2. Zee End Base/Splice
- Z3. Zee Inside Corner Splice

### Locker "Growth"

When planning an installation of KD lockers, allow an additional 1/16" for each frame. When planning an installation of Welded lockers, allow an additional 1/16" per group. For Angle Iron lockers, contact your Penco representative.

## Slope Top Construction

Slope tops are often used instead of flat tops to prevent the accumulation of dust and debris, and to discourage the use of locker tops as storage areas. There are three different types of slope top construction: Unit Slope Tops, Slope Hoods, and Slope Top Kits. Each is explained below.

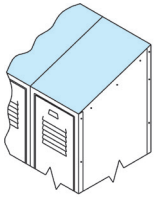

### Unit Slope Tops

Unit Slope Tops cover the width of one locker frame only. Lockers with Unit Slope Tops have sides with mitered top ends with a rise equal to 1/3 of the locker depth, plus longer backs that meet the rear edge of the slope top. Unit slope tops are used in place of the standard flat tops. Order the appropriate locker plus

the proper slope top size. Not for use on Invincible II, Welded, Stadium or Patriot lockers.

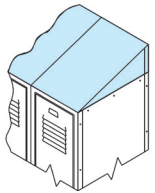

### Slope Top Kits

Designed to convert stock flat top lockers into slope top lockers in groups of 3 wide. Each kit contains 3 tops, 3 backs and 4 ends. Not for use on Invincible II, Welded, Stadium or Patriot lockers.

### Universal Rear Hood Support

Used with 12", 15", 18", 21" and 24" deep hood only.

## Typical Slope Hood Installation

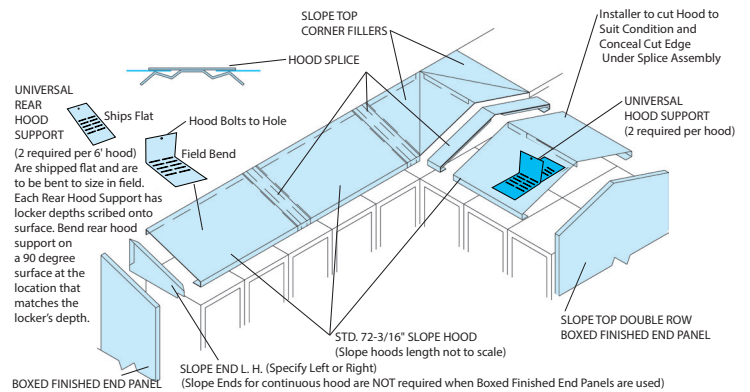

## Continuous Slope Hoods

Continuous slope hoods fit on top of flat top lockers. They can be used on new lockers or on a retrofit basis. All hoods are furnished in 72" lengths and must be cut to length during installation. Hood ends complete the installation and must be ordered separately. Hoods come with 2 rear supports and 1 splice. If extra supports are needed, order separately.

Slope Top Kits - 3 Wide			
Unit Width	Unit Depth	Unit Height	Cat. No.
12"	12"	4"	60230H
	15"	5"	60232H
	18"	6"	60234H
15"	15"	5"	60238H
	18"	6"	60240H
18"	18"	6"	60244H

Continuous Slope Hoods*			
Unit Depth	Unit Height	Unit Width	Cat. No.
12"	5"	72"	66144H
15"	6"	72"	66147H
18"	7"	72"	66150H
21"	8"	72"	66153H
24"	9"	72"	66156H

\*Includes 1 piece of hood, 2 hood supports., and 1 splice.

Continuous Slope Hoods			
Unit Length	Unit Depth	Unit Height	Cat. No.
72"	13"	5.3"	6HDX330H
	16"	6.3"	6HDX124H
	19"	7.3"	6HDX471H

Use only when lockers need to be 1 inch away from wall. Includes 1 piece of hood, 2 hood supports, and 1 splice.- Do NOT use with STANDARD size Slope Ends, Slope Top Corner Fillers, Hip Fillers or Finished End Panels. See special Splices & Hood Supports for these hoods below.

Unit Slope Tops		
Unit Width	Unit Depth	Cat. No.
9"	12"	60332C
	15"	60334C
	18"	60336C
12"	12"	60338C
	15"	60340C
	18"	60342C
15"	21"	60344C
	12"	603450C
	15"	60346C
18"	18"	60348C
	21"	60350C
	18"	60352C
24"	21"	60354C
	24"	60356C
	18"	60364C
24"	21"	60366C
	24"	60368C

Universal Hood Supports	
Unit Height	Cat. No.
5-9	66070

Hood Splice		
Unit Depth	Unit Height	Cat. No.
12"	5"	66168C
15"	6"	66169C
18"	7"	66170C
21"	8"	66171C
24"	9"	66172C

Slope Ends for Hood			
Unit Depth	Unit Height	Left Hand Cat. No.	Right Hand Cat. No.
12"	5"	66158H	66159H
15"	6"	66160H	66161H
18"	7"	66162H	66163H
21"	8"	66164H	66165H
24"	9"	66166H	66167H

Hood Supports	
Unit Height	Cat. No.
5.3"	6HDX480C
6.3"	6HDX481C
7.3"	6HDX474C

Hood Splice	
Unit Depth	Cat. No.
13"	6HDX484C
16"	6HDX127C
19"	6HDX473C

Slope Ends for Hood			
Left/Right	Unit Depth	Unit Height	Cat. No.
LH	13"	5.3"	6HDX642H
RH	13"	5.3"	6HDX643H
LH	16"	6.3"	6HDX125H
RH	16"	6.3"	6HDX126H
LH	19"	7.3"	6HDX694H
RH	19"	7.3"	6HDX695H

## Accessories

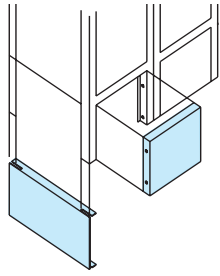

### Individual Closed Bases

Front and end bases are designed to fit between standard Penco 6" legs. They present a clean flush appearance and prevent the accumulation of dust and dirt under the lockers. Front Base snaps in; End Base slips over legs during locker assembly. Only available for knocked down lockers with 6" legs.

### Zee Bases

Zee bases raise lockers without legs 4" off the floor when there is no concrete or wood base. They provide a toe space in the front and a concealed flange for floor anchoring at the rear. A special 4" high rear leg can be ordered to support the back of the locker. (6" high zee bases are also available.)

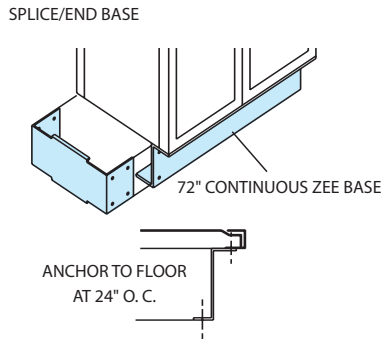

Zee bases are available only in 72" lengths, and may need to be cut to fit at the time of installation. Splices/End Bases are used at ends of rows, and where the front sections join. Not for use on Stadium or Patriot lockers.

### Zee Base Kits

Single row zee bases kits include 1 long front zee base, 1 splice/ends, and 2 rear legs. Double row zee bases include 2 long front zee bases, 2 splice/ends, and 2 rear legs.

Individual Closed Bases - 6" High			
Unit Width	Unit Depth	Cat. No.	
Front Bases			
9"	-	60216C	
12"	-	60217C	
15"	-	60218C	
18"	-	60219C	
24"	-	60220C	
End Bases Single Row			
-	12"	60204C	
-	15"	60205C	
-	18"	60206C	
-	21"	60207C	
-	24"	60208C	
End Bases Double Row			
-	24"	60209C	
-	30"	60210C	
-	36"	60211C	

Zee Bases - 72" Width			
Unit Width	Unit Depth	Unit Height	Cat. No.
Front Zee Bases			
72"	-	4"	66700H
Splice/End Base Single Row			
-	12"	4"	66701H
-	15"	4"	66702H
-	18"	4"	66703H
-	21"	4"	66704H
-	24"	4"	66705H
Splice/End Base Double Row			
-	30"	4"	66707H
-	24"	4"	66706H
-	36"	4"	66708H
Zee Inside Corner Splice			
-	-	4"	66709H
Rear Leg for Zee Base			
-	-	4"	60092C

Zee Bases Kits			
Unit Width	Unit Depth	Unit Height	Cat. No.
Single Row - Includes (1) 72" long Front Zee Base and (1) Splice/Ends and (2) Rear Legs			
72"	12"	4"	6ZBS412KIT
72"	15"	4"	6ZBS415KIT
72"	18"	4"	6ZBS418KIT
72"	21"	4"	6ZBS421KIT
72"	24"	4"	6ZBS424KIT
72"	12"	6"	6ZBS612KIT
72"	15"	6"	6ZBS615KIT
72"	18"	6"	6ZBS618KIT
72"	21"	6"	6ZBS621KIT
72"	24"	6"	6ZBS624KIT
Double Row - Includes (1) 72" long Front Zee Base and 1) Splice/Ends and (2) Rear Legs			
72"	24"	4"	6ZBD424KIT
72"	30"	4"	6ZBD430KIT
72"	36"	4"	6ZBD436KIT
72"	24"	6"	6ZBD624KIT
72"	30"	6"	6ZBD630KIT
72"	36"	6"	6ZBD636KIT

## Fillers

Penco provides standard fillers to adapt lockers to a wide range of field conditions and provide a professional, finished appearance. Fillers can be used to cover columns, pipes or other obstacles in a row of lockers, or fill the gap between the lockers and a wall.

**Vertical Fillers.** These come in three widths and are designed to be used in conjunction with Wall Angle Slip Joints for a solid fit and smooth finish. The slip joint conceals any raw edges caused by field cutting. Additional sizes are available. (Illustration at right.)

**Top Fillers.** Top Fillers cover gaps between tops of lockers. They overlap the locker tops and can be field cut to allow for pipes, etc. There are separate designs for flat top and slope top, and in-line vs. corner applications (illustration below).

Slope Top Fillers are not to be used with slope hoods. Slope Top Corner Fillers can be used with Slope Hoods or Unit Slope Tops

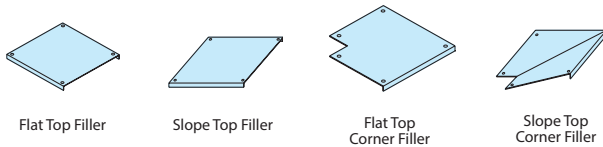
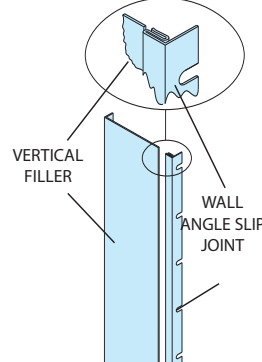

## Vertical Filler Kits

Vertical filler kits include 1 filler and 1 wall angle.

## Slope Top Corner Filler Kits

For use with continuous hood ONLY. Includes 1 slope top corner filler and 2 splices.

Fillers for Welded GEN2 Lockers with 4" Channel Base - Includes (1) filler and (1) wall angle		
Unit Width	Unit Height	Cat. No.
Welded GEN2 Filler Kits		
5"	64"	661123-KIT
	76"	661124-KIT
9"	64"	661125-KIT
	76"	661126-KIT
12"	64"	661127-KIT
	76"	661128-KIT

Vertical Fillers		
Unit Width	Unit Height	Cat. No.
Verticle Angles		
5"	36-1/2"	66190C
	48-1/2"	66191C
	60"	66112C
	66"	661222C
9"	72"	66115C
	36-1/2"	66192C
	48-1/2"	66193C
	60"	66114C
12"	66"	66124C
	72"	66117C
	78"	66127C
	36-1/2"	66194C
12"	48-1/2"	66195C
	60"	66113C
	66"	661221C
	72"	661141C
	78"	66116C
	90"	661173C
	90"	661212C
Wall Angle Slip Joints		
-	36-1/2"	66200C
-	48-1/2"	66201C
-	60"	66118C
-	66"	66120C
-	72"	66119C
-	78"	66121C
-	90"	661212C

Top Fillers		
Unit Width	Unit Depth	Cat. No.
Flat Top Fillers		
15"	12"	661321C
	15"	661322C
	18"	661323C
Slope Top Fillers		
15"	12"	661371C
	15"	661372C
	18"	661373C
Flat Top Corner Fillers		
12"	12"	66138C
15"	15"	66139C
18"	18"	66140C

Vertical Filler Kits - Includes 1 filler and 1 wall angle		
Unit Width	Unit Height	Cat. No.
20ga Kits		
5"	36-1/2"	66190-KIT
	48-1/2"	66191-KIT
	60"	66112-KIT
	66"	661222-KIT
	72"	66115-KIT
9"	36-1/2"	66192-KIT
	48-1/2"	66193-KIT
	60"	66114-KIT
	66"	66124-KIT
	72"	66117-KIT
12"	78"	66127-KIT
	36-1/2"	66194-KIT
	48-1/2"	66195-KIT
	60"	66113-KIT
	66"	66221-KIT
	72"	661141-KIT
	78"	66116-KIT
90"	661173-KIT	

Slope Top Corner Fillers - For use with Continuous Hood ONLY		
Unit Width	Unit Height	Cat. No.
Slope Top Corner Fillers		
12"	12"	66092C
13"	13"	66093C
15"	15"	66094C
16"	16"	66095C
18"	18"	66096C
19"	19"	66097C
21"	21"	66098C
24"	24"	66099C

Slope Top Corner Filler Kits - For use with Continuous Hood ONLY. Includes 1 slope top corner filler and 2 splices		
Unit Width	Unit Height	Cat. No.
20ga Kits		
12"	12"	66100C
13"	13"	6HDX331C
15"	15"	66101C
16"	16"	6HDX691C
18"	18"	66102C
19"	19"	6STX071C
21"	21"	66103C
24"	24"	66104C

## Accessories



### Extra Steel Locker Shelves

Extra locker shelves can be added to K.D. lockers to meet special user requirements. Most lockers have extra holes already punched into side panels for mounting. In some cases shelf mounting holes may need to be drilled. Please consult your Penco sales representative for shelf mounting requirements.

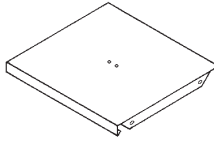

Pictured: Single Tier Vanguard Locker with 5 shelves.



### Recess Trim

Recess trim is 3" wide and bridges the gap between lockers and wall and/or soffits when the lockers are recessed into a wall. Side trim for left hand (LH) and right hand sides (RH) are different. Side Trim comes in three types: 1) for use with lockers with no legs, 2) with 6" legs and 3) for use with Bottom Recess Trim.

The soffit is to be constructed by general contractor. Face of soffit must be flush with face of locker. There should be 1" between top of locker and bottom of soffit. The recessed trim extends 3/8" from face of soffit.

Recess Trim - 3" High		
Unit Width	Unit Depth	Cat. No.
Top Trim		
74"	-	60456H
Splice		
2"	-	66105C
Outside Corner Splice		
2"	2"	66108C
Bottom Trim		
72"	-	60458C

Recess Side Trim - 3" Wide	
Unit Height	Cat. No.
Side Trim - LH (Use with lockers that have No Legs)	
63"	60465C
75"	60469C
87"	60473C
Side Trim - RH (Use with lockers that have No Legs)	
63"	60466C
75"	60470C
87"	60474C
Side Trim - LH (Use with Top Trim & 6" Legs)	
69"	60467C
81"	60471C
93"	60475C
Side Trim - RH (Use with Top Trim & 6" Legs)	
69"	60468C
81"	60472C
93"	60476C
Side Trim - LH (Use with Top & Bottom Trim)	
66"	60477C
78"	60479C
90"	60481C
Side Trim - RH (Use with Top & Bottom Trim)	
66"	60478C
78"	60480C
90"	60482C

#### Front View of Locker with Recessed Trim

Lockers must be anchored to base (base and wood to be completed by General Contractor)

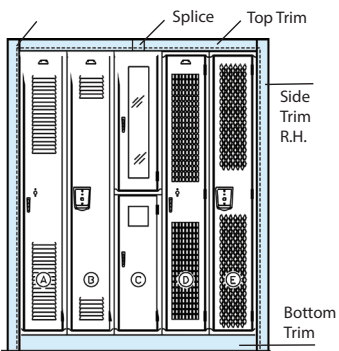

- A. Vanguard with recessed handle
- B. Fire extinguisher/waste bin door
- C. Vanguard w/optional visual perf
- D. Invincible II

#### Example of Side View of Base and Anchor

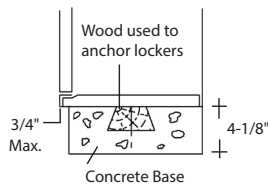

#### Top View of 3" Vertical Trim R.H.

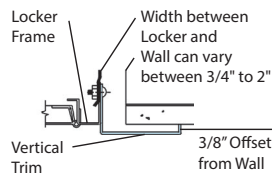

#### Side View of Top Recessed Trim

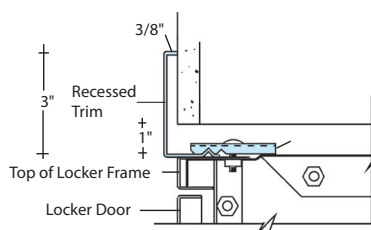

#### Top View of a Recessed Locker Grouping

Recessed Opening = Length of Locker Group (w/growth) + 3"

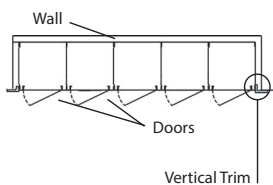



# Steel Lockers

## Accessories

### Locking System Options

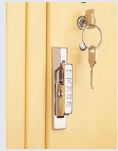

#### Built-in Key Locks

Available in flat key or grooved key models. Dead bolt and spring bolt construction. Reversible for LH & RH applications.



#### Built-in Combination Locks

Available with five combination changes for security year to year. Master key controlled. Stainless steel escutcheon plate. Use dead bolt models for all but box lockers, which use spring bolt. Available in LH & RH.

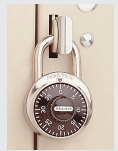

#### Combination Padlocks

Available with and without master keying. 3 number dialing. Rust resistant. Fits box lockers, Die-Cast Handles, recessed handles, cremone handles and basket racks.

Note: For proper fit and security, padlock shackle must have a diameter of 9/32" or 5/16" and a distance of .75" to .81" between the top of the case and the underside of the shackle when in the locked position.

### ADA Compliant Locks



#### Key Lock Model No. 6RQ1478

Just insert key (turning not required) and lift latch pull to open door.

#### Key Lock Model No. 9676A

Has an oversized keyhead to facilitate turning.

### Benches and Pedestals

A natural accessory for any locker room. Benches add permanent comfort and order to the floor plan arrangement.

Penco offers a choice of bench pedestal styles. Order two pedestals for standard benches 96" long or less; order three pedestals for benches over 96" long. The seat portion of ADA benches require a minimum of 4 pedestals, placed as shown in the photo of the Bench Bracket.

### Hardwood Bench Tops

Exceptionally strong wood locker room benches finished with clear lacquer.

For ADA (Americans With Disabilities Act) compliant benches, use 16" or 18" deep bench backs and 20" or 24" deep seats plus Bench Brackets to support the backs. Order Pedestals separately.

Bench Tops			
Unit Width	Unit Depth	Unit Thickness	Cat. No.
Standard Bench Tops			
36"	9-1/2"	1-1/4"	9611
48"	9-1/2"	1-1/4"	9600
48"	12"	1-1/4"	9622
60"	9-1/2"	1-1/4"	9601
72"	9-1/2"	1-1/4"	9602
84"	9-1/2"	1-1/4"	9603
96"	9-1/2"	1-1/4"	9604
108"	9-1/2"	1-1/4"	9605
120"	9-1/2"	1-1/4"	9606
132"	9-1/2"	1-1/4"	9607
144"	9-1/2"	1-1/4"	9608
ADA Compliant Benches			
42"	16"	1-1/4"	9634
48"	16"	1-1/4"	9635
42"	18"	1-1/4"	9625
48"	18"	1-1/4"	9628
42"	20"	1-1/4"	9636
48"	20"	1-1/4"	9632
42"	24"	1-1/4"	9624
48"	24"	1-1/4"	9623

### A. Heavy Duty Bench Pedestal

16-1/4" high pedestal consists of a heavy duty steel tube welded to top and bottom flanges. Hardware for fastening to the bench only is included. Pedestal must be anchored to the floor. Order two or more per standard bench; four or more for ADA compliant bench. Available for quick shipment in 028 Gray and 073 Champagne. Available on production schedules in all standard colors. Cat. No. 60822H

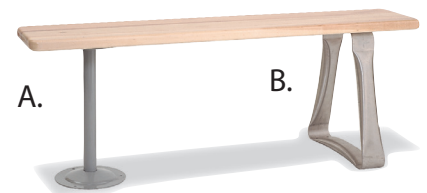

### B. Stainless Steel Free Standing Pedestal

This pedestal has a 14" wide base which allows for moveable free standing use. Holes in the bottom are provided for optional floor anchoring or for attachment of non-skid bumpers (see below). Hardware is supplied for fastening to the bench top. Height is 16-1/4". Cat. No. 60827H each.

### Non-Skid Pedestal Kit for Stainless Steel Pedestal

Rubber non-skid bumpers to prevent damage to floors. Consists of set of 4 non marking rubber feet and fastening hardware. Order 1 kit per pedestal. Cat. No. 68420

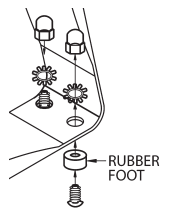

### Bench Bracket for Back of ADA Benches

For attaching 16" or 18" backrest to 20" or 24" deep benches for ADA use. Sturdy steel construction. Order a minimum of 2 per back. Size is 19" x 19" x 2". Hardware included. Cat. No. 6ACXHP61H

### Mirror

Made of acrylic plastic that will not break in normal usage. Mirror has an adhesive backing for easy installation. Size is 6" wide x 8" high. Cat. No. 96370

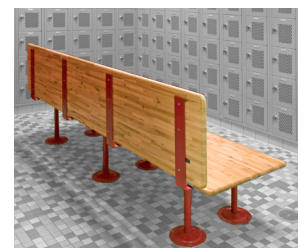

## Special Purpose Lockers



### Fire Extinguisher Door and Waste Bin door

Lockers can be designated to contain a fire extinguisher door and/or a waste receptacle. The opening on the fire extinguisher door is glazed with wire-reinforced glass.

Waste bin doors have a cut-out with an internal flap and a top spring-loaded hinge to keep the opening closed when not being used. There is a small metal chute inside the door to direct the waste to a waste container (container is

not included).

These items are typically ordered in 12" or 15" wide 1 and 2 tier lockers. If recessed handles are used, the width must be a minimum of 15" wide. Locks should not be used on fire extinguisher doors or waste bin doors.

### Mirror

Made of acrylic plastic that will not break in normal usage. Mirror has an adhesive backing for easy installation. Size is 6" wide x 8" high. Cat. No. 96370



### Food Industry Lockers

For ease of cleaning beneath lockers. Leg extensions increase the 6" height to 16". Order as piece parts or in a kit specially designed for 18" deep lockers. Kits include supports for a hardwood bench (order bench separately). Lockers must have standard 6" legs. Not for use with Welded, Stadium or Patriot lockers.

Food Industry Locker Conversion			
Unit Width	Unit Depth	Unit Height	Cat. No.
Kits, 18" Depth			
1 Wide	-	16"	64001
3 Wide	-	16"	64003
Rear Leg			
-	-	16"	65540H
Bench Support			
-	18"	-	65541H
End Front Leg			
-	-	16"	65542H
Intermediate Front Leg			
-	-	16"	65543H

# Shoulder Pads & Helmet Racks

Trouble with damp shoulder pads and helmets?  
Penco has the solution!

Order locker separately.  
Lockers shown to the right are only  
to show how the rack mounts on top.



Easy to mount



Drill 6 holes to existing  
locker tops



Reduces germs and odors by keeping shoulder  
pads and helmets dry



Part Number - 6ACXIA145H

Weight - 4 pounds each



## Basket Racks

Cat. #	Unit Width	Unit Depth	Unit Height	Per	Wt	Pkg
<b>9" Wide Baskets, 4 Baskets Wide X 7 Baskets High = 28</b>						
65910	40"	13"	70"	Ea.	113.0	LPP
<b>9" Wide Baskets, 4 Baskets Wide X 8 Baskets High = 32</b>						
65930	40"	13"	79"	Ea.	129.0	LPP
<b>12" Wide Baskets, 3 Baskets Wide x 7 Baskets High = 21</b>						
65800	40"	13"	70"	Ea.	110.0	LPP
<b>12" Wide Baskets, 3 Baskets Wide x 8 Baskets High = 24</b>						
65830	40"	13"	79"	Ea.	123.0	LPP

## Caster Support

Order 4 per set of casters

Cat. #	NET PRICE	Per	Wt	Pkg
65840C	5.05	Ea.	2.0	LPP

## Caster Set for Basket Racks

For attachment to legs of basket racks. Priced as set of 4 swivel type casters. For double-faced racks, use 1 set of 4. Adds 5-1/5" to height of rack. Order 4 "caster supports" #65840C separately is required.

Cat. #	Unit Width	Unit Depth	Per	Wt	Pkg
9650H	3"	3 inch Dia.	Set	5.0	LPP

## All Wire Baskets

Number plates for baskets must be order separately. Sequence must be specified

Cat. #	Unit Width	Unit Depth	Unit Height	Per	Wt	Pkg
9621	9"	13"	8"	Ea.	2.0	LPP
9620	12"	13"	8"	Ea.	2.0	LPP

## Vanguard™ Lockers (KD)

### PART 1 – GENERAL

#### 1.01 SECTION INCLUDES

Standard Knocked Down Lockers

#### 1.02 REFERENCES

ADAAG - Americans with Disabilities Act, Accessibility Guidelines.

#### 1.03 SUBMITTALS

Submit under provisions of Section 01 33 00. Shop Drawings shall show dimensioned plans, elevations, and sections.

#### 1.04 DELIVERY, STORAGE AND HANDLING

Store products in manufacturer's unopened packaging until ready for installation to protect the locker finish and adjacent surfaces from damage.

### PART 2 – PRODUCTS

#### 2.01 MANUFACTURER

Penco Products, Inc. or approved equal based upon ability to provide product compliant with specifications of the product selected. Provide only metal lockers fabricated in the United States by a single domestic manufacturer.

#### 2.02 MATERIALS

**Steel:** All Penco standard lockers are constructed using prime grade mild cold-rolled sheet steel free from surface imperfection meeting ASTM A1008 and capable of taking a high-grade enamel powder coat finish. Alternate material: Sheet steel components shall be fabricated using zinc-coated steel meeting ASTM A879 and finished in the same manner. Forged steel coat hooks with balled ends and truss fin head bolts and hex nuts will be zinc coated and supplied for all lockers unless otherwise indicated.

**Greenguard:** Lockers shall be GREENGUARD Gold Certified by UL Environment through the GREENGUARD Certification Program.

#### 2.03 STANDARD LOCKERS

**Acceptable Product:** Penco Vanguard, knock-down lockers. Tops, Bottoms, Backs, Sides, and Shelves fabricated from 24 gauge sheet steel. Locker doors measuring less than 12 inches wide are 18 gauge steel. All others are fabricated from 16 gauge sheet steel. 6 inch legs are standard and can be deleted as a no cost option.

**Door Frame:** Channel shape, not less than 16 gauge steel. Provide vertical door frame members with additional 3/8 inch (9.5 mm) flange as a continuous door strike. Intermediate cross frame members are standard on double and triple tier lockers.

**Multi-Point Latch Doors:** One piece sheet steel with full channel formation of adequate depth to fully conceal lock bar on lock side, channel formation on hinge side, right angle formations across top and bottom, with holes for attaching number plates. Doors

over 15 inches wide by 60 inches or 72 inches high will include a 3 inch wide 20 gauge full height reinforcing pan welded to inside face of door at 6 inch centers.

**Box Lockers:** One piece sheet steel with channel formations on lock and hinge sides, right angle flanges on top and bottom; pre-punch doors for padlock latch and friction catch and built-in combination and key locks.

**Ventilation:** Provide louvered doors in manufacturer's standard louver pattern.

**Hinges:** Two inch high, double spun, full loop, tight pin, projection welded to door frame and securely fastened to the door with steel rivets. Provide three 2 inch five-knuckle hinges on doors over 48 inches high and two 2 inch high five-knuckle hinges on all other doors.

#### 2.04 DOOR HANDLES AND LATCHING Two Person and Duplex Lockers, 1, 2 and 3 Tier featuring multi-point latching:

**Recessed Handle:** Classic III Multi-point latching with recessed handle activated by a 14 gauge finger-lift control handle in a 22 gauge drawn and brushed stainless steel pocket fastened to the door with two tabs and a positive tamper-resistant decorative fastener. Depth shall be sufficient to prevent a standard combination padlock, built-in combination lock, or key lock from protruding beyond door face. Nylon lift trigger accommodates use of 9/32 inch padlock.

**Die-Cast Handle:** Chrome-plated zinc alloy die-cast case and handle attached to latch bar concealed inside door and tamperproof. Pulling handle out shall move latch bar up and open door in one motion and providing for use of 9/32 inch diameter padlock, integral with handle and located so that extension of handle forms padlock strike. Doors over 48 inches high shall use glass-filled nylon clips to engage the door frame and hold the door shut at three points. All other doors engage at two points.

**Locking Device:** Positive, automatic type, whereby locker may be locked when open, then closed without unlocking. Firmly secure one rubber silencer in frame at each latch hook.

**Box Lockers (3 to 6 Tier):** Punch doors for use with padlocks or built-in locks and configure doors for use with padlocks with an 18 gauge combination door pull, staple, and lock hole cover plate with integral friction catch.

#### 2.05 INTERIOR EQUIPMENT

**ADA-Compliant Lockers (Recessed Handles with Multi-Point Latch):** Single Tier: Hat shelf 48 inches from locker bottom or lower as required by base condition. Double Tier: Only bottom opening, a shelf placed 15 inches off the floor or lower as required by base condition.

#### 2.07 FABRICATION

Fabrication shall be on the unit principle, each locker with individual door and frame, individual top, bottom, back, and shelves, with common intermediate divisions separating compartments.

**Finish:** High quality powder coat paint finish applied in strict adherence to paint manufacturer's specifications to provide optimum appearance and performance. Finishes releasing VOCs are not acceptable. Standard coating thickness is 1 mil dry film thickness minimum. Powder Coat Plus option increases thickness to 2 mil minimum. Colors as selected from manufacturer's standard colors.

Alternative finishes: Custom color match, Anti Graffiti, antimicrobial, TGIC and high performance finishes are available.

### PART 3 – EXECUTION

#### 3.01 EXAMINATION

Do not begin installation until substrates and bases have been properly prepared. If substrate and bases are the responsibility of another installer, notify Architect of unsatisfactory preparation before proceeding.

#### 3.02 INSTALLATION

Install metal lockers and accessories at locations shown in accordance with manufacturer's instructions. Install lockers plumb, level, and square. Anchor lockers to floor and wall at intervals recommended by the manufacturer. Bolt adjoining locker units together to provide rigid installation.

#### 3.03 ADJUSTING

Adjust doors and latches to operate without binding. Verify that latches are operating satisfactorily. Adjust built-in locks to prevent binding of dial or key and ensure smooth operation prior to substantial completion.

Touch-up with factory-supplied paint and repair or replace damaged products before substantial completion.

#### 3.04 PROTECTION

Protect installed products until completion of project.

Full MasterFormat Specifications can be found on [pencoproducts.com](http://pencoproducts.com).

## Guardian™ Lockers (KD)

### PART 1 – GENERAL

#### 1.01 SECTION INCLUDES

Standard Knocked Down Lockers

#### 1.02 REFERENCES

ADAAG - Americans with Disabilities Act, Accessibility Guidelines.

#### 1.03 SUBMITTALS

Submit under provisions of Section 01 33 00. Shop Drawings shall show dimensioned plans, elevations, and sections.

#### 1.04 DELIVERY, STORAGE, AND HANDLING

Store products in manufacturer's unopened packaging until ready for installation to protect the locker finish and adjacent surfaces from damage.

### PART 2 – PRODUCTS

#### 2.01 MANUFACTURER

Penco Products, Inc. or approved equal based upon ability to provide product compliant with specifications of the product selected. Provide only metal lockers fabricated in the United States by a single domestic manufacturer.

#### 2.02 MATERIALS

**Steel:** All Penco standard lockers are constructed using prime grade mild cold-rolled sheet steel free from surface imperfection meeting ASTM A1008 and capable of taking a high-grade enamel powder coat finish. Alternate material: Sheet steel components shall be fabricated using zinc-coated steel meeting ASTM A879 and finished in the same manner. Forged steel coat hooks with balled ends and truss fin head bolts and hex nuts will be zinc coated and supplied for all lockers unless otherwise indicated.

**Greenguard:** Lockers shall be GREENGUARD Gold Certified by UL Environment through the GREENGUARD Certification Program.

#### 2.03 STANDARD LOCKERS

**Acceptable Product:** Penco Guardian, knock-down lockers. Tops, Bottoms, Backs, Sides, and Shelves fabricated from 24 gauge sheet steel. Locker doors measuring less than 12 inches wide are 18 gauge steel. All others are fabricated from 16 gauge sheet steel. 6 inch legs are standard and can be deleted as a no cost option.

**Door Frame:** Channel shape, not less than 16 gauge steel. Provide vertical door frame members with additional 3/8 inch (9.5 mm) flange as a continuous door strike. Intermediate cross frame members are standard on double and triple tier lockers.

**Multi-Point Latch Doors:** One piece sheet steel with full channel formation of adequate depth to fully conceal lock bar on lock side,

channel formation on hinge side, right angle formations across top and bottom, with holes for attaching number plates. Doors over 15 inches wide by 60 inches or 72 inches high will include a 3 inch wide 20 gauge full height reinforcing pan welded to inside face of door at 6 inch centers.

**Ventilation:** Flush door front with no exposed louvers and air flow slots located in top and bottom flanges of door.

**Hinges:** Two inch high, double spun, full loop, tight pin, projection welded to door frame and securely fastened to the door with steel rivets. Provide three 2 inch five-knuckle hinges on doors over 48 inches high and two 2 inch high five-knuckle hinges on all other doors.

#### 2.04 DOOR HANDLES AND LATCHING

**Two Person and Duplex Lockers, 1, 2 and 3 Tier Featuring Multi-point Latching:** Classic III Multi-point latching with recessed handle activated by a 14 gauge finger-lift control handle in a 22 gauge drawn and brushed stainless steel pocket fastened to the door with two tabs and a positive tamper-resistant decorative fastener. Depth shall be sufficient to prevent a standard combination padlock, built-in combination lock, or key lock from protruding beyond door face. Nylon lift trigger accommodates use of 9/32 inch padlock. Doors over 48 inches high shall use glass-filled nylon clips to engage the door frame and hold the door shut at three points. All other doors engage at two points.

**Locking Device:** Positive, automatic type, whereby locker may be locked when open, then closed without unlocking. Firmly secure one rubber silencer in frame at each latch hook.

#### 2.05 INTERIOR EQUIPMENT

**ADA-Compliant Lockers:** Single Tier: Hat shelf 48 inches from locker bottom or lower as required by base condition. Double Tier: Only bottom opening, a shelf placed 15 inches off the floor or lower as required by base condition.

#### 2.06 FABRICATION

Fabrication shall be on the unit principle, each locker with individual door and frame, individual top, bottom, back, and shelves, with common intermediate divisions separating compartments.

**Finish:** High quality powder coat paint finish applied in strict adherence to paint manufacturer's specifications to provide optimum appearance and performance. Finishes releasing VOCs are not acceptable. Standard coating thickness is 1 mil dry film thickness minimum. Powder Coat Plus option increases thickness to 2 mil minimum. Colors as selected from manufacturer's standard colors.

Alternative Finishes: Custom color match, Anti Graffiti, antimicrobial, TGIC and high performance finishes are available.

### PART 3 – EXECUTION

#### 3.01 EXAMINATION

Do not begin installation until substrates and bases have been properly prepared. If substrate and bases are the responsibility of another installer, notify Architect of unsatisfactory preparation before proceeding.

#### 3.02 INSTALLATION

Install metal lockers and accessories at locations shown in accordance with manufacturer's instructions. Install lockers plumb, level, and square. Anchor lockers to floor and wall at intervals recommended by the manufacturer. Bolt adjoining locker units together to provide rigid installation.

#### 3.03 ADJUSTING

Adjust doors and latches to operate without binding. Verify that latches are operating satisfactorily. Adjust built-in locks to prevent binding of dial or key and ensure smooth operation prior to substantial completion.

Touch-up with factory-supplied paint and repair or replace damaged products before substantial completion.

#### 3.04 PROTECTION

Protect installed products until completion of project.

### DOOR OPTIONS

**Guardian Medallion:** Doors will include sound-deadening material enclosed in a 3 inch wide 22 gauge partial height pan welded to inside face of door.

**Guardian Plus:** Locker doors are fabricated from 14 gauge sheet steel.

Penco Products, Inc. reserves the right to vary specifications consistent with a policy of continuous product improvement.

Full MasterFormat Specifications can be found on [pencoproducts.com](http://pencoproducts.com).

## Guardian Defiant™ II Single Point Latch (SPL)

### PART 1 – GENERAL

#### 1.01 SECTION INCLUDES

Standard Knocked Down Lockers

#### 1.02 REFERENCES

ADAAG - Americans with Disabilities Act, Accessibility Guidelines.

#### 1.03 SUBMITTALS

Submit under provisions of Section 01 33 00. Shop Drawings shall show dimensioned plans, elevations, and sections.

#### 1.04 DELIVERY, STORAGE, AND HANDLING

Store products in manufacturer's unopened packaging until ready for installation to protect the locker finish and adjacent surfaces from damage.

### PART 2 – PRODUCTS

#### 2.01 MANUFACTURER

Penco Products, Inc. or approved equal based upon ability to provide product compliant with specifications of the product selected. Provide only metal lockers fabricated in the United States by a single domestic manufacturer.

Lockers shall be GREENGUARD Gold Certified by UL Environment through the GREENGUARD Certification Program.

#### 2.02 MATERIALS

**Steel:** All Penco standard lockers are constructed using prime grade steel free from surface imperfection suitable for powder coating. Alternate material: Prime grade steel shall be fabricated using galvanized steel and finished in the same manner. Forged steel coat hooks with balled ends and truss fin head bolts and hex nuts will be zinc coated and supplied for all lockers unless otherwise indicated.

#### 2.03 STANDARD LOCKERS

**Acceptable Product:** Penco Guardian Defiant II, knock-down lockers. Tops, Bottoms, Backs, Sides, and Shelves fabricated from 24 gauge sheet steel. Locker doors are fabricated from 14 gauge sheet steel. 6 inch legs are standard and can be deleted as a no cost option.

**Door Frame:** Channel shape, not less than 16 gauge steel. Provide vertical door frame members with additional 3/8 inch (9.5 mm) flange as a continuous door strike. Intermediate cross frame members are standard on double and triple tier lockers.

**Single Point Latch Doors:** One piece sheet steel with full channel formation on lock side, channel formation on hinge side, right angle formations across top and bottom, with holes for attaching number plates. All doors up to 18 inches wide and 20 inches or higher will include a 3.5 inch wide 18 gauge vertical reinforcing pan welded to the hinge side

flange, top and bottom angle formations, and inner face of door. Doors over 18 inches wide by 20 inches or higher will include a full width, partial height horizontal 18 gauge pan concealing the rear of the recessed pocket and welded on all 4 sides.

**Ventilation:** Flush door front with no exposed louvers and air flow slots located in top and bottom flanges of door.

**Hinges: Continuous type:** 16 gauge piano hinge measuring full height of door. Welded to door and attached to locker frame using steel rivets.

#### 2.04 DOOR HANDLES AND LATCHING

**1, 2 and 3 Tier Featuring Single Point Latching:** Defiant II single point latching with recessed drawn and brushed stainless steel pocket fastened to the door with two tabs and a positive tamper-resistant decorative fastener. Depth shall be sufficient to prevent a standard combination padlock, built-in combination lock, or key lock from protruding beyond door face.

**Locking Device:** 11 gauge steel hasp welded to locker frame; include surface for engaging the horizontal bolt of a built-in combination or key lock and anti-pry lug and slot to deter prying open when locked. Firmly secure rubber silencers to locker frame.

**Alternate Locking Device:** 11 gauge steel hasp welded to locker frame; include surface for secure wrap around vertical engagement by a built-in rotary-type lock to deter prying open when locked. Hasp must be adaptable to common horizontal throw locker lock and padlock use. Firmly secure rubber silencers to locker frame.

#### 2.05 INTERIOR EQUIPMENT

ADA-Compliant Lockers: (Recessed Handles with Multi-Point Latch): Single Tier: Hat shelf 48 inches from locker bottom or lower as required by base condition. Double Tier: Only bottom opening, a shelf placed 15 inches off the floor or lower as required by base condition.

#### 2.06 FABRICATION

Fabrication shall be on the unit principle, each locker with individual door and frame, individual top, bottom, back, and shelves, with common intermediate divisions separating compartments.

**Finish:** High quality powder coat paint finish applied in strict adherence to paint manufacturer's specifications to provide optimum appearance and performance. Finishes releasing VOCs are not acceptable. Standard coating thickness is 1 mil dry film thickness minimum. Powder Coat Plus option increases thickness to 2 mil minimum. Colors as selected from manufacturer's standard colors.

**Alternative Finishes:** Custom color match, Anti Graffiti, antimicrobial, TGIC and high performance finishes are available.

### PART 3 – EXECUTION

#### 3.01 EXAMINATION

Do not begin installation until substrates and bases have been properly prepared. If substrate and bases are the responsibility of another installer, notify Architect of unsatisfactory preparation before proceeding.

#### 3.02 INSTALLATION

Install metal lockers and accessories at locations shown in accordance with manufacturer's instructions. Install lockers plumb, level, and square. Anchor lockers to floor and wall at intervals recommended by the manufacturer. Bolt adjoining locker units together to provide rigid installation.

#### 3.03 ADJUSTING

Adjust doors and latches to operate without binding. Verify that latches are operating satisfactorily. Adjust built-in locks to prevent binding of dial or key and ensure smooth operation prior to substantial completion.

Touch-up with factory-supplied paint and repair or replace damaged products before substantial completion.

#### 3.04 PROTECTION

Protect installed products until completion of project.

Penco Products, Inc. reserves the right to vary specifications consistent with a policy of continuous product improvement.

Full MasterFormat Specifications can be found on [pencoproducts.com](http://pencoproducts.com).

## Invincible II™ Lockers (KD)

### PART 1 – GENERAL

#### 1.01 SECTION INCLUDES

Heavy Duty Knocked Down Lockers

#### 1.02 REFERENCES

ADAAG - Americans with Disabilities Act, Accessibility Guidelines.

#### 1.03 SUBMITTALS

Submit under provisions of Section 01 33 00. Shop Drawings shall show dimensioned plans, elevations, and sections.

#### 1.04 DELIVERY, STORAGE, AND HANDLING

Store products in manufacturer's unopened packaging until ready for installation to protect the locker finish and adjacent surfaces from damage.

### PART 2 – PRODUCTS

#### 2.01 MANUFACTURER

Penco Products, Inc. or approved equal based upon ability to provide product compliant with specifications of the product selected. Provide only metal lockers fabricated in the United States by a single domestic manufacturer.

#### 2.02 MATERIALS

**Steel:** All Penco standard lockers are constructed using prime grade mild cold-rolled sheet steel free from surface imperfection meeting ASTM A1008 and capable of taking a high-grade enamel powder coat finish. Alternate material: Sheet steel components shall be fabricated using zinc-coated steel meeting ASTM A879 and finished in the same manner. Forged steel coat hooks with balled ends and truss fin head bolts and hex nuts will be zinc coated and supplied for all lockers unless otherwise indicated.

**Greenguard:** Lockers shall be GREENGUARD Gold Certified by UL Environment through the GREENGUARD Certification Program.

#### 2.03 HEAVY DUTY LOCKERS

**Acceptable Product:** Penco Invincible II, knocked-down lockers. Tops, Bottoms, Sides, and Shelves shall be fabricated from 16 gauge and backs from 18 gauge sheet steel. Locker doors shall be 14 gauge. 6 inch legs are standard and can be deleted as a no cost option.

**Door Frame:** Channel shape, not less than 16 gauge steel. Provide vertical door frame members with additional 3/8 inch (9.5 mm) flange as a continuous door strike. Intermediate cross frame members are standard on double and triple tier lockers.

**Multi-Point Latch Doors:** One piece sheet steel with full channel formation of adequate depth to fully conceal lock bar on lock side, channel formation on hinge side, right

angle formations across top and bottom, with holes for attaching number plates. Doors over 15 inches wide by 60 inches or 72 inches high will include a 3 inch wide 20 gauge full height reinforcing pan welded to inside face of door at 6 inch centers.

**Ventilation:** Doors and locker sides have standard 3/4 inch (19 mm) wide by 1-1/2 inch (38 mm) high diamond-shaped perforations. Doors less than 20 inches tall have 7/16 inch (11 mm) wide by 15/16 inch (24 mm) high diamond-shaped perforations.

**Hinges:** Two inch high, double spun, full loop, tight pin, projection welded to door frame and securely fastened to the door with steel rivets. Provide three 2 inch five-knuckle hinges on doors over 48 inches high and two 2 inch high five-knuckle hinges on all other doors.

#### 2.04 DOOR HANDLES AND LATCHING 1, 2 and 3 Tier Featuring Multi-point

**Latching:** Classic III Multi-point latching with recessed handle activated by a 14 gauge finger-lift control handle in a 22 gauge drawn and brushed stainless steel pocket fastened to the door with two tabs and a positive tamper-resistant decorative fastener. Depth shall be sufficient to prevent a standard combination padlock, built-in combination lock, or key lock from protruding beyond door face. Nylon lift trigger accommodates use of 9/32 inch padlock. Doors over 48 inches high shall use glass-filled nylon clips to engage the door frame and hold the door shut at three points. All other doors engage at two points.

**Locking Device:** Positive, automatic type, whereby locker may be locked when open, then closed without unlocking. Firmly secure one rubber silencer in frame at each latch hook.

**4-9 Tier Box Lockers:** Punch doors for use with padlocks or built-in locks. Equip doors for use with padlocks with an 18 gauge combination door pull, staple, and lock hole cover plate with integral friction catch.

#### 2.05 INTERIOR EQUIPMENT

**ADA-Compliant Lockers:** Single Tier: Hat shelf 48 inches from locker bottom or lower as required by base condition. Double Tier: Only bottom opening, a shelf placed 15 inches off the floor or lower as required by base condition.

#### 2.06 FABRICATION

Fabrication shall be on the unit principle, each locker with individual door and frame, individual top, bottom, back, and shelves, with common intermediate divisions separating compartments.

**Finish:** High quality powder coat paint finish applied in strict adherence to paint manufacturer's specifications to provide optimum appearance and performance. Finishes releasing VOCs are not acceptable. Standard coating thickness is 1 mil dry film thickness minimum. Powder Coat Plus option increases thickness to 2 mil minimum. Colors as selected from manufacturer's standard colors. All locker body components shall match color of door and frame.

Alternative Finishes: Custom color match, Anti Graffiti, antimicrobial, TGIC and high performance finishes are available.

### PART 3 – EXECUTION

#### 3.01 EXAMINATION

Do not begin installation until substrates and bases have been properly prepared. If substrate and bases are the responsibility of another installer, notify Architect of unsatisfactory preparation before proceeding.

#### 3.02 INSTALLATION

Install metal lockers and accessories at locations shown in accordance with manufacturer's instructions. Install lockers plumb, level, and square. Anchor lockers to floor and wall at intervals recommended by the manufacturer. Bolt adjoining locker units together to provide rigid installation.

#### 3.03 ADJUSTING

Adjust doors and latches to operate without binding. Verify that latches are operating satisfactorily. Adjust built-in locks to prevent binding of dial or key and ensure smooth operation prior to substantial completion.

Touch-up with factory-supplied paint and repair or replace damaged products before substantial completion.

#### 3.04 PROTECTION

Protect installed products until completion of project.

Penco Products, Inc. reserves the right to vary specifications consistent with a policy of continuous product improvement.

Full MasterFormat Specifications can be found on [pencoproducts.com](http://pencoproducts.com).



## Invincible II Defiant™ II Single Point Latch (SPL)

### PART 1 – GENERAL

#### 1.01 SECTION INCLUDES

Standard Knocked Down Lockers

#### 1.02 REFERENCES

ADAAG - Americans with Disabilities Act, Accessibility Guidelines.

#### 1.03 SUBMITTALS

Submit under provisions of Section 01 33 00. Shop Drawings shall show dimensioned plans, elevations, and sections.

#### 1.04 DELIVERY, STORAGE, AND HANDLING

Store products in manufacturer's unopened packaging until ready for installation to protect the locker finish and adjacent surfaces from damage.

### PART 2 – PRODUCTS

#### 2.01 MANUFACTURER

Penco Products, Inc. or approved equal based upon ability to provide product compliant with specifications of the product selected. Provide only metal lockers fabricated in the United States by a single domestic manufacturer.

Lockers shall be GREENGUARD Gold Certified by UL Environment through the GREENGUARD Certification Program.

#### 2.02 MATERIALS

**Steel:** All All Penco standard lockers are constructed using prime grade steel free from surface imperfection suitable for powder coating. Alternate material: Prime grade steel shall be fabricated using galvanneal steel and finished in the same manner. Forged steel coat hooks with balled ends and truss fin head bolts and hex nuts will be zinc coated and supplied for all lockers unless otherwise indicated.

#### 2.03 STANDARD LOCKERS

**Acceptable Product:** Penco Invincible II Defiant II, knocked down lockers. Tops, Bottoms, Sides, and Shelves shall be fabricated from 16 gauge and backs from 18 gauge sheet steel. Locker doors shall be 14 gauge. 6 inch legs are standard and can be deleted as a no cost option.

**Door Frame:** Channel shape, not less than 16 gauge steel. Provide vertical door frame members with additional 3/8 inch (9.5 mm) flange as a continuous door strike. Intermediate cross frame members are standard on double and triple tier lockers.

**Single Point Latch Doors:** One piece sheet steel with full channel formation on lock side, channel formation on hinge side, right angle formations across top and bottom, with holes for attaching number plates. All doors up to 18 inches wide and 20 inches or higher will include a 3.5 inch wide 18 gauge vertical

reinforcing pan welded to the hinge side flange, top and bottom angle formations, and inner face of door. Doors over 18 inches wide by 20 inches or higher will include a full width, partial height horizontal 18 gauge pan concealing the rear of the recessed pocket and welded on all 4 sides.

**Ventilation:** Doors and locker sides as standard have 3/4 inch (19 mm) wide by 1-1/2 inch (38 mm) high diamondshaped perforations. Doors less than 20 inches tall have 7/16 inch (11 mm) wide by 15/16 inch (24 mm) high diamond-shaped perforations. Both doors and sides are available as solid as a no charge option.

**Hinges: Continuous type:** 16 gauge piano hinge measuring full height of door. Welded to door and attached to locker frame using steel rivets.

#### 2.04 DOOR HANDLES AND LATCHING

**1, 2 and 3 Tier Featuring Single Point Latching:** Defiant II single point latching with recessed drawn and brushed stainless steel pocket fastened to the door with two tabs and a positive tamper-resistant decorative fastener. Depth shall be sufficient to prevent a standard combination padlock, built-in combination lock, or key lock from protruding beyond door face.

**Locking Device:** 11 gauge steel hasp welded to locker frame; include surface for engaging the horizontal bolt of a built-in combination or key lock and anti-pry lug and slot to deter prying open when locked. Firmly secure rubber silencers to locker frame.

**Alternate Locking Device:** 11 gauge steel hasp welded to locker frame; include surface for secure wrap around vertical engagement by a built-in rotary-type lock to deter prying open when locked. Hasp must be adaptable to common horizontal throw locker lock and padlock use. Firmly secure rubber silencers to locker frame.

#### 2.05 INTERIOR EQUIPMENT

**ADA-Compliant Lockers: (Recessed Handles with Multi-Point Latch):** Single Tier: Hat shelf 48 inches from locker bottom or lower as required by base condition. Double Tier: Only bottom opening, a shelf placed 15 inches off the floor or lower as required by base condition.

#### 2.06 FABRICATION

Fabrication shall be on the unit principle, each locker with individual door and frame, individual top, bottom, back, and shelves, with common intermediate divisions separating compartments.

**Finish:** High quality powder coat paint finish applied in strict adherence to paint manufacturer's specifications to provide optimum appearance and performance.

Finishes releasing VOCs are not acceptable. Standard coating thickness is 1 mil dry film thickness minimum. Powder Coat Plus option increases thickness to 2 mil minimum. Colors as selected from manufacturer's standard colors.

**Alternative Finishes:** Custom color match, Anti Graffiti, antimicrobial, TGIC and high performance finishes are available.

### PART 3 – EXECUTION

#### 3.01 EXAMINATION

Do not begin installation until substrates and bases have been properly prepared. If substrate and bases are the responsibility of another installer, notify Architect of unsatisfactory preparation before proceeding.

#### 3.02 INSTALLATION

Install metal lockers and accessories at locations shown in accordance with manufacturer's instructions. Install lockers plumb, level, and square. Anchor lockers to floor and wall at intervals recommended by the manufacturer. Bolt adjoining locker units together to provide rigid installation.

#### 3.03 ADJUSTING

Adjust doors and latches to operate without binding. Verify that latches are operating satisfactorily. Adjust built-in locks to prevent binding of dial or key and ensure smooth operation prior to substantial completion.

Touch-up with factory-supplied paint and repair or replace damaged products before substantial completion.

#### 3.04 PROTECTION

Protect installed products until completion of project.

Penco Products, Inc. reserves the right to vary specifications consistent with a policy of continuous product improvement.

Full MasterFormat Specifications can be found on [pencoproducts.com](http://pencoproducts.com).

## Welded Gen2 Lockers (Welded)

### PART 1 – GENERAL

#### 1.01 SECTION INCLUDES

Heavy Duty Welded Lockers

#### 1.02 REFERENCES

ADAAG - Americans with Disabilities Act, Accessibility Guidelines.

#### 1.03 SUBMITTALS

Submit under provisions of Section 01 33 00. Shop Drawings shall show dimensioned plans, elevations, and sections.

#### 1.04 DELIVERY, STORAGE, AND HANDLING

Store products in manufacturer's unopened packaging until ready for installation to protect the locker finish and adjacent surfaces from damage.

### PART 2 – PRODUCTS

#### 2.01 MANUFACTURER

Penco Products, Inc. or approved equal based upon ability to provide product compliant with specifications of the product selected. Provide only metal lockers fabricated in the United States by a single domestic manufacturer.

#### 2.02 MATERIALS

**Steel:** All Penco standard lockers are constructed using prime grade mild cold-rolled sheet steel free from surface imperfection meeting ASTM A1008 and capable of taking a high-grade enamel powder coat finish. Alternate material: Sheet steel components shall be fabricated using zinc-coated steel meeting ASTM A879 and finished in the same manner. Forged steel coat hooks with balled ends and truss fin head bolts and hex nuts will be zinc coated and supplied for all lockers unless otherwise indicated.

**Greenguard:** Lockers shall be GREENGUARD Gold Certified by UL Environment through the GREENGUARD Certification Program.

#### 2.03 HEAVY DUTY LOCKERS

**Acceptable Product:** Penco Welded Gen2 lockers. Tops, Bottoms, Sides, and Shelves shall be fabricated from 16 gauge and backs from 18 gauge sheet steel. Locker doors shall be 14 gauge.

**Door Frame:** Channel shape, not less than 16 gauge steel. Provide vertical door frame members with additional 3/8 inch (9.5 mm) flange as a continuous door strike. Intermediate cross frame members are standard on double and triple tier lockers.

**Multi-Point Latch Doors:** One piece sheet steel with full channel formation of adequate depth to fully conceal lock bar on lock side, channel formation on hinge side, right angle formations across top and bottom, with holes for attaching number plates. Doors

over 15 inches wide by 60 inches or 72 inches high will include a 3 inch wide 20 gauge full height reinforcing pan welded to inside face of door at 6 inch centers.

**Ventilation:** Doors and locker sides have standard 3/4 inch (19 mm) wide by 1-1/2 inch (38 mm) high diamond-shaped perforations. Doors less than 20 inches tall have 7/16 inch (11 mm) wide by 15/16 inch (24 mm) high diamond-shaped perforations.

**Hinges:** Continuous type: 16 gauge piano hinge measuring full height of door. Welded to door and attached to locker frame using steel rivets.

#### 2.04 DOOR HANDLES AND LATCHING

**1, 2 and 3 Tier Featuring Multi-point Latching:** Classic III Multi-point latching with recessed handle activated by a 14 gauge finger-lift control handle in a 22 gauge drawn and brushed stainless steel pocket fastened to the door with two tabs and a positive tamper-resistant decorative fastener. Depth shall be sufficient to prevent a standard combination padlock, built-in combination lock, or key lock from protruding beyond door face. Nylon lift trigger accommodates use of 9/32 inch padlock. Doors over 48 inches high shall use glass-filled nylon clips to engage the door frame and hold the door shut at three points. All other doors engage at two points.

**Locking Device:** Positive, automatic type, whereby locker may be locked when open, then closed without unlocking. Firmly secure one rubber silencer in frame at each latch hook.

**4-9 Tier Box Lockers:** Punch doors for use with padlocks or built-in locks. Equip doors for use with padlocks with an 18 gauge combination door pull, staple, and lock hole cover plate with integral friction catch.

#### 2.05 INTERIOR EQUIPMENT

**ADA-Compliant Lockers (Recessed Handles with Multi-Point Latch):** Single Tier: Hat shelf 48 inches from locker bottom or lower as required by base condition. Double Tier: Only bottom opening, a shelf placed 15 inches off the floor or lower as required by base condition.

#### 2.06 FABRICATION

Pre-assemble lockers by welding into one piece structures in groupings most practical for job requirements, welds free of burrs; maximum width of group to be 54 inches (1.371 m); no bolts, nuts, or rivets allowed in assembly of main locker groups.

**Finish:** High quality powder coat paint finish applied in strict adherence to paint manufacturer's specifications to provide optimum appearance and performance. Finishes releasing VOCs are not acceptable.

Standard coating thickness is 1 mil dry film thickness minimum. Powder Coat Plus option increases thickness to 2 mil minimum. Colors as selected from manufacturer's standard colors. All locker body components shall match color of door and frame.

Alternative finishes: Custom color match, Anti Graffiti, antimicrobial, TGIC and high performance finishes are available.

### PART 3 – EXECUTION

#### 3.01 EXAMINATION

Do not begin installation until substrates and bases have been properly prepared. If substrate and bases are the responsibility of another installer, notify Architect of unsatisfactory preparation before proceeding.

#### 3.02 INSTALLATION

Install metal lockers and accessories at locations shown in accordance with manufacturer's instructions. Install lockers plumb, level, and square. Anchor lockers to floor and wall at intervals recommended by the manufacturer. Bolt adjoining locker units together to provide rigid installation.

#### 3.03 ADJUSTING

Adjust doors and latches to operate without binding. Verify that latches are operating satisfactorily. Adjust built-in locks to prevent binding of dial or key and ensure smooth operation prior to substantial completion.

Touch-up with factory-supplied paint and repair or replace damaged products before substantial completion.

#### 3.04 PROTECTION

Protect installed products until completion of project.

Penco Products, Inc. reserves the right to vary specifications consistent with a policy of continuous product improvement.

Full MasterFormat Specifications can be found on [pencoproducts.com](http://pencoproducts.com).

## Welded GEN2 Defiant™ II Single Point Latch (SPL)

### PART 1 – GENERAL

#### 1.01 SECTION INCLUDES

Standard Knocked Down Lockers

#### 1.02 REFERENCES

ADAAG - Americans with Disabilities Act, Accessibility Guidelines.

#### 1.03 SUBMITTALS

Submit under provisions of Section 01 33 00. Shop Drawings shall show dimensioned plans, elevations, and sections.

#### 1.04 DELIVERY, STORAGE, AND HANDLING

Store products in manufacturer's unopened packaging until ready for installation to protect the locker finish and adjacent surfaces from damage.

### PART 2 – PRODUCTS

#### 2.01 MANUFACTURER

Penco Products, Inc. or approved equal based upon ability to provide product compliant with specifications of the product selected. Provide only metal lockers fabricated in the United States by a single domestic manufacturer.

Lockers shall be GREENGUARD Gold Certified by UL Environment through the GREENGUARD Certification Program.

#### 2.02 MATERIALS

**Steel:** All Penco standard lockers are constructed using prime grade steel free from surface imperfection suitable for powder coating. Alternate material: Prime grade steel shall be fabricated using galvanized steel and finished in the same manner. Forged steel coat hooks with ball ends and truss fin head bolts and hex nuts will be zinc coated and supplied for all lockers unless otherwise indicated.

#### 2.03 STANDARD LOCKERS

**Acceptable Product:** Welded GEN2 lockers. Tops, Bottoms, Sides, and Shelves shall be fabricated from 16 gauge and backs from 18 gauge sheet steel. Locker doors shall be 14 gauge.

**Door Frame:** Channel shape, not less than 16 gauge steel. Provide vertical door frame members with additional 3/8 inch (9.5 mm) flange as a continuous door strike. Intermediate cross frame members are standard on double and triple tier lockers.

**Single Point Latch Doors:** One piece sheet steel with full channel formation on lock side, channel formation on hinge side, right angle formations across top and bottom, with holes for attaching number plates. All doors up to 18 inches wide and 20 inches or higher will include a 3.5 inch wide 18 gauge vertical reinforcing pan welded to the hinge side flange, top and bottom angle formations,

and inner face of door. Doors over 18 inches wide by 20 inches or higher will include a full width, partial height horizontal 18 gauge pan concealing the rear of the recessed pocket and welded on all 4 sides.

**Ventilation:** Doors and locker sides as standard have 3/4 inch (19 mm) wide by 1-1/2 inch (38 mm) high diamondshaped perforations. Doors less than 20 inches tall have 7/16 inch (11 mm) wide by 15/16 inch (24 mm) high diamond-shaped perforations. Both doors and sides are available as solid as a no charge option.

**Hinges: Continuous type:** 16 gauge piano hinge measuring full height of door. Welded to door and attached to locker frame using steel rivets.

#### 2.04 DOOR HANDLES AND LATCHING

**1, 2 and 3 Tier Featuring Single Point Latching:** Defiant II single point latching with recessed drawn and brushed stainless steel pocket fastened to the door with two tabs and a positive tamper-resistant decorative fastener. Depth shall be sufficient to prevent a standard combination padlock, built-in combination lock, or key lock from protruding beyond door face.

**Locking Device:** 11 gauge steel hasp welded to locker frame; include surface for engaging the horizontal bolt of a built-in combination or key lock and anti-pry lug and slot to deter prying open when locked. Firmly secure rubber silencers to locker frame.

**Alternate Locking Device:** 11 gauge steel hasp welded to locker frame; include surface for secure wrap around vertical engagement by a built-in rotary-type lock to deter prying open when locked. Hasp must be adaptable to common horizontal throw locker lock and padlock use. Firmly secure rubber silencers to locker frame.

#### 2.05 INTERIOR EQUIPMENT

**ADA-Compliant Lockers: (Recessed Handles with Multi-Point Latch):** Single Tier: Hat shelf 48 inches from locker bottom or lower as required by base condition. Double Tier: Only bottom opening, a shelf placed 15 inches off the floor or lower as required by base condition.

#### 2.06 FABRICATION

Fabrication shall be on the unit principle, each locker with individual door and frame, individual top, bottom, back, and shelves, with common intermediate divisions separating compartments.

**Finish:** High quality powder coat paint finish applied in strict adherence to paint manufacturer's specifications to provide optimum appearance and performance. Finishes releasing VOCs are not acceptable. Standard coating thickness is 1 mil dry

film thickness minimum. Powder Coat Plus option increases thickness to 2 mil minimum. Colors as selected from manufacturer's standard colors.

**Alternative Finishes:** Custom color match, Anti Graffiti, antimicrobial, TGIC and high performance finishes are available.

### PART 3 – EXECUTION

#### 3.01 EXAMINATION

Do not begin installation until substrates and bases have been properly prepared. If substrate and bases are the responsibility of another installer, notify Architect of unsatisfactory preparation before proceeding.

#### 3.02 INSTALLATION

Install metal lockers and accessories at locations shown in accordance with manufacturer's instructions. Install lockers plumb, level, and square. Anchor lockers to floor and wall at intervals recommended by the manufacturer. Bolt adjoining locker units together to provide rigid installation.

#### 3.03 ADJUSTING

Adjust doors and latches to operate without binding. Verify that latches are operating satisfactorily. Adjust built-in locks to prevent binding of dial or key and ensure smooth operation prior to substantial completion.

Touch-up with factory-supplied paint and repair or replace damaged products before substantial completion.

#### 3.04 PROTECTION

Protect installed products until completion of project.

Penco Products, Inc. reserves the right to vary specifications consistent with a policy of continuous product improvement.

Full MasterFormat Specifications can be found on [pencoproducts.com](http://pencoproducts.com).

# Specifications

## Steel Locker Accessories

### (Welded Gen2, Vanguard, Guardian, and Invincible II)

**Closed Bases:** Provide 18 gauge closed metal front and end bases on knocked down lockers having legs. Front bases shall be installed between legs without overlap or exposed fasteners. Provide end bases on exposed ends. Bases shall be finished to match lockers.

**Locks:** (Specify lock brand if desired, location and locker type if appropriate.) All locks shall have bolt types appropriate to the mode of locker operations.

**Built-In Flat Key Locks:** Lockers shall be equipped with built-in flat key type locks. All locks shall be master keyed to the same series. Provide two (2) keys for each lock and two (2) master keys for the system.

**Built-In Grooved Key Locks (Pin Tumbler):** Lockers shall be equipped with built-in grooved key type locks. All locks shall be master keyed to the same series. Provide two (2) keys for each lock and two (2) master keys for the system.

**Built-in Combination Locks:** Lockers shall be equipped with built-in combination locks. Locks shall have three-number combination dialing and be capable of at least five different combination changes. Master key, combination change key, if required, and combination control charts shall be provided to the owner.

**Padlocks-Combination Type:** Master keyed combination type padlocks shall be provided for all locker doors. Locks shall have three-number combination dialing. Master key shall be provided to the owner.

**Coin Operated Locks:** (Certain locker types and sizes will not accept coin locks; verify with locker manufacturer). Coin operated locks shall be provided for lockers. Locks shall be (select one): Coin return/deposit type; Coin collect/pay type; Coin fee shall be (select one): One (1) Quarter; Two (2) Quarters. Locks are to be installed on lockers using security-type machine screws.

**Visual Perforation 16 Ga. & 18 Ga.:** Locker doors shall be provided with 5/8" x 1-1/8" rectangular visual perforations.

**Round Perforation:** 24 gauge (Backs, Sides, Tops, Bottoms or Shelves) are to be punched with 1/2" diameter perforations

grouped in 42 hole patterns. (For sides and backs, specify full perforations for maximum number of holes in the part, or standard perforations consisting of one group top and bottom in single-tier; one group each compartment in double-tier or box lockers).

**Fire Extinguisher Door:** Lockers designated on drawings to contain fire extinguisher shall be double tier type with upper door to have a glazed opening. Locks are to be omitted on fire extinguisher doors.

**Waste Bin Doors:** Lockers designated on drawings to contain waste bins shall be provided with a door cut-out with a top hinged internal flap door over the cut-out. Locks are to be omitted on waste bin doors.

**Center Partitions:** Lockers shall have 24 gauge, full depth, vertical partitions between bottom and shelf.

**Recess Trim:** Vertical and/or horizontal recessed trim shall be provided where shown. Trim shall be formed from 18 gauge sheet steel and have a 3" face dimension. Trim shall be furnished in standard lengths as long as practical and attached to lockers with concealed clips. Finish caps and splices shall be provided as required. Trim shall be finished to match lockers.

**Zee Bases:** Knocked down lockers shall be furnished with 4" high or 6" high 14 gauge zee base flanged outward at top for support of lockers and inward at bottom for anchoring to the floor. Not for use for Stadium and Welded Lockers.

**Front Filler:** Fillers for spaces between lockers or between lockers and a wall shall be fabricated from 20 gauge sheet steel and formed in an angle shape. Slip joint angles shall be 20 gauge sheet steel formed in an angle shape with a slot on one leg to form a pocket which provides adjustable mating with the angle filler. Attachment shall be by means of concealed fasteners. Fillers shall be finished to match lockers.

**Exposed Locker Sides:** Shall be furnished in 16 gauge without any extra holes.

**Boxed Finished End Panels:** Boxed finished

end panels shall be installed on all exposed ends of lockers. They shall be formed from minimum 16 gauge sheet steel to match locker depth and height, and shall have a 1" edge dimension. All panels shall be installed with concealed fasteners. Panels shall be finished to match lockers.

**Continuous Slope Hood:** Lockers shall be provided with continuous slope hoods formed from 18 gauge sheet steel with a slope that has a rise equal to 1/3 of the locker depth (18-1/2"), plus a 1" vertical rise at the front. Tops shall be provided in lengths as long as practical. Provide slip joints without visible fasteners at splice locations. Necessary end closures shall be provided. Tops shall be finished to match lockers.

#### Unit Slope Tops Vanguard and Guardian Lockers:

Lockers shall be provided with 24 gauge individual sloping tops. Tops shall be formed to a slope which rises 1/3 of the locker depth. Tops shall be finished to match lockers.

**Benches:** Locker benches shall be laminated selected hardwood, 1-1/4" full finished thickness. All corners are to be rounded and sanded. Surfaces shall be finished with two coats of clear lacquer. Bench tops are to be 9-1/2" wide and furnished in lengths of 3' through 12' (even foot increments).

**Heavy Duty Bench Pedestal:** Pedestals shall consist of steel tubing with 11 gauge steel flanges welded to each end. The overall height of pedestal shall be 16-1/4". Pedestals are to be finished to match the lockers.

#### Stainless Steel Free Standing Bench Pedestal:

Shall be 2" diameter brushed 16 ga. stainless steel formed into a trapezoid. Bottom shall be 14" wide with two 5/16" diameter holes. Pedestal shall be 16-1/4" high for an overall bench height of 17-1/2". Top flange shall have four 5/16" diameter holes for fastening to the bench. Bench can be moveable or may be anchored.

## Defiant™ II Single Point Latch (SPL)

When specifying Guardian, Welded Gen2, Invincible II, Angle Iron or Patriot® lockers with Defiant II Single Point Latch doors, substitute the following specifications for the "Door Handle & Latching ..." section referring to 1-tier to 3-tier doors.

**Doors:** All doors shall be formed from 14 gauge steel. Formations shall be channel shape on the hinge and latch sides, and right angle formations across the top and bottom. Top and bottom flanges shall have one 90 degree bend. The latch side formation shall include a slot to fully engage an additional anti-pry lug integral with the padlock hasp limiting motion in any direction. On doors measuring 12" through 18" wide, additional reinforcement shall be in the form of a vertical 18 gauge pan measuring 3-1/2" wide MIG-welded to the top and bottom flanges and hinge side channel, with an additional 1/2" flange spot welded a maximum of 8" on center to the door skin to maximize door rigidity. Doors measuring more than 18" wide shall be reinforced using a 20 gauge horizontal box pan MIG-welded a maximum of 8" on center to the hinge and latch side channels, and spot welded to the door skin a maximum of 8" on center along the upper and lower pan edge for optimum strength, quiet operation and stiffness. Door shall be manufactured to allow ventilation and stiffness.

**Hinge:** 16 gauge continuous hinges (full length of the door) are welded to the door and riveted to the frame.

**Door Handle & Latching 1, 2 & 3 Tier:** Handles shall be recessed in the door. The formed pocket shall be brushed stainless steel securely fastened to the door with two lugs plus a positive tamper resistant fastener. The pocket shall be of sufficient depth to prevent a combination padlock, built-in combination lock or key lock from protruding beyond the face of the door. An anti-pry lock alignment bracket shall be supplied for use with built-in combination locks to facilitate installation, adjustment and to increase resistance to prying by mechanically engaging the hasp assembly. A lock hole cover plate shall be provided for use with padlocks. All pockets shall be drawn stainless steel for superior strength. Door pull shall be formed in the pocket. Pocket and pull shall be integral. Doors shall have a catch to retain unlocked doors in the closed position. Locking shall be accomplished by an 11 gauge lug welded to the locker frame. The lug shall include a surface for the bolt of a built-in combination or key lock to engage. A padlock staple shall protrude through the pocket. The hasp assembly shall include an additional lug that mechanically engages a slot on the latch side door formation preventing the spreading of the door from the frame channel. A separate bracket shall be field installed to brace the lock hasp assembly against the locker side to prevent twisting of the frame. Rubber door silencers shall be firmly attached to the locker frame.

Penco Products, Inc. reserves the right to vary specifications consistent with a policy of continuous product improvement.

Full MasterFormat Specifications can be found on [pencoproducts.com](http://pencoproducts.com).

Defiant II 1-tier lockers with built-in combination locks, finished end panels and custom flat tops.

### The Single Point Alternative

- Greater tamper resistance
- Increased rigidity
- Improved Performance with built-in locks

The Defiant II Single Point Latch (SPL) option is for those desiring a heavy gauge door offering improved security with the low maintenance inherent in a door with no moving parts.

Each door has a patented deep draw stainless steel pocket handle with an integral door pull. The doors can be locked with a conventional padlock, using the padlock staple protruding through the recessed handle (recommended) or with a built-in lock.

Doors are stiffened with either a vertical or horizontal pan, as shown at the right.

Doors that have any type of perforations including louvers will require the perforations/louvers to be modified from the standard patterns and sizes to allow for either type of pan to be used. Contact a Penco representative for details.



For KD Lockers



For Welded Lockers



Vertical Pan



Horizontal Pan



#### Anti-Pry/Lock Alignment Bracket

Defeats prying attempts by capturing the door flange and preventing separation from the door channel.



#### Side Stiffener

This full-depth stiffener prevents frame channel and side-sheet torquing during break-in attempts. For use at left ends of 24 gauge Guardian K.D. bodies of 1 & 2 tier lockers with combination locks only.



Defiant II 2-tier Welded Gen2 lockers with slope hoods, boxed finished end panels and custom bases & benches.



## Fully Framed Stadium™ Lockers (Knocked Down)

### PART 1 - GENERAL

#### 1.01 SECTION INCLUDES

Heavy Duty Knocked Down Fully Framed Stadium Open Front Lockers

#### 1.02 REFERENCES

ADAAG - Americans with Disabilities Act, Accessibility Guidelines.

#### 1.03 SUBMITTALS

Submit under provisions of Section 01 33 00. Shop Drawings shall show dimensioned plans, elevations, and sections. For each product specified, two complete sets of color chips representing manufacturer's full range of available colors and finishes.

#### 1.04 DELIVERY, STORAGE AND HANDLING

Store products in manufacturer's unopened packaging until ready for installation to protect the locker finish and adjacent surfaces from damage.

### PART 2 - PRODUCTS

#### 2.01 MANUFACTURER

Acceptable Manufacturer is Penco Products, Inc. which is located at 1820 Stonehenge Dr., Greenville, NC 27858.

Lockers shall be GREENGUARD Gold Certified by UL Environment through the GREENGUARD Certification Program.

#### 2.02 MATERIALS

**Steel:** All Penco standard lockers are constructed using prime grade steel free from surface imperfection capable of taking high grade enamel finish. Sheet steel components shall be zinc coated and free from surface imperfection and capable of taking high grade enamel finish. 13 gauge Expanded Metal Divisions that meet or exceed ASTM A1008/A1008M captured on all sides by the tubular shaped frame assembly. Self-tapping screws and rivets. Provide only metal lockers that conform to Made in US regulations.

#### 2.03 HEAVY DUTY OPEN FRONT PERSONAL EQUIPMENT LOCKERS

**Heavy Duty Lockers:** All locker body components made of cold rolled steel specially formed for added strength and rigidity and to ensure tight joints at fastening points.

**Locker Body Construction:** Steel specially formed for added strength and rigidity and to ensure tight joints at fastening points. Bottoms, tops and shelves made from 16 gauge steel. Sides are either 16 gauge solid or will be 16 gauge with diamond perforations (on 72 inch high only). Backs are solid 18 gauge steel; one piece. Tops and bottoms

with four sides formed at 90 degrees, welded to the fully framed channel with cast corner pieces. Channel Base is 4 inches or 6 inches high, made from 14 gauge sheet forming a "C" channel attached to locker bottom. Shelves with four sides formed to 90 degrees, front and back edge having a second bend. Locker body is tubular frame construction with cast steel interlocks to provide a true fully framed locker body construction. Hole spacing in locker body not exceeding 3 inches. Optional factory assembly of lockers (welded version only).

#### 2.04 INTERIOR EQUIPMENT

**Heavy Duty Fully Framed Stadium Lockers Without Doors:** Shelf located approximately 13 inches (330 mm) below top of locker. Hooks- two heavy duty single prong hooks with a diameter of 0.276 inches, mounted to shelf and designed to accept a coat rod and two single prong hooks with a diameter of 0.187 inches in rear, mounted to shelf.

**Interior Equipment Options:** Optional security box; 16 gauge lockable door with a 16 gauge side panel. The door is attached to the welded frame of the security box using a two-point hinge. The door is locked through a single point latch with a padlock or built in lock. A door pull shall be provided for use with padlocks. Security box door frame to be not less than 16 gauge formed to a channel shape. Vertical members to have an additional flange to provide a continuous door strike. 9 inch wide security box on 18 inch wide Stadium locker and 12 inch wide security box on 24 inch wide Stadium locker. Optional footlocker; recessed from locker frame. Front foot locker panel includes single point latch with padlock strike plate and vertical slots. 14 gauge lid of footlocker has a continuous hinge and also serves as a seat. Opening and closing of the lid is quieted by rubber bumpers mounted to the contact points. The seat lid is strengthened with two reinforcement channels welded to bottom. Lid/seat is supported by mounting side rails attached to the vertical posts. Optional coat rods using coat rod hooks mounted to shelf.

#### 2.05 ACCESSORIES

(See Full Product Specifications)

#### 2.06 FABRICATION

Fabricate lockers with fully framed construction, 8 male/female insertion points to provide the fully framed locker body, square, rigid, without warp, with metal faces flat and free

of distortion. Fabricated on the unit principle, each locker with individual door and frame, individual top, bottom, back and shelves. Verify dimensions and arrangement before fabrication.

**Finish:** Enamel powder coat paint finish electrostatically applied and properly cured to manufacturer's specifications for optimum performance. Finishes releasing VOC's and subject to out-gassing are not acceptable. Locker exterior and interior shall be painted the same color. Standard coating thickness is 1 to 1.2 mils (0.025 to 0.03 mm) dry film thickness minimum. Powder Coat Plus option is 2 to 2.2 mils (.05 to .055 mm). Colors as selected from manufacturer's standard colors.

**Alternative finishes:** Custom color match, Anti-Graffiti or Anti-Microbial finishes are available.

### PART 3 - EXECUTION

#### 3.01 EXAMINATION

Do not begin installation until substrates and bases have been properly prepared. If substrate and bases are the responsibility of another installer, notify Architect of unsatisfactory preparation before proceeding.

#### 3.02 INSTALLATION

Install metal lockers and accessories at locations shown in accordance with manufacturer's instructions. Install lockers plumb, level, and square. Work is not to progress until site meets necessary conditions. Anchor lockers to floor and wall at intervals of 36 inches (0.914 m) or less, as recommended by manufacturer. Bolt adjoining locker units together to provide rigid installation. Install sloping tops and metal fillers using condealed fasteners. Provide flush hairline joints against adjacent surfaces. Install benches by fastening bench tops to pedestals and securely anchoring to the floor using appropriate anchors for the floor material.

#### 3.03 ADJUSTING

Adjust doors and latches to operate without binding. Verify that latches are operating satisfactorily. Adjust built-in locks to prevent binding of dial or key and ensure smooth operation prior to substantial completion.

Touch-up with factory-supplied paint and repair or replace damaged products before substantial completion.

#### 3.04 PROTECTION

Protect installed products until completion of project.

## Fully Framed Stadium™ Lockers (Welded)

### PART 1 - GENERAL

#### 1.01 SECTION INCLUDES

Heavy Duty Welded Fully Framed Stadium Open Front Lockers

#### 1.02 REFERENCES

ADAAG - Americans with Disabilities Act, Accessibility Guidelines.

#### 1.03 SUBMITTALS

Submit under provisions of Section 01 33 00. Shop Drawings shall show dimensioned plans, elevations, and sections. For each product specified, two complete sets of color chips representing manufacturer's full range of available colors and finishes.

#### 1.04 DELIVERY, STORAGE AND HANDLING

Store products in manufacturer's unopened packaging until ready for installation to protect the locker finish and adjacent surfaces from damage.

### PART 2 - PRODUCTS

#### 2.01 MANUFACTURER

Acceptable Manufacturer is Penco Products, Inc. which is located at 1820 Stonehenge Dr., Greenville, NC 27858.

Lockers shall be GREENGUARD Gold Certified by UL Environment through the GREENGUARD Certification Program.

#### 2.02 MATERIALS

**Steel:** All Penco standard lockers are constructed using prime grade steel free from surface imperfection capable of taking high grade enamel finish. Sheet steel components shall be zinc coated and free from surface imperfection and capable of taking high grade enamel finish. 13 gauge Expanded Metal Divisions that meet or exceed ASTM A1008/A1008M captured on all sides by the tubular shaped frame assembly. Self-tapping screws and rivets. Provide only metal lockers that conform to Made in US regulations.

#### 2.03 HEAVY DUTY OPEN FRONT PERSONAL EQUIPMENT LOCKERS

**Heavy Duty Lockers:** All locker body components made of cold rolled steel specially formed for added strength and rigidity and to ensure tight joints at fastening points.

**Locker Body Construction:** Welded Shell. Steel specially formed for added strength and rigidity and to ensure tight joints at fastening points. Bottoms, tops and shelves made from 16 gauge steel. Sides are either 16 gauge solid or will be 16 gauge with diamond perforations (on 72 inch high only). Backs are solid 18 gauge steel;

one piece. Tops and bottoms with four sides formed at 90 degrees, welded to the fully framed channel with cast corner pieces. Channel Base is 4 inches or 6 inches high, made from 14 gauge sheet forming a "C" channel attached to locker bottom. Shelves with four sides formed to 90 degrees, front and back edge having a second bend. Locker body is welded shell with tubular framed construction with cast steel interlocks to provide a true fully framed locker body construction. Hole spacing in locker body not exceeding 3 inches. Factory assembly of lockers.

#### 2.04 INTERIOR EQUIPMENT

**Heavy Duty Fully Framed Stadium Lockers Without Doors:** Shelf located approximately 13 inches (330 mm) below top of locker. Hooks- two heavy duty single prong hooks with a diameter of 0.276 inches, mounted to shelf and designed to accept a coat rod and two single prong hooks with a diameter of 0.187 inches in rear, mounted to shelf.

**Interior Equipment Options:** Optional security box; 16 gauge lockable door with a 16 gauge side panel. The door is attached to the welded frame of the security box using a two-point hinge. The door is locked through a single point latch with a padlock or built in lock. A door pull shall be provided for use with padlocks. Security box door frame to be not less than 16 gauge formed to a channel shape. Vertical members to have an additional flange to provide a continuous door strike. 9 inch wide security box on 18 inch wide Stadium locker and 12 inch wide security box on 24 inch wide Stadium locker. Optional footlocker; recessed from locker frame. Front foot locker panel includes single point latch with padlock strike plate and vertical slots. 14 gauge lid of footlocker has a continuous hinge and also serves as a seat. Opening and closing of the lid is quieted by rubber bumpers mounted to the contact points. The seat lid is strengthened with two reinforcement channels welded to bottom. Lid/seat is supported by mounting side rails attached to the vertical posts. Optional coat rods using coat rod hooks mounted to shelf.

#### 2.05 ACCESSORIES

(See Full Product Specifications)

#### 2.06 FABRICATION

Fabricate lockers with fully framed construction, 8 male/female insertion points to provide the fully framed locker body, square, rigid, without warp, with metal faces flat and free of distortion. Fabricated on the unit

principle, each locker with individual door and frame, individual top, bottom, back and shelves. Verify dimensions and arrangement before fabrication.

**Finish:** Enamel powder coat paint finish electrostatically applied and properly cured to manufacturer's specifications for optimum performance. Finishes releasing VOC's and subject to out-gassing are not acceptable. Locker exterior and interior shall be painted the same color. Standard coating thickness is 1 to 1.2 mils (0.025 to 0.03 mm) dry film thickness minimum. Powder Coat Plus option is 2 to 2.2 mils (.05 to .055 mm). Colors as selected from manufacturer's standard colors.

**Alternative finishes:** Custom color match, Anti-Graffiti or Anti-Microbial finishes are available.

### PART 3 - EXECUTION

#### 3.01 EXAMINATION

Do not begin installation until substrates and bases have been properly prepared. If substrate and bases are the responsibility of another installer, notify Architect of unsatisfactory preparation before proceeding.

#### 3.02 INSTALLATION

Install metal lockers and accessories at locations shown in accordance with manufacturer's instructions. Install lockers plumb, level, and square. Work is not to progress until site meets necessary conditions. Anchor lockers to floor and wall at intervals of 36 inches (0.914 m) or less, as recommended by manufacturer. Bolt adjoining locker units together to provide rigid installation. Install sloping tops and metal fillers using condealed fasteners. Provide flush hairline joints against adjacent surfaces. Install benches by fastening bench tops to pedestals and securely anchoring to the floor using appropriate anchors for the floor material.

#### 3.03 ADJUSTING

Adjust doors and latches to operate without binding. Verify that latches are operating satisfactorily. Adjust built-in locks to prevent binding of dial or key and ensure smooth operation prior to substantial completion.

Touch-up with factory-supplied paint and repair or replace damaged products before substantial completion.

#### 3.04 PROTECTION

Protect installed products until completion of project.

## **PATRIOT** Fully Framed TA-50 Locker (Knocked Down)

### **PART 1 - GENERAL**

#### **1.01 SECTION INCLUDES**

Heavy Duty Knocked Down TA-50 Lockers

#### **1.02 REFERENCES**

ADAAG - Americans with Disabilities Act, Accessibility Guidelines.

#### **1.03 SUBMITTALS**

Submit under provisions of Section 01 33 00. Shop Drawings: Show the following: Dimensioned drawings including plans, elevations, and sections to show locker locations and interfaces with adjacent substrates. Details of assembly, erection, anchorage and clearance requirements. Selection Samples: For each finish product specified, two complete sets of color chips representing manufacturer's full range of available colors and finishes.

#### **1.04 DELIVERY, STORAGE AND HANDLING**

Store products in manufacturer's unopened packaging until ready for installation to protect the locker finish and adjacent surfaces from damage.

### **PART 2 - PRODUCTS**

#### **2.01 MANUFACTURER**

Acceptable Manufacturer: Penco Products, Inc., which is located at: 1820 Stonehenge Drive, Greenville, NC 27858; Tel: 800-562-1000; Fax: 800-248-1555; Email: general@pencoproducts.com; Web: www.pencoproducts.com .

Lockers shall be GREENGUARD Gold Certified by UL Environment through the GREENGUARD Certification Program.

#### **2.02 MATERIALS**

**Steel:** Prime grade mild cold-rolled sheet steel free from surface imperfection, capable of taking a high-grade enamel finish and in compliance with ASTM A1008. Sheet steel components shall be fabricated using zinc-coated steel free from surface imperfection, capable of taking a high-grade enamel finish and in compliance with ASTM A653. Flattened Expanded Metal Divisions that meets or exceeds ASTM A1008/A1008M, captured on all sides by the tubular shaped frame assembly. Self-Tapping Screws and Rivets. Provide only metal lockers that conform to Made in US regulations.

#### **2.03 HEAVY DUTY PERSONAL TA-50 LOCKERS**

**Heavy Duty Lockers:** All locker body components made of cold rolled steel specially formed for added strength and rigidity and to ensure tight joints at fastening points.

**Locker Body Construction:** Bottoms, Tops, and Shelves: 16-gauge steel. Sides: 16-gauge solid sides, Flattened expanded metal. Backs: Solid 18-gauge steel. One-piece. Doors: 14-gauge steel. Standard

Ventilation: 6-inch (152.4 mm) wide by 3/4" high (19.05 mm) high horizontal louvers arranged two groups of 6. Optional Ventilation: 3/4 inch (19 mm) wide by 1-1/2 inch (38 mm) high diamond-shaped perforations. Optional Ventilation: Solid. Tops and bottoms with four sides formed at 90 degrees welded to the fully-framed channel with cast corner pieces. Channel Base: 4-inch or 6-inch high. 14-gauge sheet forming a "C" channel attached to locker bottom. Shelves with four sides formed to 90 degrees, front and back edge having a second bend. Locker Body Construction: Tubular frame construction with cast steel interlocks provide a true fully framed locker body construction. Hole spacing in locker body construction: Not exceeding 3-inches. For factory assembly order Welded version.

**Doors:** One piece sheet steel with holes for attaching number plates.

**Hinges:** Continuous type: 16 gauge piano hinge measuring full height of door. Welded to door and attached to locker frame using steel rivets.

#### **2.04 DOOR HANDLES AND LATCHING**

**Single Tier Lockers:** Ultra Cremona Recessed Handle engages the door frame on three sides. The top and bottom frames are engaged with 0.375 inch (9.5 mm) steel rods, and a 0.25 x 0.36-inch-thick center latch engages at the side or left door. Locate handle in the formed stainless steel pocket. Double door configurations shall consist of a left hinged door secured its full length by the right hinged door when latched. Handle assembly shall be secured to the pocket using a guided channel. Pocket is secured to the door in two places. All door configurations delivered knocked down will have doors shipped separately for attachment on site using supplied hardware. Door shall be reinforced using a 20-gauge horizontal box pan MIG-welded a maximum of 8" on center to the hinge and latch side channels, and spot welded a maximum of 8" on center to the door skin along the upper and lower pan edge for optimum strength, quiet operation and stiffness. Firmly secure rubber silencers to locker frame.

**ADA Compliant:** Ultra Cremona Recessed Handle mechanism should be ADA complaint requiring no twisting, pinching or tight grasping and is operable using less than 5lbs of force.

#### **2.05 INTERIOR EQUIPMENT**

**Heavy Duty TA-50 Lockers with Doors:** Single Tier 78 inches (1981 mm): Shelf located approximately 13 inches (330 mm) below top of locker. Two heavy-duty single prong hooks with diameter of 0.276 inches mounted to shelf and will accept a coat rod. Two single prong hooks with a diameter of 0.187 inches in rear mounted to shelf.

### **2.06 ACCESSORIES**

(See full product specifications.)

### **2.07 FABRICATION**

Fabricate lockers with fully framed construction, 8 male/female tubular insertion points to provide the fully framed locker body, square, rigid, without warp, with metal faces flat and free of distortion. Fabricate lockers on the unit principle, each locker with individual door and frame, individual top, bottom, back, and shelves. Verify dimensions and arrangement before fabrication.

**Finish:** Enamel powder coat paint finish electrostatically applied and properly cured to manufacturer's specifications for optimum performance. Finishes containing volatile organic compounds and subject to out-gassing are not acceptable. Locker exterior and interior shall be painted the same color. Powder Coat - Dry Thickness: 1 to 1.2 mils (0.025 to 0.03 mm). Powder Coat Plus - Dry Thickness: 2 to 2.2 mils (0.05 to 0.055 mm). Color: As selected from manufacturer's standard colors.

**Special Finishes:** Custom color match, Anti-Graffiti, Anti-Microbial, and high performance finishes are available.

### **PART 3 - EXECUTION**

#### **3.01 EXAMINATION**

Do not begin installation until substrates and bases have been properly prepared. If substrate and bases are the responsibility of another installer, notify Architect of unsatisfactory preparation before proceeding.

#### **3.02 INSTALLATION**

Install metal lockers and accessories at locations shown in accordance with manufacturer's instructions. Install lockers plumb, level, and square. Work is not to progress until site meets necessary conditions. Anchor lockers to floor and/or wall as recommended by the manufacturer. Bolt adjoining locker units together to provide rigid installation. Install sloping tops and metal fillers using concealed fasteners. Provide flush hairline joints against adjacent surfaces. Install benches by fastening bench tops to pedestals and securely anchoring to the floor using appropriate anchors for the floor material.



## **PATRIOT** Fully Framed TA-50 Locker (Welded)

### PART 1 - GENERAL

#### 1.01 SECTION INCLUDES

Heavy Duty Welded TA-50 Lockers

#### 1.02 REFERENCES

ADAAG - Americans with Disabilities Act, Accessibility Guidelines.

#### 1.03 SUBMITTALS

Submit under provisions of Section 01 33 00. Shop Drawings shall show dimensioned plans, elevations, and sections.

#### 1.04 DELIVERY, STORAGE AND HANDLING

Store products in manufacturer's unopened packaging until ready for installation to protect the locker finish and adjacent surfaces from damage.

### PART 2 - PRODUCTS

#### 2.01 MANUFACTURER

Acceptable Manufacturer: Penco Products, Inc., which is located at: 1820 Stonehenge Drive, Greenville, NC 27858; Tel: 800-562-1000; Fax: 800-248-1555; Email: general@pencoproducts.com; Web: www.pencoproducts.com

Lockers shall be GREENGUARD Gold Certified by UL Environment through the GREENGUARD Certification Program.

#### 2.02 MATERIALS

**Steel:** Prime grade mild cold-rolled sheet steel free from surface imperfection, capable of taking a high-grade enamel finish and in compliance with ASTM A1008. Sheet steel components shall be fabricated using zinc-coated steel free from surface imperfection, capable of taking a high-grade enamel finish and in compliance with ASTM A653. Flattened Expanded Metal Divisions that meets or exceeds ASTM A1008/A1008M, captured on all sides by the tubular shaped frame assembly. Self-Tapping Screws and Rivets. Provide only metal lockers that conform to Made in US regulations.

#### 2.03 HEAVY DUTY PERSONAL TA-50 LOCKERS

**Heavy Duty Lockers:** All locker body components made of cold rolled steel specially formed for added strength and rigidity and to ensure tight joints at fastening points.

**Locker Body Construction:** Bottoms, Tops, and Shelves: 16-gauge steel. Sides: 16-gauge solid sides. Flattened Expanded Metal. Backs: Solid 18-gauge steel. One-piece. Doors: 14-gauge steel. Standard Ventilation: 6-inch (152.4 mm) wide by ¾" high (19.05 mm) high horizontal louvers arranged two groups of 6. Optional Ventilation: ¾ inch (19 mm) wide by 1-1/2 inch (38 mm) high diamond-shaped perforations. Optional Ventilation: Solid tops and bottoms with four sides formed

at 90 degrees welded to the fully- framed channel with cast corner pieces. Channel Base: 4-inch or 6-inch high. 14-gauge sheet forming a "C" channel attached to locker bottom. Shelves with four sides formed to 90 degrees, front and back edge having a second bend. Locker Body Construction: Tubular frame construction with cast steel interlocks provide a true fully framed locker body construction. Hole spacing in locker body construction: Not exceeding 3 inches. For factory assembly order Welded version.

**Locker Doors:** One-piece sheet steel. Provide holes for attaching number plates.

**Hinges:** Continuous type: 16 gauge piano hinge measuring full height of door. Welded to door and attached to locker frame using steel rivets.

#### 2.04 DOOR HANDLES AND LATCHING

**Single Tier Lockers:** Ultra Cremone Recessed Handle: Handle shall engage the door frame on three sides. The top and bottom frames are engaged with 0.375 inch (9.5 mm) steel rods, and a 0.25 x 0.36-inch-thick center latch engages at the side or left door. Locate handle in the formed stainless steel pocket. Double door configurations shall consist of a left hinged door secured its full length by the right hinged door when latched. Handle assembly shall be secured to the pocket using a guided channel. Pocket is secured to the door in two places. All door configurations delivered knocked down will have doors shipped separately for attachment on site using supplied hardware. Door shall be reinforced using a 20-gauge horizontal box pan MIG-welded a maximum of 8" on center to the hinge and latch side channels, and spot welded a maximum of 8" on center to the door skin along the upper and lower pan edge for optimum strength, quiet operation and stiffness. Firmly secure rubber silencers to locker frame.

**ADA Compliant:** Ultra Cremone Recessed Handle mechanism should be ADA complaint requiring no twisting,

pinching or tight grasping and is operable using less than 5lbs of force.

#### 2.05 INTERIOR EQUIPMENT

**A Heavy Duty TA-50 Lockers with Doors:** Single-Tier, 78-inches (1981 mm): Shelf located approximately 13-inches (330 mm) below top of locker. Coat Rod - using two heavy-duty single prong hooks, mounted to shelf and two single prong hooks with a diameter of 0.187 in rear, mounted to shelf.

#### 2.06 ACCESSORIES

(See full product specifications.)

#### 2.07 FABRICATION

Fabricate lockers with fully framed construction, 8 male/female tubular

insertion points to provide the fully framed locker body, square, rigid, without warp, with metal faces flat and free of distortion. Fabricate lockers on the unit principle, each locker with individual door and frame, individual top, bottom, back, and shelves. Verify dimensions and arrangement before fabrication.

**Finish:** Enamel powder coat paint finish electrostatically applied and properly cured to manufacturer's specifications for optimum performance. Finishes containing volatile organic compounds and subject to out-gassing are not acceptable. Locker exterior and interior shall be painted the same color. Powder Coat - Dry Thickness: 1 to 1.2 mils (0.025 to 0.03 mm). Powder Coat Plus - Dry Thickness: 2 to 2.2 mils (0.05 to 0.055 mm). Color: As selected from manufacturer's standard colors.

**Special Finishes:** Custom color match, Anti-Graffiti, Anti-Microbial, and high performance finishes are available.

### PART 3 - EXECUTION

#### 3.01 EXAMINATION

Do not begin installation until substrates and bases have been properly prepared. If substrate and bases are the responsibility of another installer, notify Architect of unsatisfactory preparation before proceeding.

#### 3.02 INSTALLATION

Install metal lockers and accessories at locations shown in accordance with manufacturer's instructions. Install lockers plumb, level, and square. Work is not to progress until site meets necessary conditions. Anchor lockers to floor and/or wall as recommended by the manufacturer. Bolt adjoining locker units together to provide rigid installation. Install sloping tops and metal fillers using concealed fasteners. Provide flush hairline joints against adjacent surfaces. Install benches by fastening bench tops to pedestals and securely anchoring to the floor using appropriate anchors for the floor material.

#### 3.03 ADJUSTING

Adjust doors and latches to operate without binding. Verify that latches are operating satisfactorily. Adjust built-in locks to prevent binding of dial or key and ensure smooth operation prior to substantial completion.

Touch-up with factory-supplied paint and repair or replace damaged products before substantial completion.

#### 3.04 PROTECTION

Protect installed products until completion of project.

## **PATRIOT**® Fully Framed Gear Locker (Knocked Down)

### PART 1 – GENERAL

#### 1.01 SECTION INCLUDES

Heavy Duty Knocked Down Fully Framed Gear Lockers

#### 1.02 REFERENCES

ADAAG - Americans with Disabilities Act, Accessibility Guidelines.

#### 1.03 SUBMITTALS

Submit under provisions of Section 01 33 00. Shop Drawings: Show the following: Dimensioned drawings including plans, elevations, and sections to show locker locations and interfaces with adjacent substrates. Details of assembly, erection, anchorage and clearance requirements. Selection Samples: For each finish product specified, two complete sets of color chips representing manufacturer's full range of available colors and finishes.

#### 1.04 DELIVERY, STORAGE AND HANDLING

Store products in manufacturer's unopened packaging until ready for installation to protect the locker finish and adjacent surfaces from damage.

### PART 2 – PRODUCTS

#### 2.01 MANUFACTURER

Acceptable Manufacturer: Penco Products, Inc., which is located at: 1820 Stonehenge Drive, Greenville, NC 27858; Tel: 800-562-1000; Fax: 800-248-1555; Email: general@pencoproducts.com; Web: www.pencoproducts.com

Lockers shall be GREENGUARD Gold Certified by UL Environment through the GREENGUARD Certification Program.

#### 2.02 MATERIALS

**Steel:** All Penco standard lockers are constructed using prime grade steel free from surface imperfection capable of taking high grade enamel finish. Sheet steel components shall be zinc coated and free from surface imperfection and capable of taking high grade enamel finish. Flattened expanded metal divisions meet or exceed ASTM M1008/A1008M captured on all sides by the tubular shaped frame assembly. Self-tapping screws and rivets. Provide only metal lockers that conform to Made in US regulations.

#### 2.03 HEAVY DUTY LOCKERS

**Heavy Duty Lockers:** All locker body components made of cold rolled steel specially formed for added strength and rigidity and to ensure tight joints at fastening points.

**Locker Body Construction:** Bottoms, Tops, and Shelves: 16-gauge steel. Sides: 16-gauge Solid Sides, Flattened expanded metal, 16-gauge Diamond Perforation on 72-inch high only. Backs: Solid 18-gauge steel. One-piece. Doors: 14-gauge steel. Standard Ventilation: 6-inch (152.4 mm) wide by 3/4" high (19.05 mm) high horizontal louvers arranged two groups of 6. Optional Ventilation: 3/4 inch (19 mm) wide by 1-1/2 inch (38 mm high diamond-shaped perforations. Optional Ventilation: Solid Tops and bottoms with four sides formed at 90 degrees welded to the fully-framed channel with cast corner pieces. Channel Base: 4-inch or 6-inch high. 14-gauge sheet forming a "C" channel attached to locker bottom. Shelves with four sides formed to 90 degrees, front and back edge having a second bend.

Tubular frame construction with cast steel interlocks provide a true fully framed locker body construction. Hole spacing in locker body construction: Not exceeding 3 inches.

**Locker Doors:** One-piece sheet steel. Provide holes for attaching number plates.

**Hinges:** Continuous type: 16-gauge piano hinge measuring full height of door. Welded to door and attached to locker frame using steel rivets.

#### 2.04 DOOR HANDLES AND LATCHING

**Single Tier Lockers:** Ultra Cremone Recessed Handle: Handle shall engage the door frame on three sides. The top and bottom frames are engaged with 3/8 inch (9.5 mm) steel rods, and a 1/4 x 3-inch-thick center latch engages at the side or left door. Locate handle in the formed stainless steel pocket. Double door configurations shall

consist of a left hinged door secured its full length by the right hinged door when latched. Handle assembly shall be secured to the pocket using a guided channel. Pocket is secured to the door in two places. Doors 18" wide or wider shall be reinforced using a 20-gauge vertical pan spot welded at a maximum of 8" on center to the hinge side of the door.

Door shall be reinforced using a 20-gauge horizontal box pan spot-welded a maximum of 8" on center to the hinge and latch side channels, and spot welded a maximum of 8" on center to the door skin along the upper and lower pan edge for optimum strength, quiet operation and stiffness. Firmly secure rubber silencers to locker frame.

## **PATRIOT** Fully Framed Gear Locker (Knocked Down)

**ADA Compliant:** Ultra Cremone Recessed Handle mechanism should be ADA complaint requiring no twisting, pinching or tight grasping and is operable using less than 5lbs of force.

### 2.05 INTERIOR EQUIPMENT

Heavy Duty Gear Lockers with Doors: Optional Full Width Shelf - located approximately 13-inches (330 mm) below top of locker. Optional Coat Rod - using two heavy duty single prong hooks, mounted to shelf and two single prong hooks with a diameter of 0.187 in rear, mounted to shelf.

### 2.06 ACCESSORIES

(See full product specifications.)

### 2.07 FABRICATION

Fabricate lockers with fully framed construction, 8 male/female tubular insertion points to provide the fully framed locker body, square, rigid, without warp, with metal faces flat and free of distortion. Fabricate lockers on the unit principle, each locker with individual door and frame, individual top, bottom, back, and shelves. Verify dimensions and arrangement before fabrication.

**Finish:** Enamel powder coat paint finish applied in strict adherence to paint manufacturer's specifications to provide optimum appearance and performance. Finishes releasing VOCs are not acceptable. Interior and Exterior shall be painted the same color. Standard coating thickness is 1 to 1.2 mil dry film thickness minimum. Powder Coat Plus option increases thickness to 2 to 2.2 mil minimum. Colors as selected from manufacturer's standard colors. All locker body components shall match color of door and frame.

**Special Finishes:** Custom color, Anti-Graffiti, and Anti-Microbial finishes are available.

## PART 3 – EXECUTION

### 3.01 EXAMINATION

Do not begin installation until substrates and bases have been properly prepared. If substrate and bases are the responsibility of another installer, notify Architect of unsatisfactory preparation before proceeding.

### 3.02 INSTALLATION

Install metal lockers and accessories at locations shown in accordance with manufacturer's instructions. Install lockers plumb, level, and square. Work is not to progress until site meets necessary conditions. Anchor lockers to floor and/or wall as recommended by the manufacturer. Bolt adjoining locker units together to provide rigid installation. Install sloping tops and metal fillers using concealed fasteners. Provide flush hairline joints against adjacent surfaces. Install benches by fastening bench tops to pedestals and securely anchoring to the floor using appropriate anchors for the floor material.

### 3.03 ADJUSTING AND CLEANING

Adjust doors and latches to operate without binding. Verify that latches are operating satisfactorily. Adjust built-in locks to prevent binding of dial or key and ensure smooth operation prior to substantial completion.

Touch-up with factory-supplied paint and repair or replace damaged products before substantial completion.

### 3.04 PROTECTION

Protect installed products until completion of project.

## **PATRIOT® Fully Framed Gear Locker (Welded)**

**ADA Compliant:** Ultra Cremona Recessed Handle mechanism should be ADA complaint requiring no twisting, pinching or tight grasping and is operable using less than 5lbs of force.

### **2.05 INTERIOR EQUIPMENT**

Heavy Duty Gear Lockers with Doors: Optional Full Width Shelf - located approximately 13-inches (330 mm) below top of locker. Optional Coat Rod - using two heavy duty single prong hooks, mounted to shelf and two single prong hooks with a diameter of 0.187 in rear, mounted to shelf.

### **2.06 ACCESSORIES**

(See full product specifications.)

### **2.07 FABRICATION**

Fabricate lockers with fully framed construction, 8 male/female tubular insertion points to provide the fully framed locker body, square, rigid, without warp, with metal faces flat and free of distortion. Fabricate lockers on the unit principle, each locker with individual door and frame, individual top, bottom, back, and shelves. Verify dimensions and arrangement before fabrication.

**Finish:** Enamel powder coat paint finish applied in strict adherence to paint manufacturer's specifications to provide optimum appearance and performance. Finishes releasing VOCs are not acceptable. Interior and Exterior shall be painted the same color. Standard coating thickness is 1 to 1.2 mil dry film thickness minimum. Powder Coat Plus option increases thickness to 2 to 2.2 mil minimum. Colors as selected from manufacturer's standard colors. All locker body components shall match color of door and frame.

**Special Finishes:** Custom color, Anti-Graffiti, and Anti-Microbial finishes are available.

## **PART 3 – EXECUTION**

### **3.01 EXAMINATION**

Do not begin installation until substrates and bases have been properly prepared. If substrate and bases are the responsibility of another installer, notify Architect of unsatisfactory preparation before proceeding.

### **3.02 INSTALLATION**

Install metal lockers and accessories at locations shown in accordance with manufacturer's instructions. Install lockers plumb, level, and square. Work is not to progress until site meets necessary conditions. Anchor lockers to floor and/or wall as recommended by the manufacturer. Bolt adjoining locker units together to provide rigid installation. Install sloping tops and metal fillers using concealed fasteners. Provide flush hairline joints against adjacent surfaces. Install benches by fastening bench tops to pedestals and securely anchoring to the floor using appropriate anchors for the floor material.

### **3.03 ADJUSTING AND CLEANING**

Adjust doors and latches to operate without binding. Verify that latches are operating satisfactorily. Adjust built-in locks to prevent binding of dial or key and ensure smooth operation prior to substantial completion.

Touch-up with factory-supplied paint and repair or replace damaged products before substantial completion.

### **3.04 PROTECTION**

Protect installed products until completion of project.

substantial completion.

### **3.04 PROTECTION**

Protect installed products until completion of project.

## **PATRIOT** Fully Framed Gear Locker (Welded)

### PART 1 – GENERAL

#### 1.01 SECTION INCLUDES

Heavy Duty Welded Fully Framed Gear Lockers

#### 1.02 REFERENCES

ADAAG - Americans with Disabilities Act, Accessibility Guidelines.

#### 1.03 SUBMITTALS

Submit under provisions of Section 01 33 00. Shop Drawings: Show the following: Dimensioned drawings including plans, elevations, and sections to show locker locations and interfaces with adjacent substrates. Details of assembly, erection, anchorage and clearance requirements. Selection Samples: For each finish product specified, two complete sets of color chips representing manufacturer's full range of available colors and finishes.

#### 1.04 DELIVERY, STORAGE AND HANDLING

Store products in manufacturer's unopened packaging until ready for installation to protect the locker finish and adjacent surfaces from damage.

### PART 2 – PRODUCTS

#### 2.01 MANUFACTURER

Acceptable Manufacturer: Penco Products, Inc., which is located at: 1820 Stonehenge Drive, Greenville, NC 27858; Tel: 800-562-1000; Fax: 800-248-1555; Email: general@pencoproducts.com; Web: www.pencoproducts.com

Lockers shall be GREENGUARD Gold Certified by UL Environment through the GREENGUARD Certification Program.

#### 2.02 MATERIALS

**Steel:** All Penco standard lockers are constructed using prime grade steel free from surface imperfection capable of taking high grade enamel finish. Sheet steel components shall be zinc coated and free from surface imperfection and capable of taking high grade enamel finish. flattened expanded metal divisions meet or exceed ASTM M1008/A1008M captured on all sides by the tubular

shaped frame assembly. Self-tapping screws and rivets. Provide only metal lockers that conform to Made in US regulations.

#### 2.03 HEAVY DUTY LOCKERS

**Heavy Duty Lockers:** All locker body components made of cold rolled steel specially formed for added strength and rigidity and to ensure tight joints at fastening points.

**Locker Body Construction:** Bottoms, Tops, and Shelves: 16-gauge steel. Sides: 16-gauge Solid Sides, Flattened expanded metal, 16-gauge Diamond Perforation on 72-inch high only. Backs: Solid 18-gauge steel. One-piece. Doors: 14-gauge steel. Standard Ventilation: 6-inch (152.4 mm) wide by  $\frac{3}{4}$ " high (19.05 mm) high horizontal louvers arranged two groups of 6. Optional Ventilation:  $\frac{3}{4}$  inch (19 mm) wide by 1-1/2 inch (38 mm high diamond-shaped perforations. Optional Ventilation: Solid Tops and bottoms with four sides formed at 90 degrees welded to the fully- framed channel with cast corner pieces. Channel Base: 4-inch or 6-inch high. 14-gauge sheet forming a "C" channel attached to locker bottom. Shelves with four sides formed to 90 degrees, front and back edge having a second bend.

Welded shell. Tubular frame construction with cast steel interlocks provide a true fully framed locker body construction. Hole spacing in locker body construction: Not exceeding 3 inches.

**Locker Doors:** One-piece sheet steel. Provide holes for attaching number plates.

**Hinges:** Continuous type: 16-gauge piano hinge measuring full height of door. Welded to door and attached to locker frame using steel rivets.

#### 2.04 DOOR HANDLES AND LATCHING

**Single Tier Lockers:** Ultra Cremone Recessed Handle: Handle shall engage the door frame on three sides. The top and bottom frames are engaged with  $\frac{3}{8}$  inch (9.5 mm) steel rods, and a  $\frac{1}{4}$  x 3-inch-thick center latch engages at the

side or left door. Locate handle in the formed stainless steel pocket. Double door configurations shall consist of a left hinged door secured its full length by the right hinged door when latched. Handle assembly shall be secured to the pocket using a guided channel. Pocket is secured to the door in two places. Doors 18" wide or wider shall be reinforced using a 20-gauge vertical pan spot welded at a maximum of 8" on center to the hinge side of the door.

Door shall be reinforced using a 20-gauge horizontal box pan spot-welded a maximum of 8" on center to the hinge and latch side channels, and spot welded a maximum of 8" on center to the door skin along the upper and lower pan edge for optimum strength, quiet operation and stiffness. Firmly secure rubber silencers to locker frame.

# Specifications

pencoproducts.com | 800.562.1000

## **PATRIOT® Fully Framed Turnout Locker (Knocked Down)**

### PART 1 – GENERAL

#### 1.01 SECTION INCLUDES

Heavy Duty Knocked Down Fully Framed Turnout Open Front Lockers

#### 1.02 REFERENCES

ADAAG - Americans with Disabilities Act, Accessibility Guidelines.

#### 1.03 SUBMITTALS

Submit under provisions of Section 01 33 00. Shop Drawings shall show dimensioned plans, elevations, and sections. For each product specified, two complete sets of color chips representing manufacturer's full range of available colors and finishes.

#### 1.04 DELIVERY, STORAGE AND HANDLING

Store products in manufacturer's unopened packaging until ready for installation to protect the locker finish and adjacent surfaces from damage.

### PART 2 – PRODUCTS

#### 2.01 MANUFACTURER

Acceptable Manufacturer: Penco Products, Inc., which is located at: 1820 Stonehenge Drive, Greenville, NC 27858; Tel: 800-562-1000; Fax: 800-248-1555; Email: general@pencoproducts.com; Web: www.pencoproducts.com

Lockers shall be GREENGUARD Gold Certified by UL Environment through the GREENGUARD Certification Program.

#### 2.02 MATERIALS

**Steel:** Prime grade mild cold-rolled sheet steel free from surface imperfection, capable of taking a high-grade enamel finish and in compliance with ASTM A1008. Steel: Sheet steel components shall be fabricated using zinc-coated steel free from surface imperfection, capable of taking a high-grade enamel finish and in compliance with ASTM A653. Flattened Expanded Metal Divisions that meets or exceeds ASTM A1008/A1008M, captured on all sides by the tubular shaped frame assembly. Self-Tapping Screws and Rivets. Provide only metal lockers that conform to Made in US regulations.

#### 2.03 HEAVY DUTY OPEN FRONT PERSONAL EQUIPMENT LOCKERS

**Heavy Duty Lockers:** All locker body components made of cold rolled steel specially formed for added strength and rigidity and to ensure tight joints at fastening points.

**Locker Body Construction:** Bottoms, Tops and Shelves made from 16-gauge steel. Sides shall be either 16-gauge solid, flattened expanded metal, or 16-gauge diamond perforation (on 72 inch high only). Backs shall be solid 18-gauge single piece. Tops and bottoms with four sides formed at 90 degrees welded to the fully-framed channel with cast corner pieces. Channel Base shall be 4 inch or 6 inch high from 14-gauge sheet forming "C" channel attached to locker bottom. Shelves with four sides formed to 90 degrees, front edge having a second bend. Tubular frame construction with cast steel interlocks to provide a true fully framed locker body construction. Hole spacing in body not to exceed 3 inches. Optional factory assembly of

lockers (welded version only).

#### 2.04 INTERIOR EQUIPMENT

**Heavy Duty Fully Framed Turnout Lockers Without Doors:** Optional Full Width Shelf - located approximately 13-inches (330 mm) below top of locker. Optional Coat Rod - using two heavy duty single prong hooks, mounted to shelf and two single prong hooks with a diameter of 0.187 in rear, mounted to shelf.

#### 2.05 ACCESSORIES

(For Full Line of Accessories see Complete Specifications Online)

**Interior Equipment:** Optional Acrylic Mirror: Self-Adhesive, 6-inch (152 mm) x 8 inch (203 mm). Optional Full Width Shelves: 16-gauge, flanged on four sides and attached securely to mounting side rails. Optional Center Partition: 16-gauge with flanged front. Attaches securely to shelf and locker bottom or additional lower shelf. (Not for use with footlocker or seat) Mounting holes for half shelves provided on nominal 6 inch centers.

4. Optional Half Shelf: 16-gauge, used with full height center partition only. Flanged on three sides. Optional "L" Shaped Half Shelves: 16-gauge, flanged on three sides and attached securely on one side with a side rail, and flanged partition mounted to shelf or half shelf above. Optional Security box: 16-gauge lockable door with a 16-gauge side panel. The door is attached to the welded frame of the security using a two-point hinge. The door is locked through a single point latch with a padlock or built-in lock. A door pull shall be provided for use with padlocks. Security box door frame to be not less than 16 gauge formed to a channel shape. Vertical members to have an additional flange to provide a continuous door strike. 9-inch wide, 12-inch wide, 15-inch wide, 18-inch wide, 21-inch wide, 24-inch wide. Optional cell phone/key tray: 8-inch (203 mm) x 2-inch (51 mm) x 2-inch (51 mm) mounted to flanged partition side of the half shelf. Optional metal seat only: 14-gauge, mounted using mounting rails to vertical corner posts allowing adjustability. Optional hardwood seat only: 1-1/4" thick full depth mounted using mounting rails to vertical corner posts allowing adjustability. Optional footlocker: Recessed from locker frame to clear full length locker door. Front foot locker panel includes single point latch with padlock strike plate and vertical slots. 14-gauge lid of footlocker has a continuous hinge and. Also serves as a seat. Opening and closing of the lid is quieted by rubber bumpers mounted to the contact points. The seat lid is strengthened with reinforcement channels welded to bottom. Lid/seat is supported by two mounting side rails attached to the vertical posts. Optional sheet steel document sleeve. 16-gauge measuring 12-inches wide (horizontal storage) or 9-1/2 inches wide (vertical storage) mounted to flanged partition side of the half shelf. Optional Drawers. 12-inch-high or 6-inch high. Drawer body shall be constructed of 16-gauge sheet steel, mounted using an integral "C" channel

and mounted to the side rails that are mounted to the corner posts. Optional Parachute/body armor rack. Formed from 3/4 inch diameter, heavy wall steel tube. Reinforced by 14-gauge gussets. Mounted to rear of locker using two mounting rails between corner posts. 180-pound capacity. Optional Inner Compartment Door, attached to "L" shaped half shelf. Optional Coat Rods using coat rod hooks mounted to shelf.

#### 2.06 FABRICATION

Fabricate lockers with fully framed construction, 8 male/female tubular insertion points to provide the fully framed locker body, square, rigid, without warp, with metal faces flat and free of distortion. Fabricate lockers on the unit principle, each locker with individual door and frame, individual top, bottom, back, and shelves. Verify dimensions and arrangement before fabrication.

**Finish:** Enamel powder coat paint finish electrostatically applied and properly cured to manufacturer's specifications for optimum performance. Finishes releasing VOC's and subject to out-gassing are not acceptable. Locker exterior and interior shall be painted the same color. Standard coating thickness is 1 to 1.2 mils (0.025 to 0.03 mm) dry film thickness minimum. Powder Coat Plus option is 2 to 2.2 mils (.05 to .055 mm). Colors as selected from manufacturer's standard colors.

**Alternative finishes:** Custom color match, Anti-Graffiti or Anti-Microbial finishes are available.

### PART 3 – EXECUTION

#### 3.01 EXAMINATION

Do not begin installation until substrates and bases have been properly prepared. If substrate and bases are the responsibility of another installer, notify Architect of unsatisfactory preparation before proceeding.

#### 3.02 INSTALLATION

Install metal lockers and accessories at locations shown in accordance with manufacturer's instructions. Install lockers plumb, level, and square. Work is not to progress until site meets necessary conditions. Anchor lockers to floor and/or wall as recommended by the manufacturer. Bolt adjoining locker units together to provide rigid installation. Install sloping tops and metal fillers using concealed fasteners. Provide flush hairline joints against adjacent surfaces. Install benches by fastening bench tops to pedestals and securely anchoring to the floor using appropriate anchors for the floor material.

#### 3.03 ADJUSTING

Adjust doors and latches to operate without binding. Verify that latches are operating satisfactorily. Adjust built-in locks to prevent binding of dial or key and ensure smooth operation prior to substantial completion. Touch-up with factory-supplied paint and repair or replace damaged products before substantial completion.

#### 3.04 PROTECTION

Protect installed products until completion of project.

## **PATRIOT® Fully Framed Turnout Locker (Welded)**

### **PART 1 – GENERAL**

#### **1.01 SECTION INCLUDES**

Heavy Duty Welded Fully Framed Turnout Open Front Lockers

#### **1.02 REFERENCES**

ADAAG - Americans with Disabilities Act, Accessibility Guidelines.

#### **1.03 SUBMITTALS**

Submit under provisions of Section 01 33 00. Shop Drawings shall show dimensioned plans, elevations, and sections. For each product specified, two complete sets of color chips representing manufacturer's full range of available colors and finishes.

#### **1.04 DELIVERY, STORAGE AND HANDLING**

Store products in manufacturer's unopened packaging until ready for installation to protect the locker finish and adjacent surfaces from damage.

### **PART 2 – PRODUCTS**

#### **2.01 MANUFACTURER**

Acceptable Manufacturer: Penco Products, Inc., which is located at: 1820 Stonehenge Drive, Greenville, NC 27858; Tel: 800-562-1000; Fax: 800-248-1555; Email: general@pencoproducts.com; Web: www.pencoproducts.com. Lockers shall be GREENGUARD Gold Certified by UL Environment through the GREENGUARD Certification Program.

#### **2.02 MATERIALS**

**Steel:** Prime grade mild cold-rolled sheet steel free from surface imperfection, capable of taking a high-grade enamel finish and in compliance with ASTM A1008. Steel: Sheet steel components shall be fabricated using zinc-coated steel free from surface imperfection, capable of taking a high-grade enamel finish and in compliance with ASTM A653. Flattened Expanded Metal Divisions that meets or exceeds ASTM A1008/A1008M, captured on all sides by the tubular shaped frame assembly. Self-Tapping Screws and Rivets. Provide only metal lockers that conform to Made in US regulations.

#### **2.03 HEAVY DUTY OPEN FRONT PERSONAL EQUIPMENT LOCKERS**

**Heavy Duty Lockers:** All locker body components made of cold rolled steel specially formed for added strength and rigidity and to ensure tight joints at fastening points.

**Locker Body Construction:** Bottoms, Tops and Shelves made from 16-gauge steel. Sides shall be either 16-gauge solid, Flattened Expanded Metal, or 16-gauge diamond perforation (on 72 inch high only). Backs shall be solid 18-gauge single piece. Tops and bottoms with four sides formed at 90 degrees welded to the fully-framed channel with cast corner pieces. Channel Base shall be 4 inch or 6 inch high form 14-gauge sheet forming "C" channel attached to locker bottom. Shelves with four sides formed to 90 degrees, front edge having a second bend. Tubular frame construction with cast steel interlocks to provide a true fully framed locker body construction. Hole spacing in body not to

exceed 3 inches. Optional factory assembly of lockers (welded version only).

#### **2.04 INTERIOR EQUIPMENT**

**Heavy Duty Fully Framed Turnout Lockers Without Doors:** Optional Full Width Shelf - located approximately 13-inches (330 mm) below top of locker. Optional Coat Rod - using two heavy duty single prong hooks, mounted to shelf and two single prong hooks with a diameter of 0.187 in rear, mounted to shelf.

#### **2.05 ACCESSORIES**

(For Full Line of Accessories see Complete Specifications Online)

**Interior Equipment:** Optional Acrylic Mirror: Self-Adhesive, 6-inch (152 mm) x 8 inch (203 mm). Optional Full Width Shelves: 16-gauge, flanged on four sides and attached securely to mounting side rails. Optional Center Partition: 16-gauge with flanged front. Attaches securely to shelf and locker bottom or additional lower shelf. (Not for use with footlocker or seat) Mounting holes for half shelves provided on nominal 6 inch centers.

4. Optional Half Shelf: 16-gauge, used with full height center partition only. Flanged on three sides. Optional "L" Shaped Half Shelves: 16-gauge, flanged on three sides and attached securely on one side with a side rail, and flanged partition mounted to shelf or half shelf above. Optional Security box: 16-gauge lockable door with a 16-gauge side panel. The door is attached to the welded frame of the security using a two-point hinge. The door is locked through a single point latch with a padlock or built-in lock. A door pull shall be provided for use with padlocks. Security box door frame to be not less than 16 gauge formed to a channel shape. Vertical members to have an additional flange to provide a continuous door strike. 9-inch wide, 12-inch wide, 15-inch wide, 18-inch wide, 21-inch wide, 24-inch wide. Optional cell phone/key tray: 8-inch (203 mm) x 2-inch (51 mm) x 2-inch (51 mm) mounted to flanged partition side of the half shelf. Optional metal seat only: 14-gauge, mounted using mounting rails to vertical corner posts allowing adjustability. Optional hardwood seat only: 1-1/4" thick full depth mounted using mounting rails to vertical corner posts allowing adjustability. Optional footlocker: Recessed from locker frame to clear full length locker door. Front foot locker panel includes single point latch with padlock strike plate and vertical slots. 14-gauge lid of footlocker has a continuous hinge and. Also serves as a seat. Opening and closing of the lid is quieted by rubber bumpers mounted to the contact points. The seat lid is strengthened with reinforcement channels welded to bottom. Lid/seat is supported by two mounting side rails attached to the vertical posts. Optional sheet steel document sleeve. 16-gauge measuring 12-inches wide (horizontal storage) or 9-1/2 inches wide (vertical storage) mounted to flanged partition side of the half shelf. Optional Drawers. 12-inch-high or 6-inch high. Drawer body shall be constructed of 16-gauge sheet

steel, mounted using an integral "C" channel and mounted to the side rails that are mounted to the corner posts. Optional Parachute/body armor rack. Formed from 3/4 inch diameter, heavy wall steel tube. Reinforced by 14-gauge gussets. Mounted to rear of locker using two mounting rails between corner posts. 180-pound capacity. Optional Inner Compartment Door, attached to "L" shaped half shelf. Optional Coat Rods using coat rod hooks mounted to shelf.

#### **2.06 FABRICATION**

Fabricate lockers with fully framed construction, 8 male/female tubular insertion points to provide the fully framed locker body, square, rigid, without warp, with metal faces flat and free of distortion.

Fabricate lockers on the unit principle, each locker with individual door and frame, individual top, bottom, back, and shelves. Verify dimensions and arrangement before fabrication.

**Finish:** Enamel powder coat paint finish electrostatically applied and properly cured to manufacturer's specifications for optimum performance. Finishes releasing VOC's and subject to out-gassing are not acceptable. Locker exterior and interior shall be painted the same color. Standard coating thickness is 1 to 1.2 mils (0.025 to 0.03 mm) dry film thickness minimum. Powder Coat Plus option is 2 to 2.2 mils (.05 to .055 mm). Colors as selected from manufacturer's standard colors.

**Alternative finishes:** Custom color match, Anti-Graffiti or Anti-Microbial finishes are available.

### **PART 3 – EXECUTION**

#### **3.01 EXAMINATION**

Do not begin installation until substrates and bases have been properly prepared. If substrate and bases are the responsibility of another installer, notify Architect of unsatisfactory preparation before proceeding.

#### **3.02 INSTALLATION**

Install metal lockers and accessories at locations shown in accordance with manufacturer's instructions. Install lockers plumb, level, and square. Work is not to progress until site meets necessary conditions. Anchor lockers to floor and/or wall as recommended by the manufacturer. Bolt adjoining locker units together to provide rigid installation. Install sloping tops and metal fillers using concealed fasteners. Provide flush hairline joints against adjacent surfaces. Install benches by fastening bench tops to pedestals and securely anchoring to the floor using appropriate anchors for the floor material.

#### **3.03 ADJUSTING**

Adjust doors and latches to operate without binding. Verify that latches are operating satisfactorily. Adjust built-in locks to prevent binding of dial or key and ensure smooth operation prior to substantial completion. Touch-up with factory-supplied paint and repair or replace damaged products before substantial completion.

#### **3.04 PROTECTION**

Protect installed products until completion of project.

## **PATRIOT** Fully Framed Duty Locker (Knocked Down)

### PART 1 – GENERAL

#### 1.01 SECTION INCLUDES

Heavy Duty Knocked Down Fully Framed Duty Lockers

#### 1.02 REFERENCES

ADAAG - Americans with Disabilities Act, Accessibility Guidelines.

#### 1.03 SUBMITTALS

Submit under provisions of Section 01 33 00. Shop Drawings shall show dimensioned plans, elevations, sections, details of assembly, erection anchorage and clearance requirements. For each product specified, two complete sets of color chips representing manufacturer's full range of colors for selection are available.

#### 1.04 DELIVERY, STORAGE AND HANDLING

Store products in manufacturer's unopened packaging until ready for installation to protect the locker finish and adjacent surfaces from damage.

### PART 2 – PRODUCTS

#### 2.01 MANUFACTURER

Acceptable Manufacturer: Penco Products, Inc., which is located at: 1820 Stonehenge Drive, Greenville, NC 27858; Tel: 800-562-1000; Fax: 800-248-1555; Email: general@pencoproducts.com; Web: www.pencoproducts.com.

Lockers shall be GREENGUARD Gold Certified by UL Environment through the GREENGUARD Certification Program.

#### 2.02 MATERIALS

**Steel:** All Penco standard lockers are constructed using prime grade steel free from surface imperfection capable of taking high grade enamel finish. Sheet steel components shall be zinc coated and free from surface imperfection and capable of taking high grade enamel finish. Self-tapping screws and rivets. Provide only metal lockers that conform to Made in US regulations.

#### 2.03 HEAVY DUTY LOCKERS

**Heavy Duty Lockers:** All locker body components made of cold rolled steel specially formed for added strength and rigidity and to ensure tight joints at fastening points.

**Locker Body:** Bottoms, Tops, and Shelves: 16-gauge steel. Sides: 16-gauge solid sides Backs: Solid 18-gauge steel. One-piece. Doors: 14-gauge steel. Standard Ventilation: 6-inch (152.4 mm) wide by 3/4" high (19.05 mm) high horizontal louvers arranged two groups of 6. Optional Ventilation: 3/4 inch (19 mm) wide by 1-1/2 inch (38 mm) high diamond-shaped perforations. Optional Ventilation: Solid tops and bottoms with four sides formed at 90 degrees welded to the fully-framed channel with cast corner pieces. Shelves with four sides formed to 90 degrees, front and back edge having a second bend. Locker Body Construction: Tubular frame construction with cast steel interlocks provide a true fully framed locker body construction. Hole spacing in locker body construction: Not exceeding 3 inches. Optional factory assembly of lockers (welded version only).

**Locker Doors:** One piece sheet steel. Provide holes for number plates.

**Hinges:** Continuous type 16 gauge hinge measuring full height of door. Welded to door and attached to locker frame using steel rivets.

**Duty Locker Drawer Base with Integral Seat:** 78-inch-high Duty lockers provide a 78-inches high locker with a 9-inch or 12-inch front extension to create the drawer base. 90-inch-high Duty lockers, provide a 90-inches high locker with a 9-inch or 12-inch front extension to create the drawer base. 16-gauge drawer body, rated at 250 pounds per pair. Drawer face with integral finger grab and punched to accept built-in spring bolt locker lock, key lock or padlock. **Hardwood seat:** Laminated selected hardwood, 1-1/4 inch (31.75 mm) full finished thickness, corners rounded and sanded, surfaces finished with two coats of clear lacquer. Depth: 9-1/2 inches (241.3 mm) or 12-inches (304.8 mm) depending on front extension size. Length: As shown, continuous along adjoining lockers with drawer bases or individual benches for each unit.

#### 2.04 DOOR HANDLES AND LATCHING

**Single Tier Lockers:** Ultra Cremone Recessed Handle: Handle shall be a die

cast lift handle that engages the door frame on three sides. The top and bottom frames are engaged with 3/8 inch (9.5 mm) steel rods, and a 1/4 x 3-inch-thick center latch engages at the side or left door. Locate handle in the formed stainless steel pocket. Double door configurations shall consist of a left hinged door secured its full length by the right hinged door when latched. Handle assembly shall be secured to the pocket using a guided channel. Pocket is secured to the door in two places. Doors 18" wide or wider shall be reinforced using a 20-gauge vertical pan spot welded at a maximum of 8" on center to the hinge side of the door. Door shall be reinforced using a 20-gauge horizontal box pan spot-welded a maximum of 8" on center to the hinge and latch side channels, and spot welded a maximum of 8" on center to the door skin along the upper and lower pan edge for optimum strength, quiet operation and stiffness. Firmly secure rubber silencers to locker frame.



**ADA Compliant:** Ultra Cremone Recessed Handle mechanism shall be ADA complaint requiring no twisting, pinching or tight grasping and is operable using less than 5lbs of force.

### 2.05 INTERIOR EQUIPMENT

#### Heavy Duty Lockers With Doors:

Optional Full Width Shelf - located approximately 13-inches (330 mm) below top of locker. Optional Coat Rod – using two heavy duty single prong hooks, mounted to shelf and two single prong hooks with a diameter of 0.187 in rear, mounted to shelf.

### 06 ACCESSORIES

(See full product specifications.)

### 2.07 FABRICATION

Fabricate lockers with fully framed construction, 8 male/female tubular insertion points to provide the fully framed locker body, square, rigid, without warp, with metal faces flat and free of distortion. Fabricate lockers on the unit principle, each locker with individual door and frame, individual top, bottom, back, and shelves. Verify dimensions and arrangement before fabrication.

**Finish:** Enamel powder coat paint finish electrostatically applied and properly cured to manufacturer's specifications for optimum performance. Finishes containing volatile organic compounds and subject to out-gassing are not acceptable. Locker exterior and interior shall be painted the same color.

**Alternative finishes:** Custom color, Anti- Graffiti, and Anti-Microbial finishes are available.

## PART 3 – EXECUTION

### 3.01 EXAMINATION

Do not begin installation until substrates and bases have been properly prepared. If substrate and bases are the responsibility of another installer, notify Architect of unsatisfactory preparation before proceeding.

### 3.02 INSTALLATION

Install metal lockers and accessories at locations shown in accordance with manufacturer's instructions. Install lockers plumb, level, and square. Work is not to progress until site meets necessary conditions. Anchor lockers to floor and/or wall as recommended by the manufacturer. Bolt adjoining locker units together to provide rigid installation. Install sloping tops and metal fillers using concealed fasteners. Provide flush hairline joints against adjacent surfaces. Install benches by fastening bench tops to pedestals and securely anchoring to the floor using appropriate anchors for the floor material.

### 3.03 ADJUSTING AND CLEANING

Adjust doors and latches to operate without binding. Verify that latches are operating satisfactorily. Adjust built-in locks to prevent binding of dial or key and ensure smooth operation prior to substantial completion. Touch-up with factory-supplied paint and repair or replace damaged products before substantial completion.

### 3.04 PROTECTION

Protect installed products until completion of project.

## **PATRIOT** Fully Framed Duty Locker (Welded)

### PART 1 – GENERAL

#### 1.01 SECTION INCLUDES

Heavy Duty Welded Fully Framed Duty Lockers

#### 1.02 REFERENCES

ADAAG - Americans with Disabilities Act, Accessibility Guidelines.

#### 1.03 SUBMITTALS

Submit under provisions of Section 01 33 00. Shop Drawings shall show dimensioned plans, elevations, sections, details of assembly, erection anchorage and clearance requirements. For each product specified, two complete sets of color chips representing manufacturer's full range of colors for selection are available.

#### 1.04 DELIVERY, STORAGE AND HANDLING

Store products in manufacturer's unopened packaging until ready for installation to protect the locker finish and adjacent surfaces from damage.

### PART 2 – PRODUCTS

#### 2.01 MANUFACTURER

Acceptable Manufacturer is Penco Products, Inc. located at 1820 Stonehenge Dr., Greenville, NC 27858.

Lockers shall be GREENGUARD Gold Certified by UL Environment through the GREENGUARD Certification Program.

#### 2.02 MATERIALS

**Steel:** All Prime grade mild cold-rolled sheet steel free from surface imperfection, capable of taking a high-grade enamel finish and in compliance with ASTM A1008. Sheet steel components shall be fabricated using zinc-coated steel free from surface imperfection, capable of taking a high-grade enamel finish and in compliance with ASTM A653. Self-Tapping Screws and Rivets. Provide only metal lockers that conform to Made in US regulations.

#### 2.03 HEAVY-DUTY PERSONAL DUTY LOCKERS

**Heavy Duty Lockers:** All locker body components made of cold rolled steel specially formed for added strength and rigidity and to ensure tight joints at fastening points.

**Locker Body Construction:** Welded shell. Bottoms, Tops, and Shelves: 16-gauge steel. Sides: 16-gauge solid sides. Backs: Solid 18-gauge steel. One-piece. Doors: 14-gauge steel. Standard Ventilation: 6-inch (152.4 mm) wide by ¾" high (19.05 mm) high horizontal louvers arranged two groups of 6. Optional Ventilation: ¾ inch (19 mm) wide by 1-1/2 inch (38 mm) high diamond-shaped perforations. Optional Ventilation: Solid tops and bottoms with four sides formed at 90 degrees welded to the fully- framed channel with cast corner pieces. Shelves with four sides formed to 90 degrees, front and back edge having a second bend. **Locker Body Construction:** Welded shell. Tubular frame construction with cast steel interlocks provide a true fully framed locker body construction. Hole spacing in locker body construction: Not exceeding 3 inches.

**Locker Doors:** One piece sheet steel. Provide holes for number plates.

**Hinges:** Continuous type: 16 gauge hinge measuring full height of door. Welded to door and attached to locker frame using steel rivets.

#### Duty Locker Drawer Base with Integral

**Seat:** 78-inch high Duty lockers, provide a 78-inch high locker with a 9-inch or 12-inch front extension to create the drawer base. 90-inch high Duty lockers, provide a 90-inch high locker with a 9-inch or 12-inch front extension to create the drawer base. 16-gauge drawer body, rated at 250 pounds per pair. Drawer face with integral finger grab and punched to accept built-in spring bolt locker lock, key lock or padlock. **Hardwood seat:** Laminated selected hardwood, 1-1/4 inch (31.75 mm) full finished thickness, corners rounded and sanded, surfaces finished with two coats of clear lacquer. Depth: 9-1/2 inches (241.3 mm) or 12-inches (304.8 mm) depending on front extension size. Length: As shown, continuous along adjoining lockers with drawer bases or individual benches for each unit.

#### 2.04 DOOR HANDLES AND LATCHING

**Single Tier Lockers:** Ultra Cremone Recessed Handle: Handle shall be a die cast lift handle that engages the door frame on three sides. The top and

bottom frames are engaged with 3/8 inch (9.5 mm) steel rods, and a ¼ x 3-inch-thick center latch engages at the side or left door. Locate handle in the formed stainless steel pocket. Double door configurations shall consist of a left hinged door secured its full length by the right hinged door when latched. Handle assembly shall be secured to the pocket using a guided channel. Pocket is secured to the door in two places. Doors 18" wide or wider shall be reinforced using a 20-gauge vertical pan spot welded at a maximum of 8" on center to the hinge side of the door. Door shall be reinforced using a 20-gauge horizontal box pan spot-welded a maximum of 8" on center to the hinge and latch side channels, and spot welded a maximum of 8" on center to the door skin along the upper and lower pan edge for optimum strength, quiet operation and stiffness. Firmly secure rubber silencers to locker frame.

## **PATRIOT** Fully Framed Duty Locker (Welded)

**ADA Compliant:** Ultra Cremona Recessed Handle mechanism shall be ADA complaint requiring no twisting, pinching or tight grasping and is operable using less than 5lbs of force.

### **2.05 INTERIOR EQUIPMENT** **Heavy Duty Duty Lockers with Doors:**

Optional Full Width Shelf - located approximately 13-inches (330 mm) below top of locker. Optional Coat Rod – using two heavy duty single prong hooks, mounted to shelf and two single prong hooks with a diameter of 0.187 in rear, mounted to shelf.

### **2.06 ACCESSORIES** (See full product specifications.)

**2.07 FABRICATION**  
Fabricate lockers with fully framed construction, 8 male/female tubular insertion points to provide the fully framed locker body, square, rigid, without warp, with metal faces flat and free of distortion. Fabricate lockers on the unit principle, each locker with individual door and frame, individual top, bottom, back, and shelves. Verify dimensions and arrangement before fabrication.

**Finish:** Enamel powder coat paint finish electrostatically applied and properly cured to manufacturer's specifications for optimum performance. Finishes containing volatile organic compounds and subject to out-gassing are not acceptable. Locker exterior and interior shall be painted the same color. Powder Coat - Dry Thickness: 1 to 1.2 mils (0.025 to 0.03 mm). Powder Coat Plus - Dry Thickness: 2 to 2.2 mils (0.05 to 0.055 mm). Color: As selected from manufacturer's standard colors.

**Special Finishes:** Custom color, Anti-Graffiti, and Anti-Microbial finishes are available.

## **PART 3 – EXECUTION**

### **3.01 EXAMINATION**

Do not begin installation until substrates and bases have been properly prepared. If substrate and bases are the responsibility of another installer, notify Architect of unsatisfactory preparation before proceeding.

### **3.02 INSTALLATION**

Install metal lockers and accessories at locations shown in accordance with manufacturer's instructions. Install lockers plumb, level, and square. Work is not to progress until site meets necessary conditions. Anchor lockers to floor and/or wall as recommended by the manufacturer. Bolt adjoining locker units together to provide rigid installation. Install sloping tops and metal fillers using concealed fasteners. Provide flush hairline joints against adjacent surfaces. Install benches by fastening bench tops to pedestals and securely anchoring to the floor using appropriate anchors for the floor material.

### **3.03 ADJUSTING AND CLEANING**

Adjust doors and latches to operate without binding. Verify that latches are operating satisfactorily. Adjust built-in locks to prevent binding of dial or key and ensure smooth operation prior to substantial completion.

Touch-up with factory-supplied paint and repair or replace damaged products before substantial completion.

### **3.04 PROTECTION**

Protect installed products until completion of project.

## **PATRIOT® Fully Framed Lockers Accessories**

### **PART 1 – GENERAL**

#### **1.01 SECTION INCLUDES**

Accessories for Metal Lockers

#### **1.02 REFERENCES**

ADAAG - Americans with Disabilities Act, Accessibility Guidelines.

#### **1.03 SUBMITTALS**

Submit under provisions of Section 01 33 00. Shop Drawings shall show dimensioned plans, elevations, and sections.

#### **1.04 DELIVERY, STORAGE AND HANDLING**

Store products in manufacturer's unopened packaging until ready for installation to protect the locker finish and adjacent surfaces from damage.

### **PART 2 – PRODUCTS**

#### **2.01 MANUFACTURER**

Penco Products, Inc. or approved equal based upon ability to provide product compliant with specifications of the product selected. Provide only metal lockers that conform to Made in US regulations.

Lockers shall be GREENGUARD Gold Certified by UL Environment through the GREENGUARD Certification Program.

#### **2.02 MATERIALS**

**Steel:** All Penco standard accessories are constructed using prime grade mild cold-rolled sheet steel free from surface imperfection meeting ASTM A1008 and capable of taking a high-grade enamel powder coat finish. Alternate material: Sheet steel components shall be fabricated using zinc-coated steel meeting ASTM A653 and finished in the same manner.

#### **2.03 ACCESSORIES**

**Number Plates:** Provide each locker with a polished aluminum number plate, 2-1/4 inches (57 mm) wide by 1 inch (25 mm) high, with black numerals not less than 3/8 inch (9.5 mm) high; attach to face of door on lockers and face of shelf on Turnout and Stadium, with two aluminum rivets.

**Locks:** Built-in flat key locks; master-

key to same series. Built-in grooved key locks (pin tumbler); master-key to same series. Built-in three-number dialing combination locks capable of at least five different combination changes; provide master key, combination change key and combination control chart. Padlocks: master-keyed three-number dialing combination type padlocks: provide master key.

**Channel Base:** 4-inch high. 14-gauge sheet forming a "C" channel attached to locker bottom. 6-inch high. 14-gauge sheet forming a "C" channel attached to locker bottom.

**Name Card Holder:** Plated steel. Holds 1.25" (31.75 mm) x 2.75" card (69.85 mm).

**Center Partition:** 16-gauge with flanged front. Attaches securely to shelf and locker bottom or additional lower shelf. (Not for use with footlocker or seat) Mounting holes for side shelves provided on nominal 6 inch centers.

**Side Shelf:** 16-gauge, used with center partition only. Flanged on three sides.

**Acrylic mirror:** Self adhesive, 6-inch (152.4 mm) x 8 inch (203.2 mm).

**Hooks:** Used for Coat Rod. Two heavy-duty single prong hooks with a diameter of 0.276 mounted to shelf and designed to accept a coat rod.

**Coat Rod, Full Length:** Using coat rod hooks mounted to shelf: 18-inch (used with 18-inch wide locker only); 24-inch (used with 24-inch wide locker only); 30-inch (used with 30-inch wide lockers only); 36-inch (used with 36-inch wide lockers only); 42-inch (used with 42-inch wide lockers only); 48-inch (used with 48-inch wide lockers only)

**Coat Rod, Half Length:** Using coat rod hooks mounted to shelf: 9-inch (used with 18-inch locker with center partition or half shelves); 12-inch (used with 24-inch locker with center partition or half shelves); 15-inch (used with 30-inch locker with center partition or half shelves); 36-inch (actually 18-inch long and used with 36-inch locker with center partition or half shelves); 42-inch

(actually 21-inch long and used with 42-inch locker with center partition or half shelves); 48-inch (actually 24-inch long and used with 48-inch locker with center partition or half shelves)

**Hooks:** Single prong hooks with a diameter of 0.187 in rear, mounted to shelf.

**Garment Separator:** Full width. Use as an alternative to the optional Coat Rod accessory. Attaches to shelf.

**Full width shelves:** 16-gauge, flanged on all four sides, formed to 90 degrees, front and back edge having a second bend, attached securely to mounting side rails. Optional Back Rails are available for additional shelf support when needed.

**Back Rails:** 16 gauge, Optional, one per shelf, used with Full Width Shelves when extra support is needed.

**Half Shelves:** "L" Shaped Half Shelves: 16-gauge, flanged on three sides and attached securely on one side with a side rail, and flanged partition mounted to shelf or half shelf above.

**Security Box, 12 inch:** 18-gauge lockable door with a 18-gauge side panel. The door is attached to a welded frame with a two-point hinge. The door is locked through a single point latch with a padlock or built-in lock. A door pull shall be provided for use with padlocks. Security box door frame to be not less than 16-gauge formed to a channel shape. Vertical members to have an additional flange to provide a continuous door strike. Widths: 9-inch, 12-inch, 15-inch, 18-inch, 21-inch, 24-inch.

**Security Box Panels:** Used with security box unit when ordering a flattened expanded metal division and a Security Box together, this panel is used in the inside of compartment to block the view from the outside.

## **PATRIOT® Fully Framed Lockers Accessories**

**Inner Compartment Door:** Attached to “L” shaped half shelf. 18 gauge.

**Inner Compartment Panels:** Used with inner compartment door unit, when ordering a flattened expanded metal division and an inner compartment door together, this panel is used in the inside of compartment to block the view from the outside.

**Cell Phone/Key Tray:** 8-inch (203.2 mm) x 2-inch (50.8 mm) x 2-inch (50.8 mm) mounted to center partition or half shelf. If either of these items are being ordered, you can attach it to the side of the locker using 2 side rails (ordered separately).

**Boot Tray:** Aluminum, measuring 14 x 12.

**Metal Seat only:** 14 gauge, mounted using mounting rails to vertical corner posts allowing adjustability.

**Hardwood Bench Seat only:** 1-1/4” thick full depth, mounted using mounting rails to vertical corner posts allowing adjustability.

**Individual Hardwood Seat for Duty Lockers:** 1-1/4” full finished thickness depth, Corners rounded and sanded, exposed surfaces finished with two coats of clear lacquer.

**Footlocker:** Recessed from locker frame to clear full-length locker door. Front footlocker panel includes single point latch with padlock strike plate and vertical slots. 14-gauge lid of footlocker has a continuous hinge and serves as a seat. Rubber bumpers mounted to the contact points quiet opening and closing of the lid. Two reinforcement channels welded to bottom strengthens seat lid. Two mounting side rails attached to the vertical posts support lid/seat.

**Document Sleeve Small:** 16 gauge measuring 9.5-inch x 3-inch x 8-inch

**Document Sleeve Large:** 16 gauge measuring 12-inch x 3-inch x 8-inch

**Drawer Base Unit for Duty Lockers:** 78-inch-high Duty lockers provide a

78-inches high locker with a 9-inch or 12-inch front extension to create the drawer base. 90-inch-high Duty lockers provide a 90-inches high locker with a 9-inch or 12-inch front extension to create the drawer base, 16-gauge drawer body, rated at 250 pounds per pair. Drawer face with integral finger grab and punched to accept built-in spring bolt locker lock, key lock or padlock.

**Bottom Drawers:** 12-inch high. Drawer body shall be constructed of 16-gauge sheet steel, mounted using an integral “C” channel and mounted to the side rails that are mounted to the corner posts.

**Intermediate Drawers:** 6-inch high. Drawer body shall be constructed of 16-gauge sheet steel, mounted using an integral “C” channel and mounted to the side rails that are mounted to the corner posts.

**Parachute/Body Armor Rack:** Formed from 3/4-inch diameter, heavy wall steel tube. Reinforced by 14-gauge gussets. Mounted securely to rear of locker. 180-pound capacity. Rack is attached by drilling holes in the locker back and using the nuts, bolts and washers supplied. If ordering welded this will be done at factory, if ordering knockdown must be done on site.

**Heavy-Duty Bench Pedestals:** Steel tubing with 11-gauge steel flanges welded to each end, 16-1/4 inches (412 mm) high, finish to match lockers.

**Stainless Steel Free-Standing Bench Pedestals:** 2-inch (50 mm) diameter brushed 16-gauge stainless steel formed into a trapezoid, 14-inch (355 mm) wide bottom with two 5/16 inch (7.9 mm) diameter holes, top flange with four 5/16 inch (7.9 mm) diameter holes for fastening to bench.

unsatisfactory preparation before proceeding.

### **3.02 INSTALLATION**

Install metal accessories at locations shown in accordance with manufacturer’s instructions. Install sloping tops and metal fillers using concealed fasteners. Provide flush hairline joints against adjacent surfaces. Install benches by fastening bench tops to pedestals and securely anchoring to the floor using appropriate anchors for the floor material.

### **3.03 ADJUSTING**

Adjust built-in locks to prevent binding of dial or key and ensure smooth operation prior to substantial completion.

Touch-up with factory-supplied paint and repair or replace damaged products before substantial completion.

### **3.04 PROTECTION**

Protect installed products until completion of project.

## **PART 3 – EXECUTION**

### **3.01 EXAMINATION**

Do not begin installation until substrates and bases have been properly prepared. If substrate and bases are the responsibility of another installer, notify Architect of

## ADA / Environmental

### Americans with Disabilities Act Information (ADA)

Penco lockers commonly accepted for ADA or barrier-free assignments are single tier and double-tier (lower tier only) when equipped with the Classic III recessed handle with multi-point latching: Vanguard, Guardian, Invincible II, Welded Gen2 and Angle Iron (with available modifications). Other handle types and certain lock selections may not be recognized as ADA compliant without modification.

Single tier 60" or 72" high lockers with the Classic III recessed multi-point latch handles must have shelves relocated and/or added to accommodate ADAAG mandated reach ranges. Two tier 36" high openings with the Classic III recessed handle may be used by designating the lower tier for ADA compliance. An extra shelf should be ordered to bring the lowest reach point within the prescribed ADAAG range based upon side or forward reach. Field drilling for these shelf locations on smaller requirements is recommended. The owner or architect may also require a



handicapped access sign be placed on the door.

Other handles and configurations may be specified, but these are the most appropriate based upon a literal interpretation. Attention should also be paid to the clear area in front of the lockers to meet other separate

but related guidelines. Contact your Penco Representative for assistance or go to [www.access-board.gov](http://www.access-board.gov) to view the ADA Accessibility guidelines in full.



### GREENGUARD

All products manufactured by Penco Products are GREENGUARD Gold Certified through UL Environment's GREENGUARD Certification Program. This certification signifies that Penco's products are now in compliance with the stringent chemical emissions guidelines set by UL Environment. Accredited courses are available to design professionals and fulfill credit

requirements for AIA, GBCI, IDCEC. Contact a Penco Sales Manager for more information.



### Environmental Information

- Based upon the most recent information from our source mills, the recycled content of our steel lockers can range from 25% to over 50%. Because the percentage of recycled content may vary from project to project based on a number of variables, please contact our offices for detailed information on your specific requirement.
- Powder coating drastically reduces waste through high efficiency application & recovery methods.
- Penco's powder coat paint contains no solvents and as a result releases no Volatile Organic Compounds (VOC's) normally associated with wet paint processes.
- Our packaging contains at least 20% post-consumer recycled content.
- Approximately 34% of the U.S. population lives within a 500 mile radius of our manufacturing facility, requiring less fuel to ship our products to many destinations.



ADA locker can optionally be marked with a decal.



ADA locker has shelf at least 15 inches from floor.

## 24 Brilliant Colors



NOTE: Colors shown are as close to actual finishes as the printing process allows. Do not make your final color selection based on the color shade shown on this page. Penco Color Charts are available for a more accurate color match. Exposure to high humidity, chlorine salts, abrasive cleaners, germicidal cleaners and acids can damage the finish and will void the guarantee. For outdoor applications or other harsh environmental conditions, contact your Penco representative.

### Standard Colors

To assure rust resistance and paint adhesion, all Penco steel products receive a state of the art pre-paint conditioning that includes a thorough cleansing by a hot spray washing process, then a specially formulated coating is applied creating a surface that resists corrosion and improves paint adhesion. All lockers are available in the 24 colors shown above.

### Standard Powder Coat Finish

Penco's standard 1 mil thick paint finish is perfect for most applications. The paint surface is tough and durable and offers a beautiful drip-free surface, excellent edge coverage and environmentally friendly application.

### PowderCoatPlus™

PowderCoatPlus is an optional cost-effective way of improving the durability and rust resistance. After a specialized cleaning and pre-treatment of the steel, a 2 mil thick coating of powder coat enamel is applied and baked onto the steel surface.

### Antimicrobial Paint

Antimicrobial Paint finishes offer an added level of protection against virus and disease-causing micro-organisms while increasing resistance to stain and odor-causing bacteria, yielding an easier-to-clean product with extended durability and aesthetic appeal.



### X-Off™ Anti-Graffiti Paint

Penco's optional X-Off Anti-Graffiti Paint for lockers provides a surface coating that allows easy removal of graffiti with alcohol and water. This specially formulated paint has a tight molecular structure that completely seals the locker surface, preventing graffiti and corrosive agents from penetrating the finish.

Supplies needed: 99% isopropyl alcohol, water, cleaning cloths, eye and hand protection.

# Garment Dispensers

Penco Products builds upon 50 years of experience in the design, fabrication and sales support of garment lockers through its acquisition of Steiner Systems, an industry trailblazer and leader. This experience, combined with Penco's long history of providing a full range of storage solutions, achieves an unmatched level of expertise to ensure a superior product and high level of customer support.

Our wide spectrum of professional garment distribution lockers includes hanging garment dispensers, folded garment dispensers, laundry lockups and towel and linen control centers. These robust products are designed and built to provide the end user with many years of uninterrupted service.

- Individual locker provides each user with a locked compartment for personal belongings including uniforms, equipment, supplies or tools
- Simultaneous access to all lockers by management is available through the master door
- All hardware is zinc plated and assembly rivets are rust-proof aluminum
- All Hanging Garment Lockers can be personalized with your company's logo. Ask your sales representative for more details.



4 Compartment   8 Compartment   Big 4 Compartment   Big 6 Compartment   Big 8 Compartment

Sales Managers - Hygiene and Textile Rental Products		
Sales Manager	Areas Served	Phone
Bob Brett, Northeast Regional Manager	CT, DC, DE, MA, MD, ME, NH, NJ, NY, OH, PA, RI, VT	215-375-2935
Tony Taylor, Southeast Regional Manager	AL, AR, FL, GA, KY, LA, MS, NC, TN, SC, VA, WV	770-331-0451
Mike Rochon, Central Regional Manager	IL, IN, IA, MI, MN, NE, ND, KS, MO, OK, SD, TX, WI	815-566-1691
Randy Polen, Western Regional Manager	AK, AZ, CA, CO, HI, ID, MT, NM, NV, OR, US, WA, WY	805-490-1551
Yves L'Esperance, Canada Regional Manager	CANADA	514-594-2354

## Hanging Garment Dispensers

Description	Garment Gray Part #	Silver Vein Part #	Lock Type	Overall Dimensions	Compartment Dimensions	Door Dimensions	Wt. (lbs.)	Height
4 Compartment "2 Over 2"	LF-2/2-GRY-CAM	LF-2/2-SLV-CAM	Cam	23-15/16"W	11-1/2"W	9-1/4"W 35-9/16"H	128	Standard Height 80-13/16"
	LF-2/2-GRY-TRNB	LF-2/2-SLV-TRNB	Turn Knob	21-7/16"D	21-7/16"D			
	LF-2/2-GRY-COM	LF-2/2-SLV-COM	Combo	80-13/16"H	35-11/16"H			
Big 4 Compartment	LF-BG4-GRY-CAM	LF-BG4-SLV-CAM	Cam	30-19/32"W	14-7/8"W	12-5/8"W 35-9/16" H	145	Heights With Accessories With Base: 85"
	LF-BG4-GRY-TRNB	LF-BG4-SLV-TRNB	Turn Knob	21-7/16"D	21-7/16"D			
	LF-BG4-GRY-COM	LF-BG4-SLV-COM	Combo	80-13/16"H	35-11/16"H			
Big 6 Compartment	LF-BG6-GRY-CAM	LF-BG6-SLV-CAM	Cam	30-19/32"W	9-3/4"W	8-1/2"W 35-9/16"H	157	With Slope Top: 87"
	LF-BG6-GRY-TRNB	LF-BG6-SLV-TRNB	Turn Knob	21-7/16"D	21-7/16"D			
	LF-BG6-GRY-COM	LF-BG6-SLV-COM	Combo	80-13/16"H	35-11/16"H			
8 Compartment	LF-8C-GRY-CAM	LF-8C-SLV-CAM	Cam	23-15/16"W	5-3/4"W	4-3/4"W 35-9/16"H	147	With Base & Slope Top: 91"
	LF-8C-GRY-TRNB	LF-8C-SLV-TRNB	Turn Knob	21-7/16"D	21-7/16"D			
	LF-8C-GRY-COM	LF-8C-SLV-COM	Combo	80-13/16"H	35-11/16"H			
Big 8 Compartment	LF-BG8-GRY-CAM	LF-BG8-SLV-CAM	Cam	30-19/32"W	7-1/2"W	6-5/16"W 35-9/16"H	169	
	LF-BG8-GRY-TRNB	LF-BG8-SLV-TRNB	Turn Knob	21-7/16"D	21-7/16"D			
	LF-BG8-GRY-COM	LF-BG8-SLV-COM	Combo	80-13/16"H	35-11/16"H			



## Folded Garment Dispensers & Laundry Lockups



9 Compartment

10 Compartment

16 Compartment

Laundry Lockups					
Description	Garment Gray Part #	Silver Vein Part #	Laundry Lockup Dimensions	Swing Door Dimensions	Wt. (lbs.)
Maxi Laundry Lockup	LF-LDM-GRY	LF-LDM-SLV	23-15/16"W 21-7/16"D 80-13/16"H	21-11/16"W 12-1/2"H	105
Standard Laundry Lockup	LF-LDS-GRY	LF-LDS-SLV	16-1/4"W 21-7/16"D 80-13/16"H	13-3/4"W 12-1/2"H	78
Mini Laundry Lockup	10200-GRAY	10200-SLVN	16-1/2"W 16"D 39-1/4"H	11"W 8-3/4"H	35

### Laundry Lockups

- Choose from three sizes: mini, standard and maxi Laundry Lockups
- Holds between 35 and 140 plus pounds of soiled products
- Provides security of soiled merchandise
- Prevents theft and misuse of secured merchandise
- Reduces fire and sanitation hazards

Folded Garment Dispensers						
Description	Garment Gray Part #	Silver Vein Part #	Lock Type	Overall Dimensions	Door Dimensions	Wt. (lbs.)
9 Compartment	13100-GRAY	N/A	Cam	24"W 16"D	19-1/2"W 8"H	128
	13700-GRAY	N/A	Turn Knob	80-3/16"H		
10 Compartment	12100-GRAY	N/A	Cam	16-1/2"W 16"D	12"W 7"H	100
	12700-GRAY	N/A	Turn Knob	77-1/2"H		
16 Compartment	11100-GRAY	N/A	Cam	16-1/2"W 16"D	12"W 4-1/2"H	110
	11700-GRAY	N/A	Turn Knob	77-1/2"H		

### Folded Garment Dispensers

- Individual locker gives the user their own locked compartment for personal belongings including uniforms, equipment, supplies, or tools
- Simultaneous access to all lockers by management is available through the master door
- Simply turn one key and open all locker compartments at once
- Penco folded garment lockers are furnished with standard cam locks or turn knobs



Maxi Laundry Lockup

Standard Laundry Lockup

Mini Laundry Lockup

#### Locks & Knobs

#### Optional Accessories



Cam Lock with 2 keys



Master Keyed Combination Lock



Turn Knob (padlock not included)

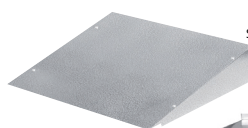

Slope Top



Closed Base

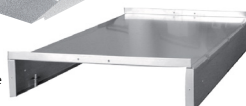

Open Base



Garment Gray



Silver Vein

Choice of two powder coated colors on most models.

# Shelving Systems

## Solutions for Every Application

Penco Products has set the standard for quality and design in material handling products, systems and equipment. We have earned a reputation for well-built products, excellent engineering and attentive customer service. All shelving products are designed and constructed from structural steel components for optimum strength, rigidity and safety.

Commercial shelving systems and pallet storage racks are popular with warehousing and manufacturing applications, ranging from a few units to multi-tier installations.

Penco's Clipper® and Erectomatic® Shelving lines are each completely configurable and can be integrated seamlessly with other Penco product lines by our engineering department.

Both Clipper and Erectomatic shelving lines share the same shelf. Penco Hi-Performance® shelves are made with a box-beam construction that produces a high strength-to-weight ratio. Carrying capacities vary depending on whether a medium duty, heavy duty or extra heavy duty shelf is

used. Many sizes are available.

Shelving systems can be designed as "closed" installations with solid backs and welded side panels, or as "open" style structures that are held together with side and rear sway bracing.

All Penco Storage Systems are available with drawings that have been reviewed and approved by a structural engineer licensed in the state where the installation will take place.

Each engineered shelving system is custom designed to account for all the specific conditions such as building columns and door locations. Careful consideration is given to insure that they are designed to comply with structural requirements for the seismic zone where the project will be installed.



## Corporate Information



The parent company of Penco Products and its affiliates is Industrial Manufacturing Company (IMC). IMC and its international arm, IMCI, are a proud family of companies that produce a wide variety of innovative products for industry.

With more than 3,500 direct employees and over 34 worldwide manufacturing, sales and distribution facilities, we provide tier-one products and services to some of the most demanding industries imaginable.

This vast diversity of global resources and networking infrastructure allows us to utilize the strengths of each company, learn from each other and create a technological advantage within each industry. Common to every associate in our family

of companies, is the profound respect for and the integrity of established industrial principles and practical openness to applications of new technology. With individual company histories spanning decades, and in two cases, more than a century, the IMC and IMCI companies are time-tested leaders in their national and global markets.



[www.mfgco.com](http://www.mfgco.com)

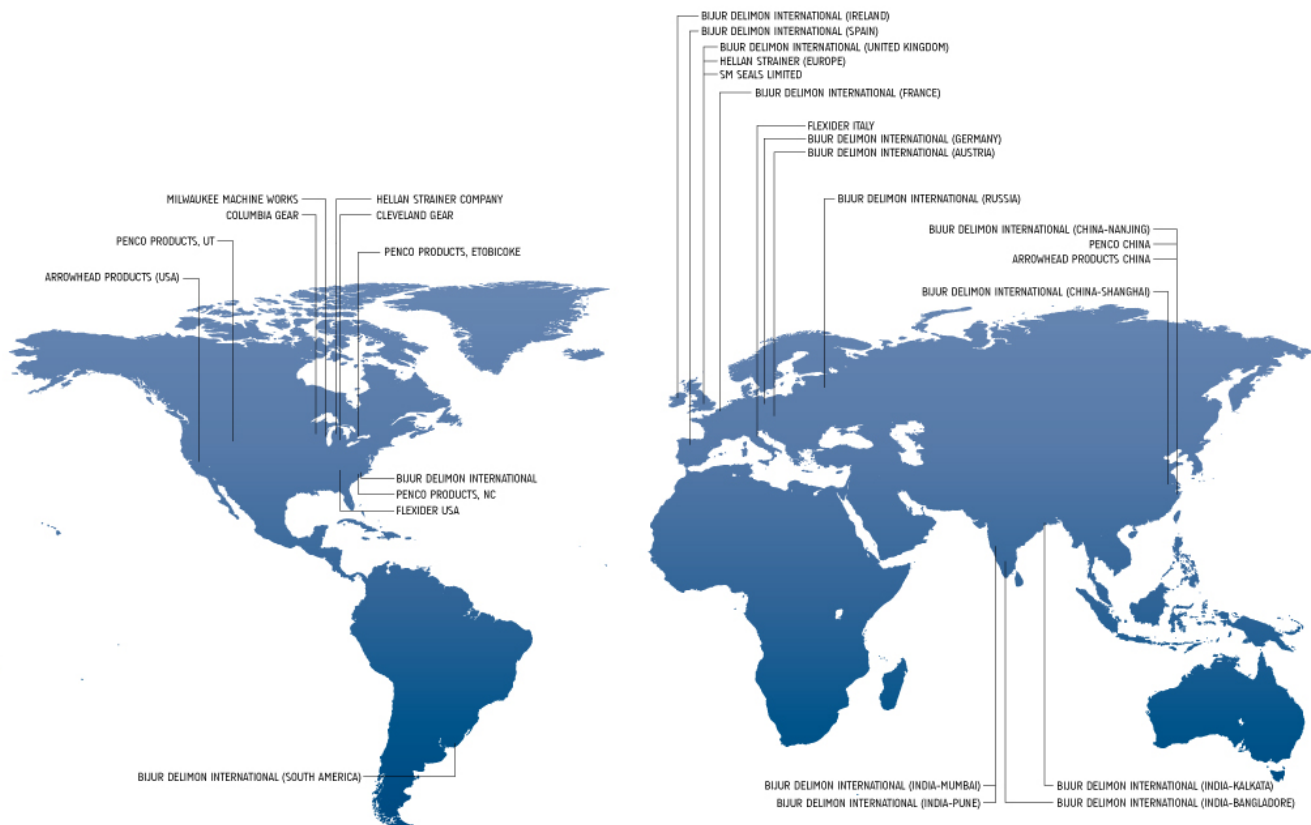

STEEL LOCKERS

STEEL INDUSTRIAL SHELVING

HYGIENE PRODUCTS

@PENCOPRODUCTS



WWW.PENCOPRODUCTS.COM



**Material Handling USA**

**800-326-4403**

<https://www.mh-usa.com/>  
[Sales@MaterialHandling-USA.com](mailto:Sales@MaterialHandling-USA.com)

© Copyright 2021 Penco Products, Inc.

LOCKERCATALOG NOVEMBER\_14\_2023