



 **Material Handling USA**

**Call Now for a Free
Quote or Site Visit!**

222 S. Main St. 5th Floor
Salt Lake City, UT 84101
800-326-4403
<https://www.mh-usa.com/>

SUPERSTORE

MH-USA

Material Handling USA

Material Handling Catalog

Boltless Shelving
Pages 2-13



Wire Shelving
Pages 30-34



FastRak™ Shelving
Pages 18-25



Cantilever Racks
Pages 28-29



Storage Bins & Boxes
Page 40



Workbenches
Page 35-37



Archive Shelving
Pages 26-27



Your Source For Warehouse Shelving, Equipment & Supplies.

Series 300B Features 3/4" Particle Board Decking

- » Industrial grade shelving
- » Accessible from all four sides
- » Heavy duty construction
- » Shelves adjust on 1½" Centers
- » No nuts, bolts or shelf clips

Bulk Storage Shelving offers a low cost way to store heavy and/or bulky items. Boltless design provides for easy assembly without nuts, bolts or shelf clips. No cross braces are necessary which makes these units accessible from all four sides. Available in a variety of sizes and capacities to meet your specific requirements. Shelves are easily adjustable every 1½". Units are priced in our most popular height of 7', but can be ordered in heights ranging from 3' to 12' to fit your specific needs. Steel color: Powder coated gray. All units come complete with either particle board decking, or laminated board decking. Individual units can be connected using interlocking Tie Plates. Tie Plates sold separately (see page 12)

Model Number Code:	3B3-7218-84	W/L	HCR
Series 300B	_____	_____	_____
Number of Shelves	_____	_____	_____
Shelf Width in Inches	_____	_____	_____
Shelf Depth in Inches	_____	_____	_____
Unit Height in Inches	_____	_____	_____
Decking*	_____	_____	_____
Shelf Deck Support Included (1 per shelf)	_____	_____	_____
Channel Beam	_____	_____	_____
Heavy Duty Channel Beam	_____	_____	_____
1 7/8" x 1 7/8" Heavy Duty Post	_____	_____	_____

*W - 3/4" Particle Board
 *L - 3/4" Laminated Board



Double Rivet Beams are used throughout the unit (front to back & left to right) to create a high capacity industrial grade unit



Decking sits on Double Rivet Beams

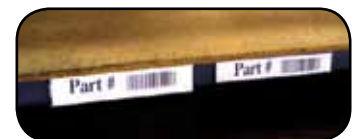

Label Holders
 See page 13 for details



Particle Board Decking

- Low cost durable decking
- ¾" thick



Laminated Board Decking

- Durable Laminated particle board
- Smooth shelf surface
- Improves appearance
- ¾" thick

Size W x D	Shelf Cap.	¾" Particle Board Decking				¾" Laminated Board Decking			
		3 Shelf Unit	Price	Extra Shelf	Price	3 Shelf Unit	Price	Extra Shelf	Price
		7' Height				7' Height			
48" x 12"	1,000	3B3-4812-84W	116.08	3BX1-4812-W	24.45	3B3-4812-84L	131.86	3BX1-4812-L	29.72
48" x 18"	1,000	3B3-4818-84W	131.20	3BX1-4818-W	29.49	3B3-4818-84L	154.85	3BX1-4818-L	37.38
48" x 24"	1,000	3B3-4824-84W	146.19	3BX1-4824-W	34.49	3B3-4824-84L	177.79	3BX1-4824-L	45.02
48" x 30"	1,000	3B3-4830-84W	162.00	3BX1-4830-W	39.76	3B3-4830-84L	201.47	3BX1-4830-L	52.92
48" x 36"	1,000	3B3-4836-84WH	200.88	3BX1-4836-WH	50.79	3B3-4836-84LH	248.22	3BX1-4836-LH	60.77
48" x 48"	1,000	3B3-4848-84WH	238.08	3BX1-4848-WH	62.77	3B3-4848-84LH	301.20	3BX1-4848-LH	76.36
60" x 18"	750	3B3-6018-84W	153.75	3BX1-6018-W	37.01	3B3-6018-84L	183.33	3BX1-6018-L	46.87
60" x 18"	1,200	3B3-6018-84WH	169.06	3BX1-6018-WH	40.87	3B3-6018-84LH	198.64	3BX1-6018-LH	50.73
60" x 24"	750	3B3-6024-84W	171.52	3BX1-6024-W	42.93	3B3-6024-84L	210.99	3BX1-6024-L	56.09
60" x 24"	1,200	3B3-6024-84WH	190.04	3BX1-6024-WH	47.57	3B3-6024-84LH	229.51	3BX1-6024-LH	60.72
60" x 30"	750	3B3-6030-84W	190.10	3BX1-6030-W	49.13	3B3-6030-84L	239.40	3BX1-6030-L	65.56
60" x 30"	1,200	3B3-6030-84WH	210.96	3BX1-6030-WH	54.25	3B3-6030-84LH	260.25	3BX1-6030-LH	70.69
60" x 36"	750	3B3-6036-84W	208.47	3BX1-6036-W	55.25	3B3-6036-84L	267.69	3BX1-6036-L	74.99
60" x 36"	1,200	3B3-6036-84WH	231.65	3BX1-6036-WH	61.05	3B3-6036-84LH	290.87	3BX1-6036-LH	80.79
60" x 48"	750	3B3-6048-84W	244.98	3BX1-6048-W	67.42	3B3-6048-84L	323.88	3BX1-6048-L	93.72
60" x 48"	1,200	3B3-6048-84WH	274.40	3BX1-6048-WH	74.88	3B3-6048-84LH	353.30	3BX1-6048-LH	101.18
72" x 18"	600	3B3-7218-84W	171.61	3BX1-7218-W	42.97	3B3-7218-84L	207.14	3BX1-7218-L	54.81
72" x 18"	1,000	3B3-7218-84WH	186.92	3BX1-7218-WH	46.82	3B3-7218-84LH	222.45	3BX1-7218-LH	58.66
72" x 18"	1,500	3B3-7218-84WHC	206.64	3BX1-7218-WHC	53.39	3B3-7218-84LHC	242.17	3BX1-7218-LHC	65.24
72" x 18"	2,000	3B3-7218-84WHR	252.02	3BX1-7218-WHR	66.93	3B3-7218-84LHR	287.55	3BX1-7218-LHR	78.77
72" x 24"	600	3B3-7224-84W	192.18	3BX1-7224-W	49.82	3B3-7224-84L	239.53	3BX1-7224-L	65.60
72" x 24"	1,000	3B3-7224-84WH	210.70	3BX1-7224-WH	54.45	3B3-7224-84LH	258.05	3BX1-7224-LH	70.23
72" x 24"	1,500	3B3-7224-84WHC	230.42	3BX1-7224-WHC	61.03	3B3-7224-84LHC	277.77	3BX1-7224-LHC	76.81
72" x 24"	2,000	3B3-7224-84WHR	275.80	3BX1-7224-WHR	74.85	3B3-7224-84LHR	323.15	3BX1-7224-LHR	90.64
72" x 30"	600	3B3-7230-84W	213.44	3BX1-7230-W	56.91	3B3-7230-84L	272.66	3BX1-7230-L	76.65
72" x 30"	1,000	3B3-7230-84WH	234.30	3BX1-7230-WH	62.03	3B3-7230-84LH	293.52	3BX1-7230-LH	81.77
72" x 30"	1,500	3B3-7230-84WHC	254.02	3BX1-7230-WHC	68.61	3B3-7230-84LHC	313.24	3BX1-7230-LHC	88.35
72" x 30"	2,000	3B3-7230-84WHR	299.40	3BX1-7230-WHR	82.72	3B3-7230-84LHR	358.62	3BX1-7230-LHR	102.46
72" x 36"	600	3B3-7236-84W	234.64	3BX1-7236-W	63.98	3B3-7236-84L	305.68	3BX1-7236-L	87.65
72" x 36"	1,000	3B3-7236-84WH	257.83	3BX1-7236-WH	69.77	3B3-7236-84LH	328.86	3BX1-7236-LH	93.45
72" x 36"	1,500	3B3-7236-84WHC	277.55	3BX1-7236-WHC	76.35	3B3-7236-84LHC	348.58	3BX1-7236-LHC	100.02
72" x 36"	2,000	3B3-7236-84WHR	322.93	3BX1-7236-WHR	90.56	3B3-7236-84LHR	393.96	3BX1-7236-LHR	106.51
72" x 48"	600	3B3-7248-84W	276.60	3BX1-7248-W	77.96	3B3-7248-84L	371.32	3BX1-7248-L	109.54
72" x 48"	1,000	3B3-7248-84WH	306.02	3BX1-7248-WH	85.42	3B3-7248-84LH	400.74	3BX1-7248-LH	116.99
72" x 48"	1,500	3B3-7248-84WHC	325.74	3BX1-7248-WHC	91.99	3B3-7248-84LHC	420.46	3BX1-7248-LHC	123.56
72" x 48"	2,000	3B3-7248-84WHR	371.12	3BX1-7248-WHR	106.63	3B3-7248-84LHR	465.84	3BX1-7248-LHR	138.20
96" x 18"	600	3B3-9618-84WH	223.56	3BX1-9618-WH	59.03	3B3-9618-84LH	270.90	3BX1-9618-LH	74.81
96" x 18"	1,000	3B3-9618-84WHC	250.65	3BX1-9618-WHC	68.06	3B3-9618-84LHC	297.99	3BX1-9618-LHC	83.84
96" x 18"	1,500	3B3-9618-84WHR	310.45	3BX1-9618-WHR	86.40	3B3-9618-84LHR	357.80	3BX1-9618-LHR	102.19
96" x 24"	600	3B3-9624-84WH	252.82	3BX1-9624-WH	68.49	3B3-9624-84LH	315.95	3BX1-9624-LH	89.53
96" x 24"	1,000	3B3-9624-84WHC	279.91	3BX1-9624-WHC	77.52	3B3-9624-84LHC	343.04	3BX1-9624-LHC	98.56
96" x 24"	1,500	3B3-9624-84WHR	339.72	3BX1-9624-WHR	96.16	3B3-9624-84LHR	402.84	3BX1-9624-LHR	117.20
96" x 30"	600	3B3-9630-84WH	281.96	3BX1-9630-WH	77.92	3B3-9630-84LH	360.86	3BX1-9630-LH	104.22
96" x 30"	1,000	3B3-9630-84WHC	309.05	3BX1-9630-WHC	86.95	3B3-9630-84LHC	387.95	3BX1-9630-LHC	113.25
96" x 30"	1,500	3B3-9630-84WHR	368.85	3BX1-9630-WHR	105.87	3B3-9630-84LHR	447.76	3BX1-9630-LHR	132.17
96" x 36"	600	3B3-9636-84WH	310.94	3BX1-9636-WH	87.48	3B3-9636-84LH	405.66	3BX1-9636-LH	119.05
96" x 36"	1,000	3B3-9636-84WHC	338.03	3BX1-9636-WHC	96.51	3B3-9636-84LHC	432.75	3BX1-9636-LHC	128.08
96" x 36"	1,500	3B3-9636-84WHR	397.83	3BX1-9636-WHR	115.53	3B3-9636-84LHR	492.56	3BX1-9636-LHR	147.11
96" x 48"	600	3B3-9648-84WH	370.16	3BX1-9648-WH	106.80	3B3-9648-84LH	496.44	3BX1-9648-LH	148.89
96" x 48"	1,000	3B3-9648-84WHC	397.25	3BX1-9648-WHC	115.83	3B3-9648-84LHC	523.53	3BX1-9648-LHC	157.92
96" x 48"	1,500	3B3-9648-84WHR	457.05	3BX1-9648-WHR	135.27	3B3-9648-84LHR	583.34	3BX1-9648-LHR	177.37

Series 300A Features 3/4" Particle Board Decking

- » **Industrial grade shelving**
- » **No nuts, bolts or shelf clips**
- » **Accessible from all four sides**
- » **Shelves adjust on 1½" Centers**

This extra heavy duty shelving is constructed using industrial strength steel and features an advanced boltless design which provides easy assembly without nuts, bolts or shelf clips. Double Rivet Beams at top and bottom of unit form a rigid structure without the use of troublesome crossbars. Steel color: Powder coated gray.



Top & bottom shelves utilize Double Rivet Beams to form a rigid structure



Intermediate Shelves feature Single Rivet Beams for attractive Low Profile Design



Units can be connected using interlocking Tie Plates.
See page 12 for pricing.





Particle Board Decking

- Low cost durable decking
- 3/4" thick

Units are priced in our most popular height of 7' but can be ordered in heights ranging from 3' to 12' to fit your specific needs. Extra Heavy Load Capacity units are priced complete with 3/4" particle board decking or laminated decking. Units come standard with 5 shelves. Customize units by ordering additional shelves that adjust on 1 1/2" centers. Individual units can be connected using interlocking Tie Plates. Tie Plates sold separately (see page 12). All units come complete with either 3/4" particle board decking, or 3/4" laminated board decking.



Laminated Decking

- Durable Laminated particle board
- Smooth shelf surface
- White surface improves appearance
- 3/4" thick



Model Number Code:

3A 5-4824-84W / L

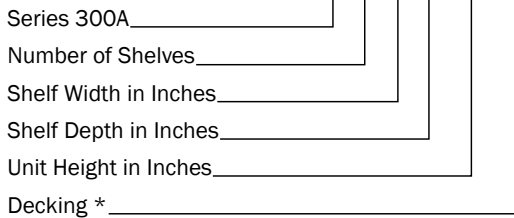

*W - 3/4" Particle Board

*L - 3/4" Laminated Board

Size W x D	Shelf Capacity	3/4" Particle Board Decking				3/4" Laminated Board Decking			
		5 Shelf Unit	Price	Extra Shelf	Price	5 Shelf Unit	Price	Extra Shelf	Price
7' Height									
36" x 12"	500	3A5-3612-84W	141.21	3AX1-3612-W	19.75	3A5-3612-84L	161.01	3AX1-3612-L	18.67
36" x 18"	500	3A5-3618-84W	161.28	3AX1-3618-W	23.69	3A5-3618-84L	190.89	3AX1-3618-L	29.61
36" x 24"	500	3A5-3624-84W	180.30	3AX1-3624-W	27.29	3A5-3624-84L	219.72	3AX1-3624-L	35.18
36" x 30"	500	3A5-3630-84W	201.35	3AX1-3630-W	31.42	3A5-3630-84L	250.70	3AX1-3630-L	41.29
48" x 12"	375	3A5-4812-84W	167.44	3AX1-4812-W	23.49	3A5-4812-84L	193.75	3AX1-4812-L	28.75
48" x 18"	375	3A5-4818-84W	192.08	3AX1-4818-W	30.12	3A5-4818-84L	231.50	3AX1-4818-L	38.01
48" x 24"	375	3A5-4824-84W	215.55	3AX1-4824-W	34.62	3A5-4824-84L	268.21	3AX1-4824-L	45.15
48" x 30"	375	3A5-4830-84W	241.28	3AX1-4830-W	39.68	3A5-4830-84L	307.06	3AX1-4830-L	52.84
48" x 36"	375	3A5-4836-84W	264.59	3AX1-4836-W	43.96	3A5-4836-84L	343.50	3AX1-4836-L	59.75
60" x 12"	250	3A5-6012-84W	195.69	3AX1-6012-W	30.29	3A5-6012-84L	228.61	3AX1-6012-L	36.88
60" x 18"	250	3A5-6018-84W	224.94	3AX1-6018-W	36.07	3A5-6018-84L	274.24	3AX1-6018-L	45.93
60" x 24"	250	3A5-6024-84W	253.04	3AX1-6024-W	41.49	3A5-6024-84L	318.82	3AX1-6024-L	54.64
60" x 30"	250	3A5-6030-84W	283.38	3AX1-6030-W	47.47	3A5-6030-84L	365.55	3AX1-6030-L	63.90
60" x 36"	250	3A5-6036-84W	311.16	3AX1-6036-W	52.65	3A5-6036-84L	409.86	3AX1-6036-L	72.39

Series 200B Features 1/2" Particle Board Decking

- » Industrial grade shelving
- » Accessible from all four sides
- » Heavy duty construction
- » Shelves adjust on 1½" Centers
- » No nuts, bolts or shelf clips

Heavy Duty Shelving offers a low cost way to store heavy and/or bulky items. Boltless design provides for easy assembly without nuts, bolts or shelf clips. No cross braces are necessary which makes these units accessible from all four sides. Available in a variety of sizes and capacities to meet your specific requirements. Shelves are easily adjustable every 1½". Units are priced in our most popular height of 7', but can be ordered in heights ranging from 3' to 12' to fit your specific needs. Steel color: Powder coated gray. All units come complete with either particle board decking, laminated board decking, or wire mesh decking. Individual units can be connected using interlocking Tie Plates. Tie Plates sold separately (see page 12)

Model Number Code: **2B3-7218-84 W/L/T HC**

Series 200B	_____	_____	_____	_____	_____
Number of Shelves	_____	_____	_____	_____	_____
Shelf Width in Inches	_____	_____	_____	_____	_____
Shelf Depth in Inches	_____	_____	_____	_____	_____
Unit Height in Inches	_____	_____	_____	_____	_____
Decking*	_____	_____	_____	_____	_____
Shelf Deck Support Included (1 per shelf)	_____	_____	_____	_____	_____
Channel Beam	_____	_____	_____	_____	_____

*W - 1/2" Particle Board
 *L - 1/2" Laminated Board
 *T - Wire Mesh



Double Rivet Beams are used throughout the unit (front to back & left to right) to create a high capacity industrial grade unit



Decking sits on Double Rivet Beams

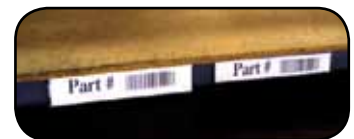

Label Holders
 See page 13 for details

Particle Board Decking



- Low cost durable decking
- 1/2" thick

Laminated Board Decking



- Durable Laminated particle board
- Smooth shelf surface
- Improves appearance
- 1/2" thick

Wire Mesh Decking



- Reduces dust build up
- Silver powder coated finish
- 2" x 4" openings between wire
- Heavy duty 5 gauge construction

Size W x D	Shelf Capacity	1/2" Particle Board Decking				1/2" Laminated Board Decking				Wire Mesh Decking			
		3 Shelf Unit	Price	Extra Shelf	Price	3 Shelf Unit	Price	Extra Shelf	Price	3 Shelf Unit	Price	Extra Shelf	Price
		7' Height				7' Height				7' Height			
48" x 12"	900	2B3-4812-84W	109.81	2BX1-4812-W	22.37	2B3-4812-84L	125.56	2BX1-4812-L	27.62	2B3-4812-84T	117.68	2BX1-4812-T	24.99
48" x 18"	900	2B3-4818-84W	121.75	2BX1-4818-W	26.34	2B3-4818-84L	145.40	2BX1-4818-L	34.23	2B3-4818-84T	135.20	2BX1-4818-T	30.83
48" x 24"	900	2B3-4824-84W	133.62	2BX1-4824-W	30.30	2B3-4824-84L	165.19	2BX1-4824-L	40.82	2B3-4824-84T	148.27	2BX1-4824-T	35.19
48" x 30"	900	2B3-4830-84W	146.29	2BX1-4830-W	34.52	2B3-4830-84L	185.72	2BX1-4830-L	47.67	N/A	N/A	N/A	N/A
48" x 36"	900	2B3-4836-84WH	176.21	2BX1-4836-WH	44.50	2B3-4836-84LH	223.52	2BX1-4836-LH	54.47	2B3-4836-84TH	203.93	2BX1-4836-TH	53.74
48" x 48"	900	2B3-4848-84WH	205.85	2BX1-4848-WH	54.38	2B3-4848-84LH	268.95	2BX1-4848-LH	75.41	2B3-4848-84TH	242.14	2BX1-4848-TH	66.48
60" x 18"	650	2B3-6018-84W	141.84	2BX1-6018-W	33.04	2B3-6018-84L	171.52	2BX1-6018-L	42.93	N/A	N/A	N/A	N/A
60" x 18"	1,100	2B3-6018-84WH	153.41	2BX1-6018-WH	36.90	2B3-6018-84LH	183.08	2BX1-6018-LH	46.79	N/A	N/A	N/A	N/A
60" x 24"	650	2B3-6024-84W	155.80	2BX1-6024-W	37.70	2B3-6024-84L	195.24	2BX1-6024-L	50.84	N/A	N/A	N/A	N/A
60" x 24"	1,100	2B3-6024-84WH	169.69	2BX1-6024-WH	42.33	2B3-6024-84LH	209.13	2BX1-6024-LH	55.47	N/A	N/A	N/A	N/A
60" x 30"	650	2B3-6030-84W	170.42	2BX1-6030-W	42.57	2B3-6030-84L	219.71	2BX1-6030-L	59.00	N/A	N/A	N/A	N/A
60" x 30"	1,100	2B3-6030-84WH	185.79	2BX1-6030-WH	47.69	2B3-6030-84LH	235.08	2BX1-6030-LH	64.12	N/A	N/A	N/A	N/A
60" x 36"	650	2B3-6036-84W	184.87	2BX1-6036-W	47.39	2B3-6036-84L	244.06	2BX1-6036-L	67.12	N/A	N/A	N/A	N/A
60" x 36"	1,100	2B3-6036-84WH	202.26	2BX1-6036-WH	53.18	2B3-6036-84LH	261.45	2BX1-6036-LH	72.91	N/A	N/A	N/A	N/A
60" x 48"	650	2B3-6048-84W	213.51	2BX1-6048-W	56.93	2B3-6048-84L	292.38	2BX1-6048-L	83.22	N/A	N/A	N/A	N/A
60" x 48"	1,100	2B3-6048-84WH	235.87	2BX1-6048-WH	64.39	2B3-6048-84LH	314.75	2BX1-6048-LH	90.68	N/A	N/A	N/A	N/A
72" x 18"	500	2B3-7218-84W	157.50	2BX1-7218-W	38.26	2B3-7218-84L	192.97	2BX1-7218-L	50.09	N/A	N/A	N/A	N/A
72" x 18"	900	2B3-7218-84WH	169.06	2BX1-7218-WH	42.12	2B3-7218-84LH	204.53	2BX1-7218-LH	53.94	2B3-7218-84TH	189.19	2BX1-7218-TH	48.83
72" x 18"	1,100	2B3-7218-84WHC	188.78	2BX1-7218-WHC	48.69	2B3-7218-84LHC	224.25	2BX1-7218-LHC	60.51	2B3-7218-84THC	208.91	2BX1-7218-THC	55.40
72" x 24"	500	2B3-7224-84W	173.31	2BX1-7224-W	43.53	2B3-7224-84L	220.63	2BX1-7224-L	59.30	N/A	N/A	N/A	N/A
72" x 24"	900	2B3-7224-84WH	187.20	2BX1-7224-WH	48.16	2B3-7224-84LH	234.52	2BX1-7224-LH	63.93	2B3-7224-84TH	213.70	2BX1-7224-TH	56.99
72" x 24"	1,100	2B3-7224-84WHC	206.92	2BX1-7224-WHC	54.74	2B3-7224-84LHC	254.24	2BX1-7224-LHC	70.51	2B3-7224-84THC	233.42	2BX1-7224-THC	63.57
72" x 30"	500	2B3-7230-84W	189.85	2BX1-7230-W	49.05	2B3-7230-84L	249.04	2BX1-7230-L	68.78	N/A	N/A	N/A	N/A
72" x 30"	900	2B3-7230-84WH	205.22	2BX1-7230-WH	54.17	2B3-7230-84LH	264.41	2BX1-7230-LH	73.90	N/A	N/A	N/A	N/A
72" x 30"	1,100	2B3-7230-84WHC	224.94	2BX1-7230-WHC	60.74	2B3-7230-84LHC	284.13	2BX1-7230-LHC	80.47	N/A	N/A	N/A	N/A
72" x 36"	500	2B3-7236-84W	206.33	2BX1-7236-W	54.54	2B3-7236-84L	277.33	2BX1-7236-L	78.20	N/A	N/A	N/A	N/A
72" x 36"	900	2B3-7236-84WH	223.71	2BX1-7236-WH	60.33	2B3-7236-84LH	294.71	2BX1-7236-LH	84.00	2B3-7236-84TH	262.40	2BX1-7236-TH	73.23
72" x 36"	1,100	2B3-7236-84WHC	243.43	2BX1-7236-WHC	66.91	2B3-7236-84LHC	314.43	2BX1-7236-LHC	90.57	2B3-7236-84THC	282.11	2BX1-7236-THC	79.80
72" x 48"	500	2B3-7248-84W	238.86	2BX1-7248-W	65.38	2B3-7248-84L	333.52	2BX1-7248-L	96.94	N/A	N/A	N/A	N/A
72" x 48"	900	2B3-7248-84WH	261.23	2BX1-7248-WH	72.84	2B3-7248-84LH	355.89	2BX1-7248-LH	104.39	2B3-7248-84TH	312.17	2BX1-7248-TH	89.82
72" x 48"	1,100	2B3-7248-84WHC	280.95	2BX1-7248-WHC	79.41	2B3-7248-84LHC	375.61	2BX1-7248-LHC	110.96	2B3-7248-84THC	331.88	2BX1-7248-THC	96.39
96" x 18"	500	2B3-9618-84WH	200.94	2BX1-9618-WH	52.74	2B3-9618-84LH	248.25	2BX1-9618-LH	68.51	2B3-9618-84TH	231.59	2BX1-9618-TH	62.96
96" x 18"	900	2B3-9618-84WHC	228.03	2BX1-9618-WHC	61.77	2B3-9618-84LHC	275.34	2BX1-9618-LHC	77.54	2B3-9618-84THC	258.68	2BX1-9618-THC	71.99
96" x 24"	500	2B3-9624-84WH	223.02	2BX1-9624-WH	60.10	2B3-9624-84LH	286.11	2BX1-9624-LH	81.13	2B3-9624-84TH	256.91	2BX1-9624-TH	71.40
96" x 24"	900	2B3-9624-84WHC	250.11	2BX1-9624-WHC	69.13	2B3-9624-84LHC	313.20	2BX1-9624-LHC	90.16	2B3-9624-84THC	284.00	2BX1-9624-THC	80.43
96" x 30"	500	2B3-9630-84WH	245.01	2BX1-9630-WH	67.43	2B3-9630-84LH	323.88	2BX1-9630-LH	93.72	N/A	N/A	N/A	N/A
96" x 30"	900	2B3-9630-84WHC	272.10	2BX1-9630-WHC	76.46	2B3-9630-84LHC	350.97	2BX1-9630-LHC	102.75	N/A	N/A	N/A	N/A
96" x 36"	500	2B3-9636-84WH	267.40	2BX1-9636-WH	74.90	2B3-9636-84LH	362.06	2BX1-9636-LH	106.45	2B3-9636-84TH	317.08	2BX1-9636-TH	91.46
96" x 36"	900	2B3-9636-84WHC	294.49	2BX1-9636-WHC	83.93	2B3-9636-84LHC	389.15	2BX1-9636-LHC	115.48	2B3-9636-84THC	344.17	2BX1-9636-THC	100.49
96" x 48"	500	2B3-9648-84WH	312.76	2BX1-9648-WH	90.02	2B3-9648-84LH	438.98	2BX1-9648-LH	132.09	2B3-9648-84TH	378.32	2BX1-9648-TH	111.87
96" x 48"	900	2B3-9648-84WHC	339.85	2BX1-9648-WHC	99.05	2B3-9648-84LHC	466.07	2BX1-9648-LHC	141.12	2B3-9648-84THC	405.41	2BX1-9648-THC	120.90

Series 200A Features 1/2" Particle Board Decking

- » **Industrial grade shelving**
- » **No nuts, bolts or shelf clips**
- » **Accessible from all four sides**
- » **Shelves adjust on 1 1/2" Centers**

This heavy duty shelving is constructed using industrial strength steel and features an advanced boltless design which provides easy assembly without nuts, bolts or shelf clips. Double Rivet Beams at top and bottom of unit form a rigid structure without the use of troublesome crossbars. Steel color: Powder coated gray.



Top & bottom shelves utilize Double Rivet Beams to form a rigid structure



Intermediate Shelves feature Single Rivet Beams for attractive Low Profile Design



Single Rivet Beams allow decking to sit flush with top of beams



Units can be connected using interlocking Tie Plates.
See page 12 for pricing.





Particle Board Decking

- Low cost durable decking
- 1/2" thick



Laminated Decking

- Durable Laminated particle board
- Smooth shelf surface
- Improves appearance
- 1/2" thick



Wire Mesh Decking

- 3/4" x 5" wire openings
- Small openings in mesh ideal for storage of small and medium packages/cartons
- Durable black powder coated finish

Units are priced in our most popular height of 7', but can be ordered in heights ranging from 3' to 12' to fit your specific needs. Regular Load Capacity units are priced complete with 1/2" particle board decking. Units now available with wire mesh decking. Units come standard with 5 shelves. Customize units by ordering additional shelves that adjust on 1 1/2" centers. Individual units can be connected using interlocking Tie Plates. Tie Plates sold separately (see page 12). All units come complete with either particle board decking, laminated board decking, or wire mesh decking.

Model Number Code: **2A3-7218-84 W/L/M**

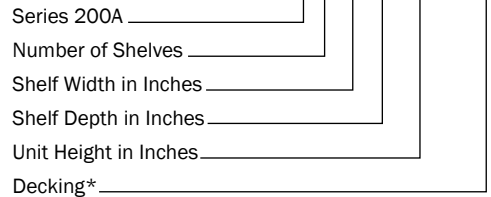

*W - 1/2" Particle Board

*L - 1/2" Laminated Board

*M - Wire Mesh

Size W x D	Shelf Capacity	Particle Board Decking				Laminated Board Decking				Wire Mesh Decking			
		5 Shelf Unit	Price	Extra Shelf	Price	5 Shelf Unit	Price	Extra Shelf	Price	5 Shelf Unit	Price	Extra Shelf	Price
		7' Height				7' Height				7' Height			
36" x 12"	300	2A5-3612-84W	110.51	2AX1-3612-W	10.55	2A5-3612-84L	130.20	2AX1-3612-L	14.49	2A5-3612-84M	127.47	2AX1-3612-M	13.94
36" x 18"	300	2A5-3618-84W	123.06	2AX1-3618-W	12.52	2A5-3618-84L	152.62	2AX1-3618-L	18.43	2A5-3618-84M	145.90	2AX1-3618-M	17.08
36" x 24"	300	2A5-3624-84W	135.57	2AX1-3624-W	14.48	2A5-3624-84L	174.99	2AX1-3624-L	22.37	2A5-3624-84M	164.55	2AX1-3624-M	20.28
36" x 30"	250	2A5-3630-84W	148.68	2AX1-3630-W	16.46	2A5-3630-84L	197.87	2AX1-3630-L	26.30	N/A	N/A	N/A	N/A
42" x 12"	225	2A5-4212-84W	120.28	2AX1-4212-W	12.38	2A5-4212-84L	143.27	2AX1-4212-L	16.98	N/A	N/A	N/A	N/A
42" x 18"	225	2A5-4218-84W	134.45	2AX1-4218-W	14.67	2A5-4218-84L	169.00	2AX1-4218-L	21.58	N/A	N/A	N/A	N/A
42" x 24"	225	2A5-4224-84W	148.59	2AX1-4224-W	16.96	2A5-4224-84L	194.63	2AX1-4224-L	26.17	N/A	N/A	N/A	N/A
42" x 30"	225	2A5-4230-84W	163.22	2AX1-4230-W	19.25	2A5-4230-84L	220.82	2AX1-4230-L	30.77	N/A	N/A	N/A	N/A
42" x 36"	225	2A5-4236-84W	197.67	2AX1-4236-W	28.16	2A5-4236-84L	266.71	2AX1-4236-L	41.97	N/A	N/A	N/A	N/A
48" x 12"	225	2A5-4812-84W	127.95	2AX1-4812-W	13.50	2A5-4812-84L	154.20	2AX1-4812-L	18.75	2A5-4812-84M	151.00	2AX1-4812-M	18.11
48" x 18"	225	2A5-4818-84W	143.76	2AX1-4818-W	16.12	2A5-4818-84L	183.18	2AX1-4818-L	24.00	2A5-4818-84M	175.31	2AX1-4818-M	22.43
48" x 24"	225	2A5-4824-84W	159.52	2AX1-4824-W	18.73	2A5-4824-84L	212.12	2AX1-4824-L	29.25	2A5-4824-84M	199.52	2AX1-4824-M	26.73
48" x 30"	225	2A5-4830-84W	175.83	2AX1-4830-W	21.36	2A5-4830-84L	241.56	2AX1-4830-L	34.50	N/A	N/A	N/A	N/A
48" x 36"	225	2A5-4836-84W	211.91	2AX1-4836-W	30.60	2A5-4836-84L	290.77	2AX1-4836-L	46.37	N/A	N/A	N/A	N/A
60" x 12"	150	2A5-6012-84W	174.80	2AX1-6012-W	25.07	2A5-6012-84L	207.67	2AX1-6012-L	31.65	N/A	N/A	N/A	N/A
60" x 18"	150	2A5-6018-84W	193.76	2AX1-6018-W	28.32	2A5-6018-84L	243.21	2AX1-6018-L	38.21	N/A	N/A	N/A	N/A
60" x 24"	150	2A5-6024-84W	212.98	2AX1-6024-W	31.63	2A5-6024-84L	278.71	2AX1-6024-L	44.77	N/A	N/A	N/A	N/A
60" x 30"	150	2A5-6030-84W	232.55	2AX1-6030-W	34.90	2A5-6030-84L	314.72	2AX1-6030-L	51.33	N/A	N/A	N/A	N/A
60" x 36"	150	2A5-6036-84W	271.83	2AX1-6036-W	44.78	2A5-6036-84L	370.48	2AX1-6036-L	64.51	N/A	N/A	N/A	N/A

Series 100B Features 1/2" Particle Board Decking

The Series 100B shelving is an attractive and low cost solution for medium to heavy load applications. Our newly designed Double Rivet Z-Beam allows the decking to sit below the lip of the beam for a more attractive look. Units are priced complete with 3 shelves. Choose between particle board, laminated board, or wire mesh decking. Customize your units by adding extra shelves. Units are priced in our most popular height of 7', but can be ordered in heights ranging from 3' to 12' to fit your specific needs. Steel color: Gray. Wire deck color: Black. All units come complete with either particle board decking, laminated board decking, or wire mesh decking.



Particle Board Decking

- Low cost durable decking
- 1/2" thick



Laminated Decking

- Durable Laminated particle board
- Smooth shelf surface
- Improves appearance
- 1/2" thick



Wire Mesh Decking

- 3/4" x 5" wire openings
- Small openings in mesh ideal for storage of small and medium packages/cartons
- Durable black powder coated finish

Model Number Code: **1B3-7218-84W / L / M**

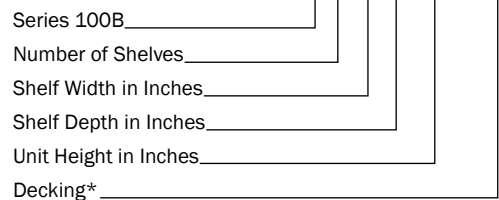

*W - 1/2" Particle Board
 *L - 1/2" Laminated Board
 *M - Wire Mesh

Size W x D	Shelf Capacity	Particle Board Decking				Laminated Board Decking				Wire Mesh Decking			
		3 Shelf Unit	Price	Extra Shelf	Price	3 Shelf Unit	Price	Extra Shelf	Price	3 Shelf Unit	Price	Extra Shelf	Price
7' Height													
36" x 12"	500	1B3-3612-84W	89.18	1BX1-3612-W	15.49	1B3-3612-84L	100.99	1BX1-3612-L	19.43	1B3-3612-84M	99.35	1BX1-3612-M	18.88
36" x 18"	500	1B3-3618-84W	97.90	1BX1-3618-W	18.40	1B3-3618-84L	115.64	1BX1-3618-L	24.31	1B3-3618-84M	111.60	1BX1-3618-M	22.96
36" x 24"	500	1B3-3624-84W	107.76	1BX1-3624-W	21.68	1B3-3624-84L	131.42	1BX1-3624-L	29.57	1B3-3624-84M	125.15	1BX1-3624-M	27.48
48" x 12"	500	1B3-4812-84W	98.91	1BX1-4812-W	18.73	1B3-4812-84L	114.66	1BX1-4812-L	23.98	1B3-4812-84M	112.74	1BX1-4812-M	23.34
48" x 18"	500	1B3-4818-84W	109.59	1BX1-4818-W	22.29	1B3-4818-84L	133.25	1BX1-4818-L	30.18	1B3-4818-84M	128.52	1BX1-4818-M	28.60
48" x 24"	500	1B3-4824-84W	121.40	1BX1-4824-W	26.23	1B3-4824-84L	152.96	1BX1-4824-L	36.75	1B3-4824-84M	145.40	1BX1-4824-M	34.23
48" x 36"	500	1B3-4836-84W	145.09	1BX1-4836-W	34.13	1B3-4836-84L	192.40	1BX1-4836-L	49.90	N/A	N/A	N/A	N/A

Series 100A Features 1/2" Particle Board Decking

Series 100A shelving features our Double Rivet Z-Beam for the top and bottom shelves which provides for a more attractive look because the decking rests inside the beam. This industrial grade shelving is designed for medium to light duty applications and is an excellent alternative to traditional all steel shelving and standard boltless shelving. Available with particle board decking, laminated board decking, or wire mesh decking. Shelves are adjustable in 1 1/2" increments. Units are priced in our most popular height of 7', but can be ordered in heights ranging from 3' to 12' to fit your specific needs. Easy to assemble. Units are accessible from all four sides. Individual units can be connected using interlocking Tie Plates. Tie Plates sold separately (see page 12). Steel color: Gray. Wire decking color: Black. All units come complete with either particle board decking, laminated board decking, or wire mesh decking.



Particle Board Decking

- Low cost durable decking
- 1/2" thick



Laminated Decking

- Durable Laminated particle board
- Smooth shelf surface
- Improves appearance
- 1/2" thick



Wire Mesh Decking

- 3/4" x 5" wire openings
- Small openings in mesh ideal for storage of small and medium packages/cartons
- Durable black powder coated finish

Model Number Code:

1AH5-4824-84W/L/M

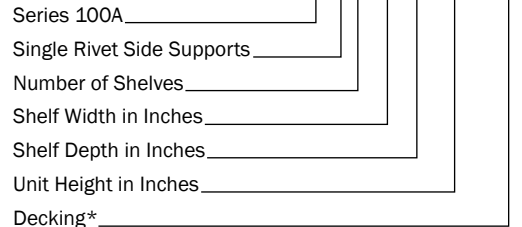

- *W - 1/2" Particle Board
- *L - 1/2" Laminated Board
- *M - Wire Mesh

Size W x D	Shelf Capacity	Particle Board Decking				Laminated Board Decking				Wire Mesh Decking			
		5 Shelf Unit	Price	Extra Shelf	Price	5 Shelf Unit	Price	Extra Shelf	Price	5 Shelf Unit	Price	Extra Shelf	Price
		7' Height				7' Height				7' Height			
36" x 12"	300	1A5-3612-84W	105.35	1AX1-3612-W	10.55	1A5-3612-84L	125.03	1AX1-3612-L	14.49	1A5-3612-84M	122.30	1AX1-3612-M	13.94
36" x 18"	300	1A5-3618-84W	117.05	1AX1-3618-W	12.52	1A5-3618-84L	146.61	1AX1-3618-L	18.43	1A5-3618-84M	139.89	1AX1-3618-M	17.08
36" x 24"	300	1A5-3624-84W	129.52	1AX1-3624-W	14.48	1A5-3624-84L	168.95	1AX1-3624-L	22.37	1A5-3624-84M	158.50	1AX1-3624-M	20.28
48" x 12"	225	1A5-4812-84W	120.69	1AX1-4812-W	13.50	1A5-4812-84L	146.94	1AX1-4812-L	18.75	1A5-4812-84M	143.73	1AX1-4812-M	18.11
48" x 18"	225	1A5-4818-84W	135.65	1AX1-4818-W	16.12	1A5-4818-84L	175.08	1AX1-4818-L	24.00	1A5-4818-84M	167.20	1AX1-4818-M	22.43
48" x 24"	225	1A5-4824-84W	151.37	1AX1-4824-W	18.73	1A5-4824-84L	203.97	1AX1-4824-L	29.25	1A5-4824-84M	191.37	1AX1-4824-M	26.73
48" x 36"	225	1A5-4836-84W	202.76	1AX1-4836-W	30.60	1A5-4836-84L	281.61	1AX1-4836-L	46.37	N/A	N/A	N/A	N/A
36" x 12"	500	1AH5-3612-84W	128.28	1AXH1-3612-W	18.20	1AH5-3612-84L	147.97	1AXH1-3612-L	22.13	1AH5-3612-84M	145.24	1AXH1-3612-M	21.59
36" x 18"	500	1AH5-3618-84W	143.51	1AXH1-3618-W	21.34	1AH5-3618-84L	173.07	1AXH1-3618-L	27.25	1AH5-3618-84M	166.35	1AXH1-3618-M	25.90
36" x 24"	500	1AH5-3624-84W	158.50	1AXH1-3624-W	24.14	1AH5-3624-84L	197.93	1AXH1-3624-L	32.03	1AH5-3624-84M	187.48	1AXH1-3624-M	29.94
48" x 12"	375	1AH5-4812-84W	149.73	1AXH1-4812-W	23.18	1AH5-4812-84L	175.98	1AXH1-4812-L	28.43	1AH5-4812-84M	172.78	1AXH1-4812-M	27.79
48" x 18"	375	1AH5-4818-84W	168.22	1AXH1-4818-W	26.97	1AH5-4818-84L	207.65	1AXH1-4818-L	34.86	1AH5-4818-84M	199.77	1AXH1-4818-M	33.29
48" x 24"	375	1AH5-4824-84W	186.46	1AXH1-4824-W	30.43	1AH5-4824-84L	239.06	1AXH1-4824-L	40.95	1AH5-4824-84M	226.46	1AXH1-4824-M	38.43
48" x 36"	375	1AH5-4836-84W	223.99	1AXH1-4836-W	37.67	1AH5-4836-84L	302.84	1AXH1-4836-L	53.45	N/A	N/A	N/A	N/A



Upright Posts

- » 14 gauge steel construction

Height	Model Number	Price Each
Regular Duty - 1½"W x 1½"D		
2.5'	200-P2.5	3.81
3'	200-P3	4.57
4'	200-P4	6.11
5'	200-P5	7.64
6'	200-P6	9.16
7'	200-P7	10.68
8'	200-P8	12.21
9'	200-P9	13.74
10'	200-P10	15.27
12'	200-P12	18.32
Heavy Duty - 1¾"W x 1¾"D		
7'	200-PH7	12.81
8'	200-PH8	14.65
10'	200-PH10	18.32
12'	200-PH12	22.01
15'	200-PH15	27.93



Single Rivet Beams

- » 1" Height

Length	Model Number	Price Each
Regular Duty - 14 gauge steel		
12"	200-SR12	1.30
18"	200-SR18	1.89
24"	200-SR24	2.31
30"	200-SR30	3.00
36"	200-SR36	3.31
42"	200-SR42	3.90
48"	200-SR48	4.13
Heavy Duty - 11 gauge steel		
36"	200-SRH36	5.83
48"	200-SRH48	7.67
60"	200-SRH60	9.26



Double Rivet Beams

- » 16 gauge steel (12" - 48" beams)
- » 14 gauge steel (60" - 96" beams)
- » 2¾" Height

Length	Model Number	Price Each
12"	200-DR12	2.07
15"	200-DR15	2.36
18"	200-DR18	2.75
24"	200-DR24	3.42
30"	200-DR30	4.22
36"	200-DR36	5.00
42"	200-DR42	5.74
48"	200-DR48	6.49
60"	200-DR60	8.87
69"	200-DR69	10.48
72"	200-DR72	10.48
84"	200-DR84	12.24
96"	200-DR96	13.83



Double Rivet Channel Beams

- » 2¾" Height

Length	Model Number	Price Each
Regular Duty - 14 gauge steel		
72"	200-DC72	13.77
96"	200-DC96	18.34
Heavy Duty - 11 gauge steel		
72"	200-DCH72	19.91
96"	200-DCH96	26.79

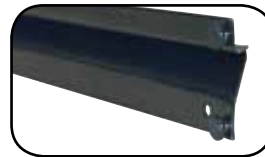

Double Rivet Z-Beams

- » 16 gauge steel (12" - 48" beams)
- » 2¾" Height

Length	Model Number	Price Each
12"	200-DRZ12	1.66
18"	200-DRZ18	2.13
24"	200-DRZ24	2.79
36"	200-DRZ36	4.12
48"	200-DRZ48	5.08



Shelf Deck Supports

- » 16 gauge steel
- » 2½" Height
- » Adds capacity to shelf when bolted between double rivet beams

Length	Model Number	Price Each
12"	200-SDS12	3.57
15"	200-SDS15	3.72
18"	200-SDS18	3.85
24"	200-SDS24	4.63
30"	200-SDS30	5.12
36"	200-SDS36	5.80
48"	200-SDS48	7.46



Heavy Duty Shelf Deck Supports

- » Provides extra support for wire decking
- » Designed specifically for use with our wire mesh decking

Length	Model Number	Price Each
18"	200-SDSHD18	5.10
24"	200-SDSHD24	6.17
36"	200-SDSHD36	7.73
48"	200-SDSHD48	9.81



Tie Plates

- » Connect shelving units side by side
- » Use one tie plate front and back to connect 2½' - 3' posts
- » Use two tie plates front and back to connect 4' - 7' posts
- » Use three tie plates front and back to connect 8' - 12' posts

Model Number	Price Each
200-TP	0.96

Particle Board Decking for Boltless Shelving

Provides a strong and durable shelf surface. 1/2" particle board decking is recommended for standard to light-duty applications. 3/4" decking is ideal for heavy-duty applications. Decking provides smooth work-surface and enhances the appearance of shelving



Shelving Label Holders

- » Durable and clear plastic will not crack, peel, fade or fall off
- » Insert paper may be reversed, re-marked and re-inserted when changes are required
- » Inkjet/Laser paper inserts included



H x W	Qty.	Model Number	Price Each
Adhesive			
3/4" x 6"	12	200-L231	29.25
1" x 6"	12	200-L211	33.75
2" x 6"	12	200-L251	44.44
Magnetic			
1" x 6"	12	200-M211	36.23
2 1/2" x 6"	12	200-M261	71.33

Size W x D	1/2" Particle Board		3/4" Particle Board		1/2" Laminated Board		3/4" Laminated Board	
	Model Number	Price	Model Number	Price	Model Number	Price	Model Number	Price
36" x 12"	240-013612	3.94	240-023612	5.49	240-033612	7.88	240-083612	9.45
36" x 18"	240-013618	5.90	240-023618	8.25	240-033618	11.81	240-083618	14.18
36" x 24"	240-013624	7.86	240-023624	11.01	240-033624	15.75	240-083624	18.90
36" x 36"	240-013636	11.80	240-023636	16.51	240-033636	23.63	240-083636	28.35
42" x 15"	240-014215	5.74	240-024215	8.03	240-034215	11.49	240-084215	13.79
42" x 18"	240-014218	6.89	240-024218	9.65	240-034218	13.79	240-084218	16.54
42" x 24"	240-014224	9.19	240-024224	12.86	240-034224	18.38	240-084224	22.05
42" x 30"	240-014230	11.49	240-024230	16.08	240-034230	22.97	240-084230	27.56
48" x 12"	240-014812	5.25	240-024812	7.34	240-034812	10.50	240-084812	12.60
48" x 18"	240-014818	7.86	240-024818	11.01	240-034818	15.75	240-084818	18.90
48" x 24"	240-014824	10.48	240-024824	14.67	240-034824	21.00	240-084824	25.20
48" x 30"	240-014830	13.10	240-024830	18.34	240-034830	26.25	240-084830	31.50
48" x 36"	240-014836	15.73	240-024836	22.02	240-034836	31.50	240-084836	37.80
48" x 42"	240-014842	18.38	240-024842	25.73	240-034842	36.75	240-084842	44.10
48" x 48"	240-014848	20.97	240-024848	29.36	240-034848	42.00	240-084848	50.40
60" x 12"	240-016012	6.55	240-026012	9.17	240-036012	13.13	240-086012	15.75
60" x 18"	240-016018	9.80	240-026018	13.77	240-036018	19.69	240-086018	23.63
60" x 24"	240-016024	13.10	240-026024	18.34	240-036024	26.25	240-086024	31.50
60" x 30"	240-016030	16.38	240-026030	22.94	240-036030	32.81	240-086030	39.38
60" x 36"	240-016036	19.65	240-026036	27.51	240-036036	39.38	240-086036	47.25
60" x 42"	240-016042	22.97	240-026042	32.16	240-036042	45.94	240-086042	55.13
60" x 48"	240-016048	26.21	240-026048	36.70	240-036048	52.50	240-086048	63.00
69" x 15"	240-016915	9.42	240-026915	13.28	240-036915	18.87	240-086915	22.64
69" x 30"	240-016930	18.85	240-026930	26.38	240-036930	37.74	240-086930	45.29
72" x 12"	240-017212	7.86	240-027212	11.01	240-037212	15.75	240-087212	18.90
72" x 18"	240-017218	11.80	240-027218	16.51	240-037218	23.63	240-087218	28.35
72" x 24"	240-017224	15.73	240-027224	22.02	240-037224	31.50	240-087224	37.80
72" x 30"	240-017230	19.65	240-027230	27.51	240-037230	39.38	240-087230	47.25
72" x 36"	240-017236	23.58	240-027236	33.02	240-037236	47.25	240-087236	56.70
72" x 42"	240-017242	27.56	240-027242	38.59	240-037242	55.13	240-087242	66.15
72" x 48"	240-017248	31.45	240-027248	44.03	240-037248	63.00	240-087248	75.60
84" x 12"	240-018412	9.17	240-028412	12.84	240-038412	18.38	240-088412	22.05
84" x 18"	240-018418	13.77	240-028418	19.27	240-038418	27.56	240-088418	33.08
84" x 24"	240-018424	18.34	240-028424	25.68	240-038424	36.75	240-088424	44.10
84" x 30"	240-018430	22.94	240-028430	32.11	240-038430	45.94	240-088430	55.13
84" x 36"	240-018436	27.51	240-028436	38.52	240-038436	55.13	240-088436	66.15
84" x 42"	240-018442	32.16	240-028442	45.02	240-038442	64.31	240-088442	77.18
84" x 48"	240-018448	36.70	240-028448	51.36	240-038448	73.50	240-088448	88.20
96" x 12"	240-019612	10.48	240-029612	14.67	240-039612	21.00	240-089612	25.20
96" x 18"	240-019618	15.73	240-029618	22.02	240-039618	31.50	240-089618	37.80
96" x 24"	240-019624	20.97	240-029624	29.36	240-039624	42.00	240-089624	50.40
96" x 30"	240-019630	26.21	240-029630	36.70	240-039630	52.50	240-089630	63.00
96" x 36"	240-019636	31.45	240-029636	44.03	240-039636	63.00	240-089636	75.60
96" x 42"	240-019642	36.75	240-029642	51.45	240-039642	73.50	240-089642	88.20
96" x 48"	240-019648	41.93	240-029648	58.71	240-039648	84.00	240-089648	100.80

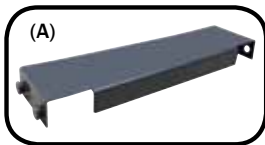

Description	Model Number	Price Each
(A) Wall Tie	200-WT09	3.59
(B) Left Foot Plate	200-FPL	1.87
(C) Double Foot Plate	200-FPD	2.45
(D) Right Foot Plate	200-FPR	1.87

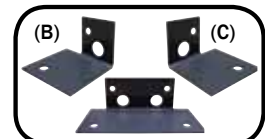

(D)

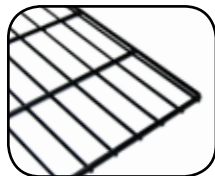

100A, 100B, 200A Wire Decking

- » Heavy duty 5 gauge construction
- » 3/4" x 5" wire openings
- » Durable black powder coated finish

Size W x D	Model Number	Price Each
36" x 12"	200-WMDB3612	7.33
36" x 18"	200-WMDB3618	10.47
36" x 24"	200-WMDB3624	13.66
48" x 12"	200-WMDB4812	9.86
48" x 18"	200-WMDB4818	14.18
48" x 24"	200-WMDB4824	18.48

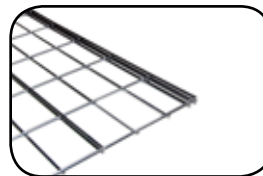

200B Wire Decking

- » Heavy duty 5 gauge construction
- » 2" x 4" wire openings
- » Durable silver powder coated finish

Size W x D	Model Number	Price Each
36" x 18"	200-WMHS3618	8.63
36" x 24"	200-WMHS3624	11.51
36" x 36"	200-WMHS3636	15.38
36" x 48"	200-WMHS3648	23.04
48" x 18"	200-WMHS4818	12.35
48" x 24"	200-WMHS4824	15.36
48" x 36"	200-WMHS4836	23.04
48" x 48"	200-WMHS4848	30.71

Pallet Rack

Regular Duty and Heavy Duty pallet rack features 3" x 3" columns and 5" x 8" seismic base plates. Regular duty uprights are constructed of 16 gauge steel and provide 16,100 lbs. capacity per upright. The heavy duty uprights feature a 23,300 lbs. capacity and are constructed from 14 gauge steel (regular and heavy duty capacities are based upon a maximum shelf spacing of 36").

The bolt together design of the pallet rack uprights provides a lower cost of ownership because components can be easily replaced when damaged during use. Traditional welded uprights would require replacement of the entire upright at a more significant cost. Step Load Beams feature a removable safety clip that allows for easy replacement of damaged clips. Racks are designed for use with a forklift (or other hydraulic or electrical lift) or for heavy duty hand stacking. Buy pallet rack uprights, beams, wire mesh decking and accessories separately or in complete "starter" and "add-on" units.



Popular tear drop design insures interchangeability with most major pallet rack manufacturers: Interlake (Original Style), Space Rack, USP, Lodi Metal-Tech, Steek King and Husky.

Uprights

Featuring a 3" x 3" standard column design and 5" x 8" base plate. Regular duty uprights are constructed of 16 gauge steel with a 16,100 lbs. capacity. Heavy duty uprights feature 14 gauge steel construction with a capacity of 23,300 lbs. (regular and heavy duty capacities based upon 36" maximum shelf spacing). Uprights utilize a bolt together design for easy component replacement. Beams can be adjusted every 2". Uprights can be shipped assembled for an additional charge per upright. Color: Light green.

Regular Duty Upright



Heavy Duty Upright

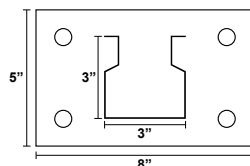
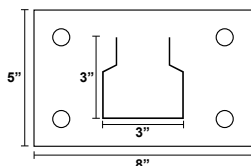

H x D	Unassembled		Assembled	
	Model Number	Price Each	Model Number	Price Each
Regular Duty Uprights				
8' x 3.0'	IU36096	85.04	IU36096A	93.54
10' x 3.0'	IU36120	100.58	IU36120A	110.63
12' x 3.0'	IU36144	124.23	IU36144A	136.65
8' x 3.5'	IU42096	89.63	IU42096A	98.60
10' x 3.5'	IU42120	105.05	IU42120A	115.55
12' x 3.5'	IU42144	130.49	IU42144A	143.55
8' x 4.0'	IU48096	94.33	IU48096A	103.77
10' x 4.0'	IU48120	109.57	IU48120A	120.52
12' x 4.0'	IU48144	136.88	IU48144A	150.56
Heavy Duty Uprights				
10' x 3.0'	IUH36120	155.24	IUH36120A	170.77
12' x 3.0'	IUH36144	180.89	IUH36144A	198.99
16' x 3.0'	IUH36192	232.49	IUH36192A	255.73
18' x 3.0'	IUH36216	257.13	IUH36216A	282.85
20' x 3.0'	IUH36240	284.10	IUH36240A	312.51
10' x 3.5'	IUH42120	158.09	IUH42120A	173.89
12' x 3.5'	IUH42144	184.09	IUH42144A	202.50
16' x 3.5'	IUH42192	233.86	IUH42192A	257.25
18' x 3.5'	IUH42216	262.33	IUH42216A	288.56
20' x 3.5'	IUH42240	285.14	IUH42240A	313.66
10' x 4.0'	IUH48120	161.35	IUH48120A	177.49
12' x 4.0'	IUH48144	187.70	IUH48144A	206.47
16' x 4.0'	IUH48192	242.08	IUH48192A	266.29
18' x 4.0'	IUH48216	267.53	IUH48216A	294.28
20' x 4.0'	IUH48240	295.27	IUH48240A	324.80

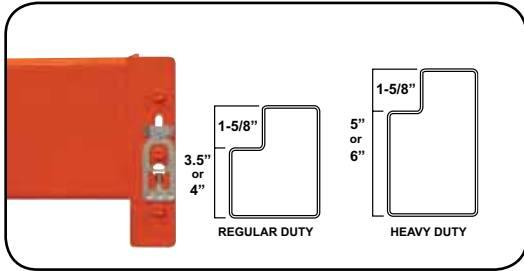

Step Load Beams

Deluxe form beams feature an improved safety clip which can be easily replaced and prevents the beam from detaching from the upright. Beams are interchangeable with most major pallet rack manufacturers. Beam length is measured by clear span between uprights. Beam capacities are based on an evenly distributed load. Sold per beam. Two beams are required to create a shelf. Color:

H x L	Cap. Per Pair	Model Number	Price Each
Regular Duty			
3.5" x 8'	3,420	215-IB35096	50.51
4.0" x 8'	4,400	215-IB40096	54.79
4.0" x 9'	3,680	215-IB40108	60.97
4.0" x 10'	3,020	215-IB40120	67.20
Heavy Duty			
5.0" x 8'	6,100	215-IB50096	62.75
5.0" x 9'	5,470	215-IB50108	69.94
5.0" x 10'	4,960	215-IB50120	77.11
5.0" x 12'	3,610	215-IB50144	91.46
6.0" x 12'	5,580	215-IB60144	115.61

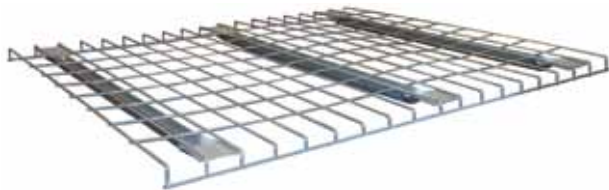

Wire Mesh Decking

Open wire construction reduces dust build-up and allows free light and air circulation, increases sprinkler effectiveness and improves visibility. Constructed of 4 gauge wire and 14 gauge flared channels. Featuring a durable powder coated finish and 2½" x 4½" wire spacing. Each level of decking consists of two or more smaller

D x W	Model Number	Price Each
36" x 46"	215-DF3646	41.97
36" x 58"	215-DF3658	58.62
42" x 46"	215-DF4246	49.52
42" x 58"	215-DF4258	68.57
48" x 46"	215-DF4846	59.50
48" x 58"	215-DF4858	81.87



Bay Dividers

Organize material vertically with these easy to install bay dividers. Designed to fit over our 3.5", 4" and 5" beams. No hardware required. Pre-punched holes are available for permanent mounting.

Model Number	Price Each
215-ID01	92.07



Safety Supports

Use Safety Supports as front to back members to support pallets or wood decking. Steel supports are recommended for medium and heavy duty applications.

Upright Depth	Model Number	Price Each
3.0'	215-USS36	12.57
3.5'	215-USS42	14.55
4.0'	215-USS48	15.92

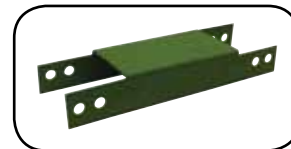

Row Spacers

Used to connect rows of pallet rack (back to back). Spacers increase stability and maintain consistent spacing between rows.

Spacer Length	Model Number	Price Each
6"	215-IR06	6.42
12"	215-IR12	9.69
18"	215-IR18	12.98



Post Frame Guards

Avoid damage to valuable rack columns. These solid steel guards withstand impacts with heavy duty construction. Features high visibility yellow powder coated finish.

Model Number	Price Each
215-ICP24	35.67



Label Holders

Extra large for pallet rack applications. Self-adhesive or magnetic label holder allows for simple label relocation. Side loading. Includes Inkjet/Laser compatible white inserts with instructions. Bar code compatible.

H x W	Qty.	Adhesive		Magnetic	
		Model Number	Price Each	Model Number	Price Each
3" x 5"	50	215-L335	66.94	215-L335M	92.25
4" x 6"	50	215-L346	78.75	215-L346M	115.31

How to Order

Uprights

1. Upright Capacity

Calculate upright capacity by adding total weight of goods being stored. Do not include goods being placed on floor.

2. Upright Height

Step #1 - Calculate load height by adding height of palletized goods plus 6" for clearance between palletized goods and the beam supporting the next level.

Step #2 - Add height of beam (either 3.5", 4", 5" or 6")

Step #3 - Multiply the sum of Step #1 and Step #2 by the number of load levels.

Note: Top load height need not be counted in determining upright height.

3. Upright Depth

Deduct 6" from pallet depth to allow 3" pallet overhang front and rear. For example: a 48" deep pallet would require a 42" deep upright.

Load Beams

1. Beam Length

Multiply pallet width by the number of pallets being stored on each level plus 12" for clearance. For example: two 48" wide pallets would require 108" long beams.

2. Beam Capacity

Determine capacity by multiplying the number of pallets per pair of load beams by the weight of each pallet.

Upright D x W	Beam Height	Cap. Per Pair	Starter Units		Add-On Units	
			Model Number	Price Each	Model Number	Price Each
Regular Duty - 8' High						
36" x 96"	3.5"	3,420	IA36096-35096	389.11	IB36096-35096	295.56
36" x 96"	4"	4,400	IA36096-40096	406.25	IB36096-40096	312.70
36" x 96"	5"	6,100	IA36096-50096	438.08	IB36096-50096	344.54
36" x 108"	4"	3,680	IA36096-40108	430.98	IB36096-40108	337.44
36" x 108"	5"	5,470	IA36096-50108	466.85	IB36096-50108	373.31
36" x 120"	4"	3,020	IA36096-40120	455.89	IB36096-40120	362.34
36" x 120"	5"	4,960	IA36096-50120	495.54	IB36096-50120	401.99
36" x 144"	5"	3,610	IA36096-50144	552.91	IB36096-50144	459.36
36" x 144"	6"	5,580	IA36096-60144	649.51	IB36096-60144	555.96
42" x 96"	3.5"	3,420	IA42096-35096	399.21	IB42096-35096	300.62
42" x 96"	4"	4,400	IA42096-40096	416.35	IB42096-40096	317.75
42" x 96"	5"	6,100	IA42096-50096	448.18	IB42096-50096	349.59
42" x 108"	4"	3,680	IA42096-40108	441.08	IB42096-40108	342.49
42" x 108"	5"	5,470	IA42096-50108	476.95	IB42096-50108	378.36
42" x 120"	4"	3,020	IA42096-40120	465.99	IB42096-40120	367.40
42" x 120"	5"	4,960	IA42096-50120	505.64	IB42096-50120	407.04
42" x 144"	5"	3,610	IA42096-50144	563.01	IB42096-50144	464.42
42" x 144"	6"	5,580	IA42096-60144	659.61	IB42096-60144	561.02
48" x 96"	3.5"	3,420	IA48096-35096	405.36	IB48096-35096	303.69
48" x 96"	4"	4,400	IA48096-40096	426.70	IB48096-40096	322.93
48" x 96"	5"	6,100	IA48096-50096	458.54	IB48096-50096	354.76
48" x 108"	4"	3,680	IA48096-40108	451.44	IB48096-40108	347.67
48" x 108"	5"	5,470	IA48096-50108	487.31	IB48096-50108	383.53
48" x 120"	4"	3,020	IA48096-40120	476.34	IB48096-40120	372.57
48" x 120"	5"	4,960	IA48096-50120	515.99	IB48096-50120	412.22
48" x 144"	5"	3,610	IA48096-50144	573.36	IB48096-50144	469.59
48" x 144"	6"	5,580	IA48096-60144	669.96	IB48096-60144	566.19

Upright D x W	Beam Height	Cap. Per Pair	Starter Units		Add-On Units		Starter Units		Add-On Units	
			Model Number	Price Each	Model Number	Price Each	Model Number	Price Each	Model Number	Price Each
Regular Duty - 10' High										
36" x 96"	3.5"	3,420	IA36120-35096	423.28	IB36120-35096	312.65	IA36144-35096	475.31	IB36144-35096	338.67
36" x 96"	4"	4,400	IA36120-40096	440.41	IB36120-40096	329.78	IA36144-40096	492.45	IB36144-40096	355.80
36" x 96"	5"	6,100	IA36120-50096	472.25	IB36120-50096	361.62	IA36144-50096	524.29	IB36144-50096	387.64
36" x 108"	4"	3,680	IA36120-40108	465.15	IB36120-40108	354.52	IA36144-40108	517.19	IB36144-40108	380.54
36" x 108"	5"	5,470	IA36120-50108	501.02	IB36120-50108	390.39	IA36144-50108	553.06	IB36144-50108	416.41
36" x 120"	4"	3,020	IA36120-40120	490.06	IB36120-40120	379.43	IA36144-40120	542.09	IB36144-40120	405.45
36" x 120"	5"	4,960	IA36120-50120	529.70	IB36120-50120	419.08	IA36144-50120	581.74	IB36144-50120	445.10
36" x 144"	5"	3,610	IA36120-50144	587.08	IB36120-50144	476.45	IA36144-50144	639.11	IB36144-50144	502.47
36" x 144"	6"	5,580	IA36120-60144	683.68	IB36120-60144	573.05	IA36144-60144	735.71	IB36144-60144	599.07
42" x 96"	3.5"	3,420	IA42120-35096	433.13	IB42120-35096	317.57	IA42144-35096	489.11	IB42144-35096	345.57
42" x 96"	4"	4,400	IA42120-40096	450.26	IB42120-40096	334.71	IA42144-40096	506.25	IB42144-40096	362.70
42" x 96"	5"	6,100	IA42120-50096	482.10	IB42120-50096	366.54	IA42144-50096	538.08	IB42144-50096	394.54
42" x 108"	4"	3,680	IA42120-40108	475.00	IB42120-40108	359.45	IA42144-40108	530.99	IB42144-40108	387.44
42" x 108"	5"	5,470	IA42120-50108	510.87	IB42120-50108	395.31	IA42144-50108	566.85	IB42144-50108	423.31
42" x 120"	4"	3,020	IA42120-40120	499.91	IB42120-40120	384.35	IA42144-40120	555.89	IB42144-40120	412.35
42" x 120"	5"	4,960	IA42120-50120	539.55	IB42120-50120	424.00	IA42144-50120	595.54	IB42144-50120	451.99
42" x 144"	5"	3,610	IA42120-50144	596.93	IB42120-50144	481.37	IA42144-50144	652.91	IB42144-50144	509.37
42" x 144"	6"	5,580	IA42120-60144	693.53	IB42120-60144	577.97	IA42144-60144	749.51	IB42144-60144	605.97
48" x 96"	3.5"	3,420	IA48120-35096	443.06	IB48120-35096	322.54	IA48144-35096	503.14	IB48144-35096	352.58
48" x 96"	4"	4,400	IA48120-40096	460.19	IB48120-40096	339.68	IA48144-40096	520.28	IB48144-40096	369.72
48" x 96"	5"	6,100	IA48120-50096	492.03	IB48120-50096	371.51	IA48144-50096	552.11	IB48144-50096	401.55
48" x 108"	4"	3,680	IA48120-40108	484.93	IB48120-40108	364.41	IA48144-40108	545.01	IB48144-40108	394.45
48" x 108"	5"	5,470	IA48120-50108	520.80	IB48120-50108	400.28	IA48144-50108	580.88	IB48144-50108	430.32
48" x 120"	4"	3,020	IA48120-40120	509.84	IB48120-40120	389.32	IA48144-40120	569.92	IB48144-40120	419.36
48" x 120"	5"	4,960	IA48120-50120	549.49	IB48120-50120	428.97	IA48144-50120	609.57	IB48144-50120	459.01
48" x 144"	5"	3,610	IA48120-50144	606.86	IB48120-50144	486.34	IA48144-50144	666.94	IB48144-50144	516.38
48" x 144"	6"	5,580	IA48120-60144	703.46	IB48120-60144	582.94	IA48144-60144	763.54	IB48144-60144	612.98

Uprights come pre-assembled, upright assembly included in price listed below

Pallet Rack Units - Heavy Duty

Upright D x W	Beam Height	Cap. Per Pair	Starter Units		Add-On Units		Starter Units		Add-On Units		
			Model Number	Price Each	Model Number	Price Each	Model Number	Price Each	Model Number	Price Each	
Heavy Duty - 10' High						Heavy Duty - 12' High					
36" x 96"	3.5"	3,420	IK36120-35096	543.56	IM36120-35096	372.79	IK36144-35096	599.99	IM36144-35096	401.01	
36" x 96"	4"	4,400	IK36120-40096	560.70	IM36120-40096	389.93	IK36144-40096	617.13	IM36144-40096	418.14	
36" x 96"	5"	6,100	IK36120-50096	592.54	IM36120-50096	421.76	IK36144-50096	648.96	IM36144-50096	449.98	
36" x 108"	4"	3,680	IK36120-40108	585.44	IM36120-40108	414.67	IK36144-40108	641.87	IM36144-40108	442.88	
36" x 108"	5"	5,470	IK36120-50108	621.31	IM36120-50108	450.53	IK36144-50108	677.73	IM36144-50108	478.75	
36" x 120"	4"	3,020	IK36120-40120	610.34	IM36120-40120	439.57	IK36144-40120	666.77	IM36144-40120	467.79	
36" x 120"	5"	4,960	IK36120-50120	649.99	IM36120-50120	479.22	IK36144-50120	706.42	IM36144-50120	507.43	
36" x 144"	5"	3,610	IK36120-50144	707.36	IM36120-50144	536.59	IK36144-50144	763.79	IM36144-50144	564.81	
36" x 144"	6"	5,580	IK36120-60144	803.96	IM36120-60144	633.19	IK36144-60144	860.39	IM36144-60144	661.41	
42" x 96"	3.5"	3,420	IK42120-35096	549.80	IM42120-35096	375.91	IK42144-35096	607.03	IM42144-35096	404.52	
42" x 96"	4"	4,400	IK42120-40096	566.94	IM42120-40096	393.05	IK42144-40096	624.16	IM42144-40096	421.66	
42" x 96"	5"	6,100	IK42120-50096	598.77	IM42120-50096	424.88	IK42144-50096	656.00	IM42144-50096	453.50	
42" x 108"	4"	3,680	IK42120-40108	591.68	IM42120-40108	417.78	IK42144-40108	648.90	IM42144-40108	446.40	
42" x 108"	5"	5,470	IK42120-50108	627.54	IM42120-50108	453.65	IK42144-50108	684.77	IM42144-50108	482.27	
42" x 120"	4"	3,020	IK42120-40120	616.58	IM42120-40120	442.69	IK42144-40120	673.81	IM42144-40120	471.30	
42" x 120"	5"	4,960	IK42120-50120	656.23	IM42120-50120	482.34	IK42144-50120	713.45	IM42144-50120	510.95	
42" x 144"	5"	3,610	IK42120-50144	713.60	IM42120-50144	539.71	IK42144-50144	770.83	IM42144-50144	568.32	
42" x 144"	6"	5,580	IK42120-60144	810.20	IM42120-60144	636.31	IK42144-60144	867.43	IM42144-60144	664.92	
48" x 96"	3.5"	3,420	IK48120-35096	557.00	IM48120-35096	379.51	IK48144-35096	614.96	IM48144-35096	408.49	
48" x 96"	4"	4,400	IK48120-40096	574.14	IM48120-40096	396.65	IK48144-40096	632.10	IM48144-40096	425.63	
48" x 96"	5"	6,100	IK48120-50096	605.98	IM48120-50096	428.48	IK48144-50096	663.94	IM48144-50096	457.46	
48" x 108"	4"	3,680	IK48120-40108	598.88	IM48120-40108	421.39	IK48144-40108	656.84	IM48144-40108	450.37	
48" x 108"	5"	5,470	IK48120-50108	634.75	IM48120-50108	457.25	IK48144-50108	692.71	IM48144-50108	486.23	
48" x 120"	4"	3,020	IK48120-40120	623.78	IM48120-40120	446.29	IK48144-40120	681.74	IM48144-40120	475.27	
48" x 120"	5"	4,960	IK48120-50120	663.43	IM48120-50120	485.94	IK48144-50120	721.39	IM48144-50120	514.92	
48" x 144"	5"	3,610	IK48120-50144	720.80	IM48120-50144	543.31	IK48144-50144	778.76	IM48144-50144	572.29	
48" x 144"	6"	5,580	IK48120-60144	817.40	IM48120-60144	639.91	IK48144-60144	875.36	IM48144-60144	668.89	

Upright D x W	Beam Height	Cap. Per Pair	Starter Units		Add-On Units		Starter Units		Add-On Units		
			Model Number	Price Each	Model Number	Price Each	Model Number	Price Each	Model Number	Price Each	
Heavy Duty - 16' High						Heavy Duty - 20' High					
36" x 96"	3.5"	3,420	IK36192-35096	713.48	IM36192-35096	457.75	IK36240-35096	827.04	IM36240-35096	514.53	
36" x 96"	4"	4,400	IK36192-40096	730.61	IM36192-40096	474.88	IK36240-40096	844.18	IM36240-40096	531.67	
36" x 96"	5"	6,100	IK36192-50096	762.45	IM36192-50096	506.72	IK36240-50096	876.02	IM36240-50096	563.50	
36" x 108"	4"	3,680	IK36192-40108	755.35	IM36192-40108	499.62	IK36240-40108	868.92	IM36240-40108	556.41	
36" x 108"	5"	5,470	IK36192-50108	791.22	IM36192-50108	535.49	IK36240-50108	904.79	IM36240-50108	592.27	
36" x 120"	4"	3,020	IK36192-40120	780.26	IM36192-40120	524.53	IK36240-40120	893.82	IM36240-40120	581.31	
36" x 120"	5"	4,960	IK36192-50120	819.90	IM36192-50120	564.18	IK36240-50120	933.47	IM36240-50120	620.96	
36" x 144"	5"	3,610	IK36192-50144	877.28	IM36192-50144	621.55	IK36240-50144	990.84	IM36240-50144	678.33	
36" x 144"	6"	5,580	IK36192-60144	973.88	IM36192-60144	718.15	IK36240-60144	1,087.44	IM36240-60144	774.93	
42" x 96"	3.5"	3,420	IK42192-35096	716.52	IM42192-35096	459.27	IK42240-35096	829.33	IM42240-35096	515.68	
42" x 96"	4"	4,400	IK42192-40096	733.66	IM42192-40096	476.41	IK42240-40096	846.47	IM42240-40096	532.81	
42" x 96"	5"	6,100	IK42192-50096	765.49	IM42192-50096	508.24	IK42240-50096	878.30	IM42240-50096	564.65	
42" x 108"	4"	3,680	IK42192-40108	758.39	IM42192-40108	501.14	IK42240-40108	871.21	IM42240-40108	557.55	
42" x 108"	5"	5,470	IK42192-50108	794.26	IM42192-50108	537.01	IK42240-50108	907.07	IM42240-50108	593.42	
42" x 120"	4"	3,020	IK42192-40120	783.30	IM42192-40120	526.05	IK42240-40120	896.11	IM42240-40120	582.46	
42" x 120"	5"	4,960	IK42192-50120	822.95	IM42192-50120	565.70	IK42240-50120	935.76	IM42240-50120	622.10	
42" x 144"	5"	3,610	IK42192-50144	880.32	IM42192-50144	623.07	IK42240-50144	993.13	IM42240-50144	679.48	
42" x 144"	6"	5,580	IK42192-60144	976.92	IM42192-60144	719.67	IK42240-60144	1,089.73	IM42240-60144	776.08	
48" x 96"	3.5"	3,420	IK48192-35096	734.60	IM48192-35096	468.31	IK48240-35096	851.61	IM48240-35096	526.82	
48" x 96"	4"	4,400	IK48192-40096	751.74	IM48192-40096	485.45	IK48240-40096	868.75	IM48240-40096	543.95	
48" x 96"	5"	6,100	IK48192-50096	783.57	IM48192-50096	517.28	IK48240-50096	900.59	IM48240-50096	575.79	
48" x 108"	4"	3,680	IK48192-40108	776.48	IM48192-40108	510.18	IK48240-40108	893.49	IM48240-40108	568.72	
48" x 108"	5"	5,470	IK48192-50108	812.34	IM48192-50108	546.05	IK48240-50108	929.36	IM48240-50108	604.56	
48" x 120"	4"	3,020	IK48192-40120	801.38	IM48192-40120	535.09	IK48240-40120	918.39	IM48240-40120	593.60	
48" x 120"	5"	4,960	IK48192-50120	841.03	IM48192-50120	574.74	IK48240-50120	958.04	IM48240-50120	633.24	
48" x 144"	5"	3,610	IK48192-50144	898.40	IM48192-50144	632.11	IK48240-50144	1,015.41	IM48240-50144	690.62	
48" x 144"	6"	5,580	IK48192-60144	995.00	IM48192-60144	728.71	IK48240-60144	1,112.01	IM48240-60144	787.22	

FastRak™ Bulk Storage Shelving

Save time and money with this heavy-duty bulk storage shelving. Featuring a newly designed heavier duty upright that has the advantage of component replacement in case of damage. Uprights come pre-assembled for all starter and add-on units. Ideal for storing bulky and/or heavy items. Choose between 3/4" particle board decking, 3/4" white laminated board decking, or wire mesh for shelf surface.

You can design your own system by purchasing the components individually or order complete units (pages 20-25) with your choice of wire mesh, 3/4" particle board decking, or 3/4" white laminated board decking.



- **Tear Drop Design**
Allows for quick/easy set-up
- **Built-in Safety Clip**
Secures the beam to upright for added safety
- **Heavy Duty Upright**
Newly designed heavier duty upright

FastRak™ is unique because it does not require a shelf at the bottom of the unit.



- » **Uprights allow adjustment of shelf height every 1½"**
- » **7,000 lbs. capacity per upright (based upon 36" max. shelf spacing)**
- » **Knock down heavy duty upright design**

FastRak™ Uprights

Featuring a newly designed heavier duty upright with detachable deluxe foot plates sold separately. Design allows for easier shipment while still providing up to 7,000 lbs. capacity per upright. Units feature a teardrop design that provides quick/easy assembly, as well as the functionality of sharing a common upright between units. Beams are adjustable in 1½". Uprights can be ordered assembled or un-assembled. Upright color: Green.

D x H	Unassembled		Assembled	
	Model Number	Price Each	Model Number	Price Each
18" x 72"	CU18072	44.80	CU18072A	49.29
18" x 96"	CU18096	54.85	CU18096A	60.33
18" x 120"	CU18120	68.48	CU18120A	75.33
24" x 72"	CU24072	47.71	CU24072A	52.48
24" x 96"	CU24096	57.72	CU24096A	63.49
24" x 120"	CU24120	71.28	CU24120A	78.41
36" x 72"	CU36072	56.83	CU36072A	62.51
36" x 96"	CU36096	66.83	CU36096A	73.52
36" x 120"	CU36120	76.84	CU36120A	84.53
36" x 144"	CU36144	86.85	CU36144A	95.53
48" x 72"	CU48072	65.94	CU48072A	72.53
48" x 96"	CU48096	75.96	CU48096A	83.55
48" x 120"	CU48120	85.96	CU48120A	94.56
48" x 144"	CU48144	95.98	CU48144A	105.58

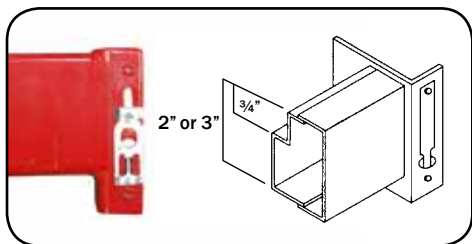

Step Load Beams

High capacity beams provide exceptional strength at a reasonable price. Built-in safety lock at end of beams helps prevent beams from accidentally getting knocked off uprights. Beam length is measured by clear span between uprights. Beams are designed specifically for use with wire mesh or 3/4" particle board decking. Beam color: Orange.

- » **Available in either 2" or 3" beam heights**
- » **Available in 24", 36", 48", 72" or 96" in length**
- » **Built-in safety clip for added safety**

H x L	Cap. Per Pair	Model Number	Price Each
2" x 48"	1,400	215-CB20048	14.87
2" x 72"	1,200	215-CB20072	21.38
2" x 96"	1,000	215-CB20096	27.90
3" x 24"	1,400	215-CBL30024	8.57
3" x 36"	1,200	215-CBL30036	12.39
3" x 48"	2,000	215-CB30048	18.31
3" x 72"	1,800	215-CB30072	26.54
3" x 96"	1,600	215-CB30096	34.80

Particle Board Decking

Heavy duty 3/4" particle board rests on the ledge of step beams and is flush with top of beam to provide smooth shelf surface. When ordering you must use steel supports in conjunction with particle board decking.



D x L	Model Number	Price Each
18" x 48"	240-044818	11.01
18" x 72"	240-047218	16.51
18" x 96"	240-049618	22.02
24" x 48"	240-044824	14.67
24" x 72"	240-047224	22.02
24" x 96"	240-049624	29.36
36" x 48"	240-044836	22.02
36" x 72"	240-047236	33.02
36" x 96"	240-049636	44.03
48" x 48"	240-044848	29.36
48" x 72"	240-047248	44.03
48" x 96"	240-049648	58.71

Laminated Board Decking

Heavy duty 3/4" laminated board rests on the ledge of step beams and is flush with top of beam to provide a smooth and durable shelf surface. White surface improves the appearance. When ordering you must use steel supports in conjunction with laminated board decking.



D x L	Model Number	Price Each
18" x 48"	240-094818	18.90
18" x 72"	240-097218	28.35
18" x 96"	240-099618	37.80
24" x 48"	240-094824	25.20
24" x 72"	240-097224	37.80
24" x 96"	240-099624	50.40
36" x 48"	240-094836	37.80
36" x 72"	240-097236	56.70
36" x 96"	240-099636	75.60
48" x 48"	240-094848	50.40
48" x 72"	240-097248	75.60
48" x 96"	240-099648	100.80



Shelf Supports

Used in conjunction with particle board to maximize shelf capacity. Shelf supports fit into notches in beams to maintain a level shelf surface. Support color: Orange

Length	Model Number	Price Each
24"	215-CSS24	3.23
36"	215-CSS36	4.84
48"	215-CSS48	6.38

Required Per Level

- 48" Beams - 2 Supports
- 72" Beams - 3 Supports
- 96" Beams - 4 Supports



Wire deck rests securely on top of beams. Integrated steel deck supports provide for high capacity.



Safety Supports not Required!

Wire Mesh Decking

Improves ventilation and reduces dust build-up. Designed specifically for the FastRak product, this wire mesh decking fits perfectly on top of beams. Waterfall design of wire mesh curves over top of beams to provide smooth shelf surface. Combine multiple decks for longer shelf widths. Color: Gray.

Deck D x W	Model Number	Price Each
18" x 35"	215-CW1835	25.16
18" x 47"	215-CW1847	27.07
24" x 35"	215-CW2435	27.32
24" x 47"	215-CW2447	29.58
36" x 35"	215-CW3635	31.71
36" x 47"	215-CW3647	34.62
48" x 35"	215-CW4835	35.53
48" x 47"	215-CW4847	39.89



Deluxe Foot Plates

Foot plates are an optional addition to FastRak uprights. Foot plates easily bolt into the upright and allow FastRak to be anchored into concrete for additional safety or permanent placement. Color: Green. Concrete wedge anchors are sold separately (not shown).

Deluxe Foot Plate		Concrete Wedge Anchor	
Model Number	Price Each	Model Number	Price Each
CUCF01	3.23	235-FA01	1.12



Label Holders

These durable label holders are extra large and ideal for FastRak or Pallet Rack applications. Self-Adhesive or Magnetic label holders are available and allows for simple label relocation. Side loading. Includes Inkjet/Laser compatible white inserts with instructions. Bar code compatible.

		Adhesive		Magnetic	
H x W	Qty.	Model Number	Price Each	Model Number	Price Each
3" x 5"	50	215-L335	66.94	215-L335M	92.25

FastRak™ Features 3/4" Particle Board Decking

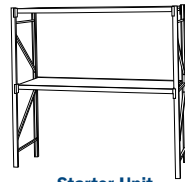

Starter Unit

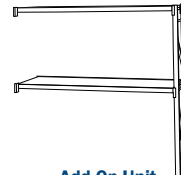

Add-On Unit

Uprights come pre-assembled, upright assembly included in price listed below



Size D x W	Beam H	Shelf Cap.	Model Number	Price Each	Model Number	Price Each	Model Number	Price Each
6' HIGH UNITS						Extra Shelf		
18" x 48"	2"	1,400	KS2-4818072W	171.11	KT2-4818072W	126.30	KX2-4818W	40.75
18" x 48"	3"	2,000	KS3-4818072W	184.88	KT3-4818072W	140.08	KX3-4818W	47.64
18" x 72"	2"	1,200	KS2-7218072W	208.13	KT2-7218072W	163.33	KX2-7218W	59.26
18" x 72"	3"	1,800	KS3-7218072W	228.80	KT3-7218072W	183.99	KX3-7218W	69.59
18" x 96"	2"	1,000	KS2-9618072W	245.24	KT2-9618072W	200.43	KX2-9618W	77.82
18" x 96"	3"	1,600	KS3-9618072W	272.83	KT3-9618072W	228.03	KX3-9618W	91.61
24" x 48"	2"	1,400	KS2-4824072W	190.70	KT2-4824072W	149.46	KX2-4824W	50.87
24" x 48"	3"	2,000	KS3-4824072W	210.95	KT3-4824072W	163.23	KX3-4824W	57.76
24" x 72"	2"	1,200	KS2-7224072W	244.38	KT2-7224072W	196.67	KX2-7224W	74.48
24" x 72"	3"	1,800	KS3-7224072W	265.04	KT3-7224072W	217.33	KX3-7224W	84.81
24" x 96"	2"	1,000	KS2-9624072W	291.61	KT2-9624072W	243.89	KX2-9624W	98.09
24" x 96"	3"	1,600	KS3-9624072W	319.20	KT3-9624072W	271.49	KX3-9624W	111.89
36" x 48"	2"	1,400	KS2-4836072W	236.52	KT2-4836072W	179.70	KX2-4836W	61.44
36" x 48"	3"	2,000	KS3-4836072W	250.30	KT3-4836072W	193.47	KX3-4836W	68.32
36" x 72"	2"	1,200	KS2-7236072W	294.25	KT2-7236072W	237.43	KX2-7236W	90.30
36" x 72"	3"	1,800	KS3-7236072W	314.92	KT3-7236072W	258.09	KX3-7236W	100.63
36" x 96"	2"	1,000	KS2-9636072W	352.02	KT2-9636072W	295.20	KX2-9636W	119.19
36" x 96"	3"	1,600	KS3-9636072W	379.62	KT3-9636072W	322.79	KX3-9636W	132.98
48" x 48"	2"	1,400	KS2-4848072W	275.60	KT2-4848072W	209.66	KX2-4848W	71.86
48" x 48"	3"	2,000	KS3-4848072W	289.38	KT3-4848072W	223.44	KX3-4848W	78.75
48" x 72"	2"	1,200	KS2-7248072W	343.75	KT2-7248072W	277.81	KX2-7248W	105.93
48" x 72"	3"	1,800	KS3-7248072W	364.41	KT3-7248072W	298.47	KX3-7248W	116.27
48" x 96"	2"	1,000	KS2-9648072W	411.96	KT2-9648072W	346.02	KX2-9648W	140.04
48" x 96"	3"	1,600	KS3-9648072W	439.55	KT3-9648072W	373.61	KX3-9648W	153.84
8' HIGH UNITS						Extra Shelf		
18" x 48"	2"	1,400	KS2-4818096W	191.21	KT2-4818096W	136.35	KX2-4818W	40.75
18" x 48"	3"	2,000	KS3-4818096W	204.98	KT3-4818096W	150.13	KX3-4818W	47.64
18" x 72"	2"	1,200	KS2-7218096W	228.23	KT2-7218096W	173.38	KX2-7218W	59.26
18" x 72"	3"	1,800	KS3-7218096W	248.89	KT3-7218096W	194.04	KX3-7218W	69.59
18" x 96"	2"	1,000	KS2-9618096W	265.34	KT2-9618096W	210.48	KX2-9618W	77.82
18" x 96"	3"	1,600	KS3-9618096W	292.93	KT3-9618096W	238.08	KX3-9618W	91.61
24" x 48"	2"	1,400	KS2-4824096W	217.18	KT2-4824096W	159.46	KX2-4824W	50.87
24" x 48"	3"	2,000	KS3-4824096W	230.96	KT3-4824096W	173.24	KX3-4824W	57.76
24" x 72"	2"	1,200	KS2-7224096W	264.39	KT2-7224096W	206.67	KX2-7224W	74.48
24" x 72"	3"	1,800	KS3-7224096W	285.05	KT3-7224096W	227.34	KX3-7224W	84.81
24" x 96"	2"	1,000	KS2-9624096W	311.62	KT2-9624096W	253.90	KX2-9624W	98.09
24" x 96"	3"	1,600	KS3-9624096W	339.21	KT3-9624096W	281.49	KX3-9624W	111.89
36" x 48"	2"	1,400	KS2-4836096W	256.54	KT2-4836096W	189.70	KX2-4836W	61.44
36" x 48"	3"	2,000	KS3-4836096W	270.31	KT3-4836096W	203.48	KX3-4836W	68.32
36" x 72"	2"	1,200	KS2-7236096W	314.27	KT2-7236096W	247.43	KX2-7236W	90.30
36" x 72"	3"	1,800	KS3-7236096W	334.93	KT3-7236096W	268.10	KX3-7236W	100.63
36" x 96"	2"	1,000	KS2-9636096W	372.04	KT2-9636096W	305.20	KX2-9636W	119.19
36" x 96"	3"	1,600	KS3-9636096W	399.63	KT3-9636096W	332.80	KX3-9636W	132.98
48" x 48"	2"	1,400	KS2-4848096W	295.64	KT2-4848096W	219.68	KX2-4848W	71.86
48" x 48"	3"	2,000	KS3-4848096W	309.41	KT3-4848096W	233.46	KX3-4848W	78.75
48" x 72"	2"	1,200	KS2-7248096W	363.78	KT2-7248096W	287.83	KX2-7248W	105.93
48" x 72"	3"	1,800	KS3-7248096W	384.45	KT3-7248096W	308.49	KX3-7248W	116.27
48" x 96"	2"	1,000	KS2-9648096W	431.99	KT2-9648096W	356.03	KX2-9648W	140.04
48" x 96"	3"	1,600	KS3-9648096W	459.59	KT3-9648096W	383.63	KX3-9648W	153.84

These complete units are priced to include industrial strength 3/4" particle board decking that provides a smooth and durable shelf surface that sits flush with the top of beams allowing for easy loading and unloading of stored material. Priced as 2 shelf units that can be set-up so that goods can be stored on floor. Choose between 6', 8', 10' or 12' tall units. Extra shelf pricing to right of the tables. Uprights are shipped pre-assembled.



Uprights come pre-assembled, upright assembly included in price listed below

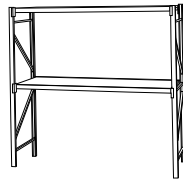

Starter Unit

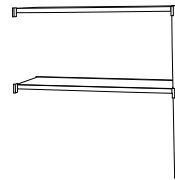

Add-On Unit

Model Number Code: KS2-4818072W

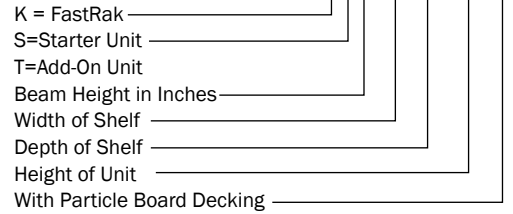

Size D x W	Beam H	Shelf Cap.	Model Number	Price Each	Model Number	Price Each	Model Number	Price Each
10' HIGH UNITS								
						Extra Shelf		
18" x 48"	2"	1,400	KS2-4818120W	218.46	KT2-4818120W	149.98	KX2-4818W	40.75
18" x 48"	3"	2,000	KS3-4818120W	232.24	KT3-4818120W	163.76	KX3-4818W	47.64
18" x 72"	2"	1,200	KS2-7218120W	255.49	KT2-7218120W	187.01	KX2-7218W	59.26
18" x 72"	3"	1,800	KS3-7218120W	276.15	KT3-7218120W	207.67	KX3-7218W	69.59
18" x 96"	2"	1,000	KS2-9618120W	292.59	KT2-9618120W	224.11	KX2-9618W	77.82
18" x 96"	3"	1,600	KS3-9618120W	320.19	KT3-9618120W	251.71	KX3-9618W	91.61
24" x 48"	2"	1,400	KS2-4824120W	244.31	KT2-4824120W	173.03	KX2-4824W	50.87
24" x 48"	3"	2,000	KS3-4824120W	258.09	KT3-4824120W	186.81	KX3-4824W	57.76
24" x 72"	2"	1,200	KS2-7224120W	291.52	KT2-7224120W	220.24	KX2-7224W	74.48
24" x 72"	3"	1,800	KS3-7224120W	312.19	KT3-7224120W	240.90	KX3-7224W	84.81
24" x 96"	2"	1,000	KS2-9624120W	338.75	KT2-9624120W	267.47	KX2-9624W	98.09
24" x 96"	3"	1,600	KS3-9624120W	366.35	KT3-9624120W	295.06	KX3-9624W	111.89
36" x 48"	2"	1,400	KS2-4836120W	290.33	KT2-4836120W	199.71	KX2-4836W	61.44
36" x 48"	3"	2,000	KS3-4836120W	276.55	KT3-4836120W	213.49	KX3-4836W	68.32
36" x 72"	2"	1,200	KS2-7236120W	334.28	KT2-7236120W	257.44	KX2-7236W	90.30
36" x 72"	3"	1,800	KS3-7236120W	364.62	KT3-7236120W	287.78	KX3-7236W	100.63
36" x 96"	2"	1,000	KS2-9636120W	392.05	KT2-9636120W	315.21	KX2-9636W	119.19
36" x 96"	3"	1,600	KS3-9636120W	419.64	KT3-9636120W	342.80	KX3-9636W	132.98
48" x 48"	2"	1,400	KS2-4848120W	315.65	KT2-4848120W	229.69	KX2-4848W	71.86
48" x 48"	3"	2,000	KS3-4848120W	329.43	KT3-4848120W	243.46	KX3-4848W	78.75
48" x 72"	2"	1,200	KS2-7248120W	383.80	KT2-7248120W	297.83	KX2-7248W	105.93
48" x 72"	3"	1,800	KS3-7248120W	404.46	KT3-7248120W	318.50	KX3-7248W	116.27
48" x 96"	2"	1,000	KS2-9648120W	452.00	KT2-9648120W	366.04	KX2-9648W	140.04
48" x 96"	3"	1,600	KS3-9648120W	479.60	KT3-9648120W	393.63	KX3-9648W	153.84
12' HIGH UNITS								
						Extra Shelf		
36" x 48"	2"	1,400	KS2-4836144W	296.56	KT2-4836144W	209.72	KX2-4836W	61.44
36" x 48"	3"	2,000	KS3-4836144W	310.34	KT3-4836144W	223.49	KX3-4836W	68.32
36" x 72"	2"	1,200	KS2-7236144W	354.29	KT2-7236144W	267.45	KX2-7236W	90.30
36" x 72"	3"	1,800	KS3-7236144W	374.96	KT3-7236144W	288.11	KX3-7236W	100.63
36" x 96"	2"	1,000	KS2-9636144W	412.06	KT2-9636144W	325.22	KX2-9636W	119.19
36" x 96"	3"	1,600	KS3-9636144W	439.66	KT3-9636144W	352.81	KX3-9636W	132.98
48" x 48"	2"	1,400	KS2-4848144W	335.69	KT2-4848144W	239.70	KX2-4848W	71.86
48" x 48"	3"	2,000	KS3-4848144W	349.46	KT3-4848144W	253.48	KX3-4848W	78.75
48" x 72"	2"	1,200	KS2-7248144W	403.83	KT2-7248144W	307.85	KX2-7248W	105.93
48" x 72"	3"	1,800	KS3-7248144W	424.49	KT3-7248144W	328.51	KX3-7248W	116.27
48" x 96"	2"	1,000	KS2-9648144W	472.04	KT2-9648144W	376.06	KX2-9648W	140.04
48" x 96"	3"	1,600	KS3-9648144W	499.63	KT3-9648144W	403.65	KX3-9648W	153.84

FastRak™ Features 3/4" Laminated Board Decking

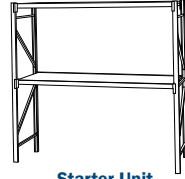

Starter Unit

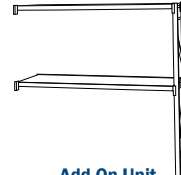

Add-On Unit

Uprights come pre-assembled, upright assembly included in price listed below

Size D x W	BeaL H	Shelf Cap.	Lodel NuLber	Price Each	Lodel NuLber	Price Each	Lodel NuLber	Price Each
6' HIGH UNITS							Extra Shelf	
18" x 48"	2"	1,400	KS2-4818072L	195.85	KT2-4818072L	146.56	KX2-4818L	48.64
18" x 48"	3"	2,000	KS3-4818072L	209.62	KT3-4818072L	160.34	KX3-4818L	55.52
18" x 72"	2"	1,200	KS2-7218072L	240.79	KT2-7218072L	191.50	KX2-7218L	71.11
18" x 72"	3"	1,800	KS3-7218072L	261.45	KT3-7218072L	212.16	KX3-7218L	81.44
18" x 96"	2"	1,000	KS2-9618072L	285.77	KT2-9618072L	236.48	KX2-9618L	93.60
18" x 96"	3"	1,600	KS3-9618072L	313.36	KT3-9618072L	264.08	KX3-9618L	107.39
24" x 48"	2"	1,400	KS2-4824072L	227.77	KT2-4824072L	175.29	KX2-4824L	61.40
24" x 48"	3"	2,000	KS3-4824072L	241.54	KT3-4824072L	189.06	KX3-4824L	68.29
24" x 72"	2"	1,200	KS2-7224072L	285.47	KT2-7224072L	233.00	KX2-7224L	90.26
24" x 72"	3"	1,800	KS3-7224072L	306.14	KT3-7224072L	253.66	KX3-7224L	100.59
24" x 96"	2"	1,000	KS2-9624072L	343.22	KT2-9624072L	290.75	KX2-9624L	119.13
24" x 96"	3"	1,600	KS3-9624072L	370.82	KT3-9624072L	318.34	KX3-9624L	132.93
36" x 48"	2"	1,400	KS2-4836072L	279.45	KT2-4836072L	216.94	KX2-4836L	77.22
36" x 48"	3"	2,000	KS3-4836072L	293.22	KT3-4836072L	230.72	KX3-4836L	84.11
36" x 72"	2"	1,200	KS2-7236072L	352.97	KT2-7236072L	290.46	KX2-7236L	113.98
36" x 72"	3"	1,800	KS3-7236072L	373.63	KT3-7236072L	311.13	KX3-7236L	124.31
36" x 96"	2"	1,000	KS2-9636072L	426.53	KT2-9636072L	364.02	KX2-9636L	150.76
36" x 96"	3"	1,600	KS3-9636072L	454.13	KT3-9636072L	391.62	KX3-9636L	164.56
48" x 48"	2"	1,400	KS2-4848072L	330.88	KT2-4848072L	258.34	KX2-4848L	92.90
48" x 48"	3"	2,000	KS3-4848072L	344.65	KT3-4848072L	272.12	KX3-4848L	99.79
48" x 72"	2"	1,200	KS2-7248072L	420.08	KT2-7248072L	347.55	KX2-7248L	137.51
48" x 72"	3"	1,800	KS3-7248072L	440.75	KT3-7248072L	368.21	KX3-7248L	147.84
48" x 96"	2"	1,000	KS2-9648072L	509.33	KT2-9648072L	436.80	KX2-9648L	182.13
48" x 96"	3"	1,600	KS3-9648072L	536.93	KT3-9648072L	464.39	KX3-9648L	195.93
8' HIGH UNITS							Extra Shelf	
18" x 48"	2"	1,400	KS2-4818096L	217.94	KT2-4818096L	157.61	KX2-4818L	48.64
18" x 48"	3"	2,000	KS3-4818096L	231.71	KT3-4818096L	171.38	KX3-4818L	55.52
18" x 72"	2"	1,200	KS2-7218096L	262.88	KT2-7218096L	202.55	KX2-7218L	71.11
18" x 72"	3"	1,800	KS3-7218096L	283.54	KT3-7218096L	223.21	KX3-7218L	81.44
18" x 96"	2"	1,000	KS2-9618096L	307.86	KT2-9618096L	247.53	KX2-9618L	93.60
18" x 96"	3"	1,600	KS3-9618096L	335.45	KT3-9618096L	275.12	KX3-9618L	107.39
24" x 48"	2"	1,400	KS2-4824096L	249.80	KT2-4824096L	186.30	KX2-4824L	61.40
24" x 48"	3"	2,000	KS3-4824096L	263.57	KT3-4824096L	200.08	KX3-4824L	68.29
24" x 72"	2"	1,200	KS2-7224096L	307.50	KT2-7224096L	244.01	KX2-7224L	90.26
24" x 72"	3"	1,800	KS3-7224096L	328.17	KT3-7224096L	264.67	KX3-7224L	100.59
24" x 96"	2"	1,000	KS2-9624096L	365.25	KT2-9624096L	301.76	KX2-9624L	119.13
24" x 96"	3"	1,600	KS3-9624096L	392.85	KT3-9624096L	329.35	KX3-9624L	132.93
36" x 48"	2"	1,400	KS2-4836096L	301.48	KT2-4836096L	227.96	KX2-4836L	77.22
36" x 48"	3"	2,000	KS3-4836096L	315.25	KT3-4836096L	241.73	KX3-4836L	84.11
36" x 72"	2"	1,200	KS2-7236096L	375.00	KT2-7236096L	301.48	KX2-7236L	113.98
36" x 72"	3"	1,800	KS3-7236096L	395.66	KT3-7236096L	322.14	KX3-7236L	124.31
36" x 96"	2"	1,000	KS2-9636096L	448.56	KT2-9636096L	375.04	KX2-9636L	150.76
36" x 96"	3"	1,600	KS3-9636096L	476.15	KT3-9636096L	402.63	KX3-9636L	164.56
48" x 48"	2"	1,400	KS2-4848096L	352.91	KT2-4848096L	269.36	KX2-4848L	92.90
48" x 48"	3"	2,000	KS3-4848096L	366.68	KT3-4848096L	283.13	KX3-4848L	99.79
48" x 72"	2"	1,200	KS2-7248096L	442.11	KT2-7248096L	358.56	KX2-7248L	137.51
48" x 72"	3"	1,800	KS3-7248096L	462.78	KT3-7248096L	379.23	KX3-7248L	147.84
48" x 96"	2"	1,000	KS2-9648096L	531.36	KT2-9648096L	447.81	KX2-9648L	182.13
48" x 96"	3"	1,600	KS3-9648096L	558.96	KT3-9648096L	475.41	KX3-9648L	195.93

These complete units are priced to include high capacity 3/4" laminated board decking. Priced as 2 shelf units that can be set-up so that goods can be stored on floor. Choose between 6', 8', 10' or 12' tall units. Extra shelf pricing to right of the tables. Uprights are shipped pre-assembled.



Uprights come pre-assembled, upright assembly included in price listed below

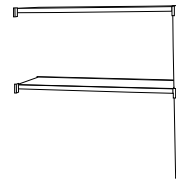
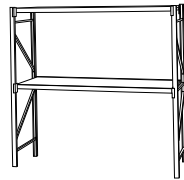

Model Number Code: KS2-4818072L

K = FastRak
 S=Starter Unit
 T=Add-On Unit
 Beam Height in Inches
 Width of Shelf
 Depth of Shelf
 Height of Unit
 With Laminated Decking

Size D x W	Beam H	Shelf Cap.	Model NuLber	Price Each	Model NuLber	Price Each	Model NuLber	Price Each
10' HIGH UNITS								
			Extra Shelf					
18" x 48"	2"	1,400	KS2-4818120L	247.93	KT2-4818120L	172.60	KX2-4818L	48.64
18" x 48"	3"	2,000	KS3-4818120L	261.70	KT3-4818120L	186.38	KX3-4818L	55.52
18" x 72"	2"	1,200	KS2-7218120L	292.87	KT2-7218120L	217.54	KX2-7218L	71.11
18" x 72"	3"	1,800	KS3-7218120L	313.53	KT3-7218120L	238.20	KX3-7218L	81.44
18" x 96"	2"	1,000	KS2-9618120L	337.85	KT2-9618120L	262.52	KX2-9618L	93.60
18" x 96"	3"	1,600	KS3-9618120L	365.44	KT3-9618120L	290.12	KX3-9618L	107.39
24" x 48"	2"	1,400	KS2-4824120L	279.64	KT2-4824120L	201.22	KX2-4824L	61.40
24" x 48"	3"	2,000	KS3-4824120L	293.41	KT3-4824120L	215.00	KX3-4824L	68.29
24" x 72"	2"	1,200	KS2-7224120L	337.34	KT2-7224120L	258.93	KX2-7224L	90.26
24" x 72"	3"	1,800	KS3-7224120L	358.01	KT3-7224120L	279.59	KX3-7224L	100.59
24" x 96"	2"	1,000	KS2-9624120L	395.09	KT2-9624120L	316.68	KX2-9624L	119.13
24" x 96"	3"	1,600	KS3-9624120L	422.69	KT3-9624120L	344.27	KX3-9624L	132.93
36" x 48"	2"	1,400	KS2-4836120L	323.48	KT2-4836120L	238.96	KX2-4836L	77.22
36" x 48"	3"	2,000	KS3-4836120L	337.26	KT3-4836120L	252.74	KX3-4836L	84.11
36" x 72"	2"	1,200	KS2-7236120L	397.01	KT2-7236120L	312.48	KX2-7236L	113.98
36" x 72"	3"	1,800	KS3-7236120L	417.67	KT3-7236120L	333.14	KX3-7236L	124.31
36" x 96"	2"	1,000	KS2-9636120L	470.57	KT2-9636120L	386.04	KX2-9636L	150.76
36" x 96"	3"	1,600	KS3-9636120L	498.16	KT3-9636120L	413.64	KX3-9636L	164.56
48" x 48"	2"	1,400	KS2-4848120L	374.93	KT2-4848120L	280.37	KX2-4848L	92.90
48" x 48"	3"	2,000	KS3-4848120L	388.71	KT3-4848120L	294.15	KX3-4848L	99.79
48" x 72"	2"	1,200	KS2-7248120L	464.14	KT2-7248120L	369.58	KX2-7248L	137.51
48" x 72"	3"	1,800	KS3-7248120L	484.81	KT3-7248120L	390.24	KX3-7248L	147.84
48" x 96"	2"	1,000	KS2-9648120L	553.39	KT2-9648120L	458.83	KX2-9648L	182.13
48" x 96"	3"	1,600	KS3-9648120L	580.99	KT3-9648120L	486.42	KX3-9648L	195.93
12' HIGH UNITS								
			Extra Shelf					
36" x 48"	2"	1,400	KS2-4836144L	345.49	KT2-4836144L	249.96	KX2-4836L	77.22
36" x 48"	3"	2,000	KS3-4836144L	359.27	KT3-4836144L	263.74	KX3-4836L	84.11
36" x 72"	2"	1,200	KS2-7236144L	419.01	KT2-7236144L	323.48	KX2-7236L	113.98
36" x 72"	3"	1,800	KS3-7236144L	439.68	KT3-7236144L	344.15	KX3-7236L	124.31
36" x 96"	2"	1,000	KS2-9636144L	492.58	KT2-9636144L	397.05	KX2-9636L	150.76
36" x 96"	3"	1,600	KS3-9636144L	520.17	KT3-9636144L	424.64	KX3-9636L	164.56
48" x 48"	2"	1,400	KS2-4848144L	396.96	KT2-4848144L	291.39	KX2-4848L	92.90
48" x 48"	3"	2,000	KS3-4848144L	410.74	KT3-4848144L	305.16	KX3-4848L	99.79
48" x 72"	2"	1,200	KS2-7248144L	486.17	KT2-7248144L	380.59	KX2-7248L	137.51
48" x 72"	3"	1,800	KS3-7248144L	506.84	KT3-7248144L	401.26	KX3-7248L	147.84
48" x 96"	2"	1,000	KS2-9648144L	575.42	KT2-9648144L	469.84	KX2-9648L	182.13
48" x 96"	3"	1,600	KS3-9648144L	603.02	KT3-9648144L	497.44	KX3-9648L	195.93

FastRak™ Features Wire Mesh Decking



Starter Unit



Add-On Unit

Uprights come pre-assembled, upright assembly included in price listed below



Size D x W	Beam H	Shelf Cap.	Model Number	Price Each	Model Number	Price Each	Model Number	Price Each
6' HIGH UNITS						Extra Shelf		
18" x 48"	2"	1,400	KS2-4818072M	203.22	KT2-4818072M	158.41	KX2-4818M	56.81
18" x 48"	3"	2,000	KS3-4818072M	216.99	KT3-4818072M	172.19	KX3-4818M	63.69
18" x 72"	2"	1,200	KS2-7218072M	275.75	KT2-7218072M	230.95	KX2-7218M	93.07
18" x 72"	3"	1,800	KS3-7218072M	296.42	KT3-7218072M	251.61	KX3-7218M	103.40
18" x 96"	2"	1,000	KS2-9618072M	309.48	KT2-9618072M	264.67	KX2-9618M	109.94
18" x 96"	3"	1,600	KS3-9618072M	337.07	KT3-9618072M	292.27	KX3-9618M	123.73
24" x 48"	2"	1,400	KS2-4824072M	214.05	KT2-4824072M	166.34	KX2-4824M	59.31
24" x 48"	3"	2,000	KS3-4824072M	227.83	KT3-4824072M	180.12	KX3-4824M	66.20
24" x 72"	2"	1,200	KS2-7224072M	290.22	KT2-7224072M	242.51	KX2-7224M	97.40
24" x 72"	3"	1,800	KS3-7224072M	310.88	KT3-7224072M	263.17	KX3-7224M	107.73
24" x 96"	2"	1,000	KS2-9624072M	325.33	KT2-9624072M	277.62	KX2-9624M	114.95
24" x 96"	3"	1,600	KS3-9624072M	352.93	KT3-9624072M	305.21	KX3-9624M	128.75
36" x 48"	2"	1,400	KS2-4836072M	242.36	KT2-4836072M	185.54	KX2-4836M	64.35
36" x 48"	3"	2,000	KS3-4836072M	256.14	KT3-4836072M	199.31	KX3-4836M	71.24
36" x 72"	2"	1,200	KS2-7236072M	326.00	KT2-7236072M	269.18	KX2-7236M	106.18
36" x 72"	3"	1,800	KS3-7236072M	346.67	KT3-7236072M	289.84	KX3-7236M	116.51
36" x 96"	2"	1,000	KS2-9636072M	363.72	KT2-9636072M	306.89	KX2-9636M	125.03
36" x 96"	3"	1,600	KS3-9636072M	391.31	KT3-9636072M	334.49	KX3-9636M	138.83
48" x 48"	2"	1,400	KS2-4848072M	271.13	KT2-4848072M	205.19	KX2-4848M	69.63
48" x 48"	3"	2,000	KS3-4848072M	284.91	KT3-4848072M	218.97	KX3-4848M	76.51
48" x 72"	2"	1,200	KS2-7248072M	359.52	KT2-7248072M	293.58	KX2-7248M	113.82
48" x 72"	3"	1,800	KS3-7248072M	380.18	KT3-7248072M	314.24	KX3-7248M	124.15
48" x 96"	2"	1,000	KS2-9648072M	403.03	KT2-9648072M	337.09	KX2-9648M	135.58
48" x 96"	3"	1,600	KS3-9648072M	430.63	KT3-9648072M	364.69	KX3-9648M	149.37
8' HIGH UNITS						Extra Shelf		
18" x 48"	2"	1,400	KS2-4818096M	223.31	KT2-4818096M	168.46	KX2-4818M	56.81
18" x 48"	3"	2,000	KS3-4818096M	237.09	KT3-4818096M	182.24	KX3-4818M	63.69
18" x 72"	2"	1,200	KS2-7218096M	295.85	KT2-7218096M	241.00	KX2-7218M	93.07
18" x 72"	3"	1,800	KS3-7218096M	316.51	KT3-7218096M	261.66	KX3-7218M	103.40
18" x 96"	2"	1,000	KS2-9618096M	329.57	KT2-9618096M	274.72	KX2-9618M	109.94
18" x 96"	3"	1,600	KS3-9618096M	357.17	KT3-9618096M	302.32	KX3-9618M	123.73
24" x 48"	2"	1,400	KS2-4824096M	234.07	KT2-4824096M	176.35	KX2-4824M	59.31
24" x 48"	3"	2,000	KS3-4824096M	247.84	KT3-4824096M	190.12	KX3-4824M	66.20
24" x 72"	2"	1,200	KS2-7224096M	310.23	KT2-7224096M	252.51	KX2-7224M	97.40
24" x 72"	3"	1,800	KS3-7224096M	330.90	KT3-7224096M	273.18	KX3-7224M	107.73
24" x 96"	2"	1,000	KS2-9624096M	345.35	KT2-9624096M	287.63	KX2-9624M	114.95
24" x 96"	3"	1,600	KS3-9624096M	372.94	KT3-9624096M	315.22	KX3-9624M	128.75
36" x 48"	2"	1,400	KS2-4836096M	262.37	KT2-4836096M	195.54	KX2-4836M	64.35
36" x 48"	3"	2,000	KS3-4836096M	276.15	KT3-4836096M	209.32	KX3-4836M	71.24
36" x 72"	2"	1,200	KS2-7236096M	346.02	KT2-7236096M	279.18	KX2-7236M	106.18
36" x 72"	3"	1,800	KS3-7236096M	366.68	KT3-7236096M	299.85	KX3-7236M	116.51
36" x 96"	2"	1,000	KS2-9636096M	383.73	KT2-9636096M	316.90	KX2-9636M	125.03
36" x 96"	3"	1,600	KS3-9636096M	411.33	KT3-9636096M	344.49	KX3-9636M	138.83
48" x 48"	2"	1,400	KS2-4848096M	291.17	KT2-4848096M	215.21	KX2-4848M	69.63
48" x 48"	3"	2,000	KS3-4848096M	304.94	KT3-4848096M	228.98	KX3-4848M	76.51
48" x 72"	2"	1,200	KS2-7248096M	379.55	KT2-7248096M	303.60	KX2-7248M	113.82
48" x 72"	3"	1,800	KS3-7248096M	400.22	KT3-7248096M	324.26	KX3-7248M	124.15
48" x 96"	2"	1,000	KS2-9648096M	423.07	KT2-9648096M	347.11	KX2-9648M	135.58
48" x 96"	3"	1,600	KS3-9648096M	450.66	KT3-9648096M	374.70	KX3-9648M	149.37

These complete units are priced to include high capacity wire mesh decking that features a waterfall design so that wire mesh curves over top of beams to provide a smooth shelf surface. Priced as 2 shelf units that can be set-up so that goods can be stored on floor. Choose between 6', 8', 10' or 12' tall units. Extra shelf pricing to right of the tables. Uprights are shipped pre-assembled.



**Uprights come
pre-assembled, upright
assembly included in
price listed below**

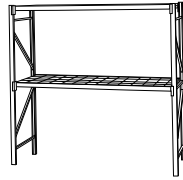

Starter Unit

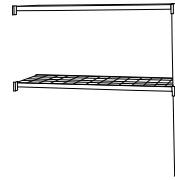

Add-On Unit



Model Number Code: KS2-4818072M

K = FastRak
S = Starter Unit
T = Add-On Unit
Beam Height in Inches
Width of Shelf
Depth of Shelf
Height of Unit
With Wire Mesh Decking

Size D x W	Beam H	Shelf Cap.	Model Number	Price Each	Model Number	Price Each	Model Number	Price Each
10' HIGH UNITS								
18" x 48"	2"	1,400	KS2-4818120M	250.57	KT2-4818120M	182.09	KX2-4818M	56.81
18" x 48"	3"	2,000	KS3-4818120M	264.35	KT3-4818120M	195.87	KX3-4818M	63.69
18" x 72"	2"	1,200	KS2-7218120M	323.11	KT2-7218120M	254.63	KX2-7218M	93.07
18" x 72"	3"	1,800	KS3-7218120M	343.77	KT3-7218120M	275.29	KX3-7218M	103.40
18" x 96"	2"	1,000	KS2-9618120M	356.83	KT2-9618120M	288.35	KX2-9618M	109.94
18" x 96"	3"	1,600	KS3-9618120M	384.43	KT3-9618120M	315.95	KX3-9618M	123.73
24" x 48"	2"	1,400	KS2-4824120M	281.82	KT2-4824120M	189.91	KX2-4824M	59.31
24" x 48"	3"	2,000	KS3-4824120M	274.97	KT3-4824120M	203.69	KX3-4824M	66.20
24" x 72"	2"	1,200	KS2-7224120M	337.37	KT2-7224120M	266.08	KX2-7224M	97.40
24" x 72"	3"	1,800	KS3-7224120M	358.03	KT3-7224120M	286.74	KX3-7224M	107.73
24" x 96"	2"	1,000	KS2-9624120M	372.48	KT2-9624120M	301.19	KX2-9624M	114.95
24" x 96"	3"	1,600	KS3-9624120M	400.07	KT3-9624120M	328.79	KX3-9624M	128.75
36" x 48"	2"	1,400	KS2-4836120M	282.39	KT2-4836120M	205.55	KX2-4836M	64.35
36" x 48"	3"	2,000	KS3-4836120M	296.16	KT3-4836120M	219.32	KX3-4836M	71.24
36" x 72"	2"	1,200	KS2-7236120M	366.03	KT2-7236120M	289.19	KX2-7236M	106.18
36" x 72"	3"	1,800	KS3-7236120M	386.69	KT3-7236120M	309.86	KX3-7236M	116.51
36" x 96"	2"	1,000	KS2-9636120M	403.75	KT2-9636120M	326.91	KX2-9636M	125.03
36" x 96"	3"	1,600	KS3-9636120M	431.34	KT3-9636120M	354.50	KX3-9636M	138.83
48" x 48"	2"	1,400	KS2-4848120M	311.18	KT2-4848120M	225.21	KX2-4848M	69.63
48" x 48"	3"	2,000	KS3-4848120M	324.95	KT3-4848120M	238.99	KX3-4848M	76.51
48" x 72"	2"	1,200	KS2-7248120M	399.57	KT2-7248120M	313.60	KX2-7248M	113.82
48" x 72"	3"	1,800	KS3-7248120M	420.23	KT3-7248120M	334.27	KX3-7248M	124.15
48" x 96"	2"	1,000	KS2-9648120M	443.08	KT2-9648120M	357.12	KX2-9648M	135.58
48" x 96"	3"	1,600	KS3-9648120M	470.67	KT3-9648120M	384.71	KX3-9648M	149.37
12' HIGH UNITS								
36" x 48"	2"	1,400	KS2-4836144M	302.40	KT2-4836144M	226.10	KX2-4836M	64.35
36" x 48"	3"	2,000	KS3-4836144M	316.18	KT3-4836144M	239.87	KX3-4836M	71.24
36" x 72"	2"	1,200	KS2-7236144M	386.04	KT2-7236144M	299.20	KX2-7236M	106.18
36" x 72"	3"	1,800	KS3-7236144M	406.71	KT3-7236144M	319.86	KX3-7236M	116.51
36" x 96"	2"	1,000	KS2-9636144M	423.76	KT2-9636144M	406.15	KX2-9636M	125.03
36" x 96"	3"	1,600	KS3-9636144M	451.35	KT3-9636144M	433.74	KX3-9636M	138.83
48" x 48"	2"	1,400	KS2-4848144M	331.21	KT2-4848144M	235.23	KX2-4848M	69.63
48" x 48"	3"	2,000	KS3-4848144M	344.99	KT3-4848144M	249.01	KX3-4848M	76.51
48" x 72"	2"	1,200	KS2-7248144M	419.60	KT2-7248144M	323.62	KX2-7248M	113.82
48" x 72"	3"	1,800	KS3-7248144M	440.27	KT3-7248144M	344.28	KX3-7248M	124.15
48" x 96"	2"	1,000	KS2-9648144M	463.11	KT2-9648144M	367.13	KX2-9648M	135.58
48" x 96"	3"	1,600	KS3-9648144M	570.49	KT3-9648144M	474.51	KX3-9648M	149.37

FastRak™ Archive Storage Units Features 3/4" Particle Board Decking

Made from the industrial strength FastRak™, these archive storage racks are built to hold even your heaviest archive boxes. Featuring heavy-duty uprights with a bolt together design that has the advantage of component replacement in case of damage. Each level will hold 1,600 lbs. Units are designed to accommodate either 15" deep or 24" deep archive boxes and are priced with or without boxes. Single depth and double box depth configurations are also available. Units priced below include assembled uprights.



Archive File Boxes

225-SF1



225-SF2



225-SF1 - 15" Deep Archive Boxes - \$4.75 ea.

These rugged 200 lbs. corrugated boxes are ideal for storing documents. Boxes can accommodate either letter size or legal size records. Sold 12 per bundle. Priced per box.

225-SF2 - 24" Deep Archive Boxes - \$7.12 ea.

Double walled panels and reinforced handles provide added strength and durability. Tight fitting lid adds rigidity and can be removed for easy access to records. Sold 12 per bundle. Priced per box

Size: 24"D x 12"W x 11"H Color: White

Size W x D x H	# of Levels	Box Cap.	Starter Units w/o Boxes		Starter Units with Boxes		Add-On Units w/o Boxes		Add-On Units with Boxes	
			Model Number	Price Each	Model Number	Price Each	Model Number	Price Each	Model Number	Price Each
Single Box Depth - 15" Deep Boxes										
48" x 18" x 96"	4	24	K34S-4818096W	300.26	K34S-4818096WS	419.96	K34T-4818096W	245.41	K34T-4818096WS	365.11
72" x 18" x 96"	4	40	K34S-7218096W	388.08	K34S-7218096WS	587.58	K34T-7218096W	333.23	K34T-7218096WS	532.73
96" x 18" x 96"	4	56	K34S-9618096W	476.15	K34S-9618096WS	755.45	K34T-9618096W	421.30	K34T-9618096WS	700.60
48" x 18" x 120"	5	30	K35S-4818120W	375.15	K35S-4818120WS	524.78	K35T-4818120W	306.67	K35T-4818120WS	456.30
72" x 18" x 120"	5	50	K35S-7218120W	484.93	K35S-7218120WS	734.31	K35T-7218120W	416.45	K35T-7218120WS	665.83
96" x 18" x 120"	5	70	K35S-9618120W	595.02	K35S-9618120WS	944.15	K35T-9618120W	526.54	K35T-9618120WS	875.67
Double Box Depth - 15" Deep Boxes										
48" x 36" x 96"	4	48	K34S-4836096W	406.96	K34S-4836096WS	646.36	K34T-4836096W	340.13	K34T-4836096WS	579.53
72" x 36" x 96"	4	80	K34S-7236096W	536.19	K34S-7236096WS	935.19	K34T-7236096W	469.36	K34T-7236096WS	868.36
96" x 36" x 96"	4	112	K34S-9636096W	665.60	K34S-9636096WS	1,224.20	K34T-9636096W	598.76	K34T-9636096WS	1,157.36
48" x 36" x 120"	5	60	K35S-4836120W	495.30	K35S-4836120WS	794.55	K35T-4836120W	418.46	K35T-4836120WS	717.71
72" x 36" x 120"	5	100	K35S-7236120W	656.84	K35S-7236120WS	1,155.59	K35T-7236120W	580.00	K35T-7236120WS	1,078.75
96" x 36" x 120"	5	140	K35S-9636120W	818.59	K35S-9636120WS	1,516.84	K35T-9636120W	741.75	K35T-9636120WS	1,440.00

Size W x D x H	# of Levels	Box Cap.	Starter Units w/o Boxes		Starter Units with Boxes		Add-On Units w/o Boxes		Add-On Units with Boxes	
			Model Number	Price Each	Model Number	Price Each	Model Number	Price Each	Model Number	Price Each
Single Box Depth - 24" Deep Boxes										
48" x 24" x 96"	4	24	K34S-4824096W	346.48	K34S-4824096WS	525.90	K34T-4824096W	288.76	K34T-4824096WS	468.18
72" x 24" x 96"	4	40	K34S-7224096W	454.67	K34S-7224096WS	753.71	K34T-7224096W	396.95	K34T-7224096WS	695.99
96" x 24" x 96"	4	56	K34S-9624096W	562.99	K34S-9624096WS	981.65	K34T-9624096W	505.27	K34T-9624096WS	923.93
48" x 24" x 120"	5	30	K35S-4824120W	431.37	K35S-4824120WS	655.65	K35T-4824120W	360.09	K35T-4824120WS	584.37
72" x 24" x 120"	5	50	K35S-7224120W	566.61	K35S-7224120WS	940.41	K35T-7224120W	495.33	K35T-7224120WS	869.13
96" x 24" x 120"	5	70	K35S-9624120W	702.01	K35S-9624120WS	1,225.33	K35T-9624120W	630.72	K35T-9624120WS	1,154.04
Double Box Depth - 24" Deep Boxes										
48" x 48" x 96"	4	48	K34S-4848096W	466.91	K34S-4848096WS	825.76	K34T-4848096W	390.96	K34T-4848096WS	749.81
72" x 48" x 96"	4	80	K34S-7248096W	616.98	K34S-7248096WS	1,215.06	K34T-7248096W	541.02	K34T-7248096WS	1,139.10
96" x 48" x 96"	4	112	K34S-9648096W	767.26	K34S-9648096WS	1,604.57	K34T-9648096W	691.30	K34T-9648096WS	1,528.61
48" x 48" x 120"	5	60	K35S-4848120W	492.23	K35S-4848120WS	940.79	K35T-4848120W	406.27	K35T-4848120WS	854.83
72" x 48" x 120"	5	100	K35S-7248120W	753.26	K35S-7248120WS	1,500.86	K35T-7248120W	667.30	K35T-7248120WS	1,414.90
96" x 48" x 120"	5	140	K35S-9648120W	941.10	K35S-9648120WS	1,987.74	K35T-9648120W	855.14	K35T-9648120WS	1,901.78

Boltless Archive Storage Units Features 3/4" Particle Board Decking

Organize your records neatly and efficiently with these heavy duty shelving units. Units can be ordered to accommodate either 15" deep or 24" deep archive boxes. Shelving units are priced with or without archive boxes.

Style A



42" - 3 Boxes Wide

Style B



69" - 5 Boxes Wide

Style C



42" - 3 Boxes Wide
69" - 5 Boxes Wide

Style A - Single Box Depth

Size W x D x H	Box Depth	# of Levels	Box Cap.	Units without Boxes		Units with Boxes	
				Model Number	Price	Model Number	Price
Units with 15" Deep Boxes							
42" x 15" x 60"	Single	5	15	3A5-4215-60W	153.63	3A5-4215-60WS	228.44
42" x 15" x 84"	Single	7	21	3A7-4215-84W	215.47	3A7-4215-84WS	320.21
Units with 24" Deep Boxes							
42" x 24" x 60"	Single	5	15	3A5-4224-60W	185.89	3A5-4224-60WS	298.03
42" x 24" x 84"	Single	7	21	3A7-4224-84W	260.02	3A7-4224-84WS	417.02

Style B - Single Box Depth

Size W x D x H	Box Depth	# of Levels	Box Cap.	Units without Boxes		Units with Boxes	
				Model Number	Price	Model Number	Price
Units with 15" Deep Boxes							
69" x 15" x 60"	Single	3	30	3B3-6915-60W	147.16	3B3-6915-60WS	296.78
69" x 15" x 84"	Single	4	40	3B4-6915-84W	198.16	3B4-6915-84WS	397.66
69" x 15" x 108"	Single	5	50	3B5-6915-108W	249.28	3B5-6915-108WS	498.66
Units with 24" Deep Boxes							
69" x 24" x 60"	Single	3	30	3B3-6924-60W	177.24	3B3-6924-60WS	401.52
69" x 24" x 84"	Single	4	40	3B4-6924-84W	238.27	3B4-6924-84WS	537.31
69" x 24" x 108"	Single	5	50	3B5-6924-108W	299.42	3B5-6924-108WS	673.22

Style C - Double Box Depth

Size W x D x H	Box Depth	# of Levels	Box Cap.	Units without Boxes		Units with Boxes	
				Model Number	Price	Model Number	Price
Units with 15" Deep Boxes							
42" x 30" x 60"	Double	3	18	3B3-4230-60WH	159.38	3B3-4230-60WHS	338.93
42" x 30" x 84"	Double	4	24	3B4-4230-84WH	214.45	3B4-4230-84WHS	453.85
69" x 30" x 60"	Double	3	60	3B3-6930-60WH	218.76	3B3-6930-60WHS	518.01
69" x 30" x 84"	Double	4	80	3B4-6930-84WH	293.62	3B4-6930-84WHS	692.62
69" x 30" x 108"	Double	5	100	3B5-6930-108WH	368.61	3B5-6930-108WHS	840.99
Units with 24" Deep Boxes							
42" x 48" x 60"	Double	3	18	3B3-4248-60WH	133.39	3B3-4248-60WHS	402.53
42" x 48" x 84"	Double	4	24	3B4-4248-84WH	179.80	3B4-4248-84WHS	538.65
69" x 48" x 60"	Double	3	60	3B3-6948-60WH	288.31	3B3-6948-60WHS	736.87
69" x 48" x 84"	Double	4	80	3B4-6948-84WH	386.36	3B4-6948-84WHS	984.44
69" x 48" x 108"	Double	5	100	3B5-6948-108WH	484.53	3B5-6948-108WHS	1,232.13

Medium Duty Cantilever Rack

Ideal for storing long products such as bars, pipes and rods. Available as either a single or double sided units. Two bases/columns, four brace beams and arms are required to make one free standing unit. All units are 79" tall. Arms are adjustable in 1½" increments. Choose either 12", 18" or 24" arms. Angled arms and welded end-stops provide secure/safe storage of long and/or irregular shaped merchandise. Connect multiple units to provide storage of extra long stock. Units assemble in less than 10 minutes.



Single Sided Unit



Double Sided Unit



Single Sided Base/Columns
Capacity 6,000 Lbs.

Arm Length	Model Number	Price Each
12"	215-GCS08012	171.83
18"	215-GCS08018	189.00
24"	215-GCS08024	226.78



Double Sided Base/Columns
Capacity 10,000 Lbs.

Arm Length	Model Number	Price Each
12"	215-GCD08012	194.21
18"	215-GCD08018	213.63
24"	215-GCD08024	256.36



Arms

Length	Arm Cap.	Model Number	Price Each
12"	1,000	215-GA12	16.28
18"	850	215-GA18	21.17
24"	650	215-GA24	28.65



Brace Beams

Length	Model Number	Price Each
36"	215-CBL30036	12.39
48"	215-CB30048	18.31
72"	215-CB30072	26.54

Wall Cantilever Rack

This Cantilever Rack is the ideal wall mounted solution that stores bar stock, lumber and more. Each cantilever section features 7 arms for highly flexible storage. Unit can store up to 100 lbs. per arm or a total capacity of 700 lbs. Mount a series of sections along a wall to accommodate storage for extremely long stock. Each cantilever section measures 60"H; three arms measure 15" with a 7¼" clearance; four 12" arms that feature 9" clearances. Features an attractive zinc plated finish. Assembles in minutes. Sold in single sections. Minimum 2 sections needed.



3 Sections Shown

Height	Model Number	Price Each
60"	215-WMC01	86.63

Vertical Stock Rack

Vertical Stock Racks store long pieces of stock vertically, while smaller sizes are kept on pan shelves. High strength tubular steel arms extend 8" from the frame. Pan shelves are spaced 21" apart. The unit's base is 36" wide x 24" deep. Unit is 84" high and has a capacity of 2,000 lbs.



W x D x H	Model Number	Price Each
36" x 24" x 84"	235-SRV1	242.41

Horizontal Stock Rack

Horizontal Stock Racks can be used individually or in conjunction with other horizontal stock racks, depending on the length of the stock to be stored. These units are 84" high x 22" square at bottom and are tapered to 4½" square at top. Angled steel arms are spaced every 8½" and extend 8" from uprights. Arm capacity 100 lbs. Unit Capacity 1,800 lbs

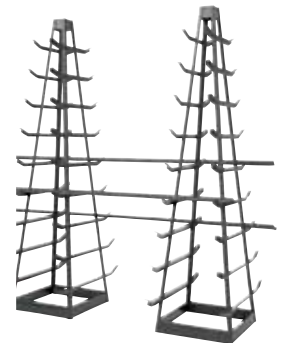

2 Units Shown

W x D x H	Model Number	Price Each
22" x 22" x 84"	235-SRH1	242.41

Heavy Duty Cantilever Rack

This cantilever rack is the ideal heavy duty storage for tubes, bar stock or other long materials. Available with either single or double sided base configurations. Columns are available in 8', 10' or 12' heights. Arms are available in 24", 36" or 48" lengths. Two bases/columns, one brace set and arms are required to make one free standing starter unit. Additional sections can be added to a starter unit by purchasing one additional base/column, one brace set and arms. All components are sold individually and are listed below

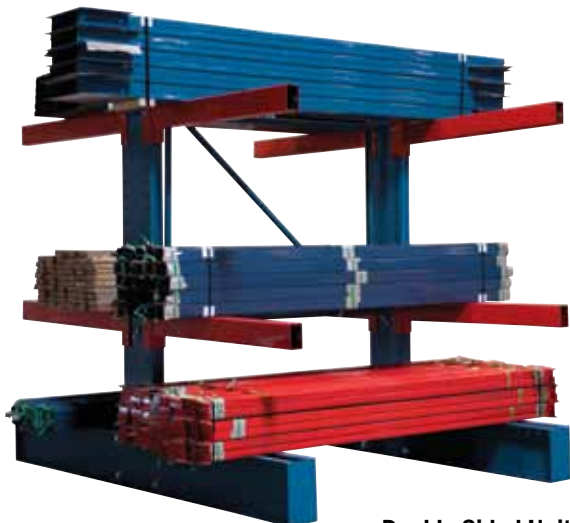

Double Sided Unit



Arm End-Stops

Provides secure and safe storage of long and/or irregular shaped merchandise. End-Stops Sold Separately.

*Fits Arm	Model Number	Price Each
4°	CHAHS01	9.16
20°	CHAHS02	9.16

*For use with Heavy Duty Arms only

How to Order

1. Select Arms

1. Choose Arm Length
2. Choose either Regular Duty or Heavy Duty based on required capacity

2. Select Base/Column Size

1. Choose either single sided or double sided base.
2. Choose column height:

When columns serve as load stops, it is necessary to specify column heights greater than the top loading arms.

There is no need to pay for extra column height unless load stops are desired or future expansion is anticipated

3. Select appropriate base for arms selected in Step 1 above.

3. Select Brace Set

1. A brace set must be installed between each pair of columns.

Step 1 - Arms

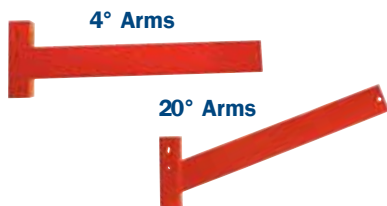

20° Arms			
Arm Length	Cap. Per Arm	Model Number	Price Each
Heavy Duty			
24"	2,200	215-HBH24	52.76
36"	2,050	215-HBH36	70.43
48"	1,600	215-HBH48	84.80

4° Arms			
Arm Length	Cap. Per Arm	Model Number	Price Each
Regular Duty			
24"	1,800	215-HR24	32.54
36"	1,200	215-HR36	41.08
48"	900	215-HR48	49.62
Heavy Duty			
36"	2,050	215-HRH36	64.03
48"	1,600	215-HRH48	77.09

Step 2 - Bases/Columns

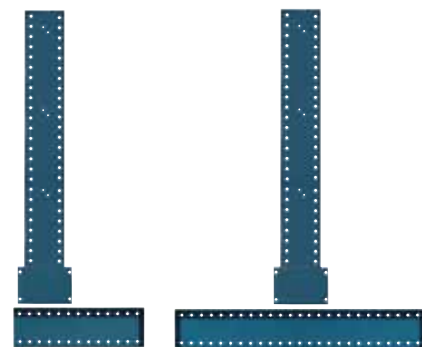

Single Sided

Double Sided

Single Sided Bases/Columns			
Arm Length	Cap. Per Column	Model Number	Price Each
8'H Column			
24"	11,200	CHS-09624	440.15
36"	8,400	CHS-09636	472.44
48"	6,700	CHS-09648	504.70
10'H Column			
24"	11,200	CHS-12024	504.44
36"	8,400	CHS-12036	536.71
48"	6,700	CHS-12048	569.00
12'H Column			
24"	11,200	CHS-14424	568.72
36"	8,400	CHS-14436	601.01
48"	6,700	CHS-14448	633.28

Double Sided Bases/Columns			
Arm Length	Cap. Per Column	Model Number	Price Each
8'H Column			
24"	22,400	CHD-09624	536.46
36"	16,800	CHD-09636	601.53
48"	13,400	CHD-09648	652.46
10'H Column			
24"	22,400	CHD-12024	600.74
36"	16,800	CHD-12036	665.82
48"	13,400	CHD-12048	716.75
12'H Column			
24"	22,400	CHD-14424	665.02
36"	16,800	CHD-14436	730.11
48"	13,400	CHD-14448	781.02

Step 3 - Brace Sets

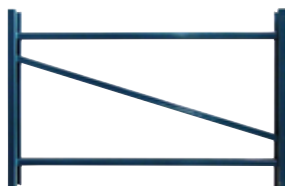

Width	8' & 10' High		12' High	
	Model Number	Price Each	Model Number	Price Each
3'	215-HXP36	48.73	215-CHX36	59.59
4'	215-HXP48	58.57	215-CHX48	73.50
6'	215-HXP72	79.08	215-CHX72	102.17
8'	215-HXP96	100.17	215-CHX96	131.40

Chrome Wire Shelving Units

Unlike other wire shelving on the market, our wire shelving is certified by the National Sanitation Foundation International. High quality chrome finish is very attractive and durable. Open wire construction reduces dust build-up, allows free light and air circulation, increases sprinkler effectiveness and improves visibility. Fast and easy to assemble. No tools required for assembly. Each shelf is adjustable in 1" increments. Units priced with 4 shelves and available in 63", 74" and 86" heights.



Add-On Units can be added using S-Hooks to create even shelf additions



Utilize common posts to connect multiple units

Shelf Size	Shelf Cap.	63" High		74" High		86" High		Model Number	Price Each	
		Model Number	Price Each	Model Number	Price Each	Model Number	Price Each			
4-Shelf Starter Units									Extra Shelf	
18" x 36"	500	WCS4-1836-63	186.40	WCS4-1836-74	194.50	WCS4-1836-86	205.01	205-CS1836	33.01	
18" x 48"	500	WCS4-1848-63	224.70	WCS4-1848-74	233.19	WCS4-1848-86	243.71	205-CS1848	42.69	
18" x 60"	400	WCS4-1860-63	254.05	WCS4-1860-74	262.14	WCS4-1860-86	272.66	205-CS1860	49.93	
18" x 72"	400	WCS4-1872-63	286.30	WCS4-1872-74	294.40	WCS4-1872-86	304.92	205-CS1872	57.99	
24" x 36"	500	WCS4-2436-63	221.88	WCS4-2436-74	229.98	WCS4-2436-86	240.49	205-CS2436	41.88	
24" x 48"	500	WCS4-2448-63	257.29	WCS4-2448-74	265.41	WCS4-2448-86	275.92	205-CS2448	50.75	
24" x 60"	400	WCS4-2460-63	305.62	WCS4-2460-74	313.73	WCS4-2460-86	324.24	205-CS2460	62.82	
24" x 72"	400	WCS4-2472-63	350.73	WCS4-2472-74	358.84	WCS4-2472-86	369.35	205-CS2472	74.10	
36" x 48"	500	WCS4-3648-63	423.17	WCS4-3648-74	431.27	WCS4-3648-86	441.79	205-CS3648	92.22	
36" x 60"	400	WCS4-3660-63	513.07	WCS4-3660-74	521.18	WCS4-3660-86	531.70	205-CS3660	114.69	
36" x 72"	300	WCS4-3672-63	568.12	WCS4-3672-74	576.22	WCS4-3672-86	586.74	205-CS3672	128.45	
4-Shelf Add-On Units									Extra Shelf	
18" x 36"	500	WCT4-1836-63	168.75	WCT4-1836-74	163.29	WCT4-1836-86	168.75	205-CS1836	33.01	
18" x 48"	500	WCT4-1848-63	197.91	WCT4-1848-74	201.98	WCT4-1848-86	207.24	205-CS1848	42.69	
18" x 60"	400	WCT4-1860-63	226.87	WCT4-1860-74	230.93	WCT4-1860-86	236.19	205-CS1860	49.93	
18" x 72"	400	WCT4-1872-63	259.15	WCT4-1872-74	263.19	WCT4-1872-86	268.45	205-CS1872	57.99	
24" x 36"	500	WCT4-2436-63	194.71	WCT4-2436-74	198.75	WCT4-2436-86	204.02	205-CS2436	41.88	
24" x 48"	500	WCT4-2448-63	230.13	WCT4-2448-74	234.18	WCT4-2448-86	239.44	205-CS2448	50.75	
24" x 60"	400	WCT4-2460-63	278.46	WCT4-2460-74	282.50	WCT4-2460-86	287.76	205-CS2460	62.82	
24" x 72"	400	WCT4-2472-63	323.56	WCT4-2472-74	327.62	WCT4-2472-86	332.88	205-CS2472	74.10	
36" x 48"	500	WCT4-3648-63	395.99	WCT4-3648-74	400.06	WCT4-3648-86	405.31	205-CS3648	92.22	
36" x 60"	400	WCT4-3660-63	485.90	WCT4-3660-74	489.97	WCT4-3660-86	495.23	205-CS3660	114.69	
36" x 72"	300	WCT4-3672-63	540.95	WCT4-3672-74	545.01	WCT4-3672-86	550.26	205-CS3672	128.45	

Chrome Plated Mobile Carts

These mobile wire carts are constructed to the highest quality standards and feature rust resistant chrome plating. Attractive open wire design reduces dust build-up and improves light and air circulation. Carts are highly maneuverable and come standard with 5" diameter swivel locking caster wheels. Fast and easy to assemble. No special tools are required. Shelves are fully adjustable in 1" increments. Cart capacity: 600 lbs. Available in 69" and 80" high mobile units that include 4 shelves.



Increase unit functionality by adding useful accessories (see page 34)

Featuring 5" casters with locking brakes.



Shelf Size	Shelf Cap.	69" High		80" High		Model Number	Price Each
		Model Number	Price Each	Model Number	Price Each		
4 Shelf Units						Extra Shelf	
18" x 36"	500	WCC4-1836-63	246.25	WCC4-1836-74	254.34	205-CS1836	33.01
18" x 48"	500	WCC4-1848-63	284.93	WCC4-1848-74	293.02	205-CS1848	42.69
18" x 60"	400	WCC4-1860-63	313.88	WCC4-1860-74	321.96	205-CS1860	49.93
18" x 72"	400	WCC4-1872-63	346.14	WCC4-1872-74	354.23	205-CS1872	57.99
24" x 36"	500	WCC4-2436-63	281.72	WCC4-2436-74	289.81	205-CS2436	41.88
24" x 48"	500	WCC4-2448-63	316.63	WCC4-2448-74	324.71	205-CS2448	50.75
24" x 60"	400	WCC4-2460-63	365.46	WCC4-2460-74	373.55	205-CS2460	62.82
24" x 72"	400	WCC4-2472-63	410.57	WCC4-2472-74	418.66	205-CS2472	74.10
36" x 48"	500	WCC4-3648-63	482.99	WCC4-3648-74	491.09	205-CS3648	92.22
36" x 60"	400	WCC4-3660-63	572.91	WCC4-3660-74	581.00	205-CS3660	114.69
36" x 72"	300	WCC4-3672-63	627.97	WCC4-3672-74	636.06	205-CS3672	128.45

Chrome Plated Service Carts

These attractive and highly functional service carts feature our chrome plated wire shelving and are built to provide years of dependable use. Open wire construction allows air circulation and reduces dust/dirt build-up. One piece "U" shaped handle is designed specifically for our service carts to provide added strength and rigidity. Shelves are adjustable in 1" increments. Carts include four 5" polyurethane swivel casters with an easy step brake. Cart capacity: 600 lbs.



Shelf Size	Shelf Cap.	2 Shelf Carts		3 Shelf Carts	
		Model Number	Price Each	Model Number	Price Each
18" x 36"	500	WCD2-1836	169.48	WCD3-1836	202.49
18" x 48"	500	WCD2-1848	188.81	WCD3-1848	231.50
18" x 60"	400	WCD2-1860	203.30	WCD3-1860	253.23
18" x 72"	400	WCD2-1872	219.43	WCD3-1872	277.43
24" x 36"	500	WCD2-2436	192.27	WCD3-2436	234.15
24" x 48"	500	WCD2-2448	209.97	WCD3-2448	260.72
24" x 60"	400	WCD2-2460	234.14	WCD3-2460	296.95
24" x 72"	400	WCD2-2472	256.68	WCD3-2472	330.79

Black Powder Coated Wire Shelving

Black powder coated wire shelving is made to the same high quality standards as our chrome wire shelving, but is substantially less expensive. The powder coated finish is rust and chip resistant offering a high level of durability. Wire shelving is highly attractive and functional. Wire design reduces dust build-up, improves visibility and increases sprinkler effectiveness.



Wire shelving units are very easy to assemble and do not require any special tools. Units can be assembled in less than 10 minutes. Shelves are fully adjustable in 1" increments. Posts include adjustable feet to accommodate uneven floors.

Units are available in 63", 74" and 86" heights and include 4 shelves per unit.

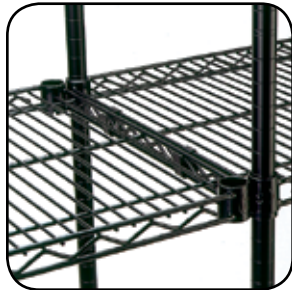

Add-On Units can be added using S-Hooks to create even shelf additions



Utilize common posts to connect multiple units



Shelf Size	Shelf Cap.	63" High		74" High		86" High		Model Number	Price Each
		Model Number	Price Each	Model Number	Price Each	Model Number	Price Each		
4-Shelf Starter Units								Extra Shelf	
18" x 36"	500	WBS4-1836-63	154.41	WBS4-1836-74	156.88	WBS4-1836-86	165.15	205-BS1836	27.74
18" x 48"	400	WBS4-1848-63	177.36	WBS4-1848-74	179.82	WBS4-1848-86	188.10	205-BS1848	33.48
18" x 60"	300	WBS4-1860-63	226.95	WBS4-1860-74	229.41	WBS4-1860-86	237.69	205-BS1860	45.87
18" x 72"	300	WBS4-1872-63	257.12	WBS4-1872-74	259.59	WBS4-1872-86	267.87	205-BS1872	53.41
24" x 36"	500	WBS4-2436-63	183.11	WBS4-2436-74	185.58	WBS4-2436-86	193.85	205-BS2436	34.92
24" x 48"	400	WBS4-2448-63	215.64	WBS4-2448-74	218.11	WBS4-2448-86	226.37	205-BS2448	43.04
24" x 60"	300	WBS4-2460-63	271.81	WBS4-2460-74	274.28	WBS4-2460-86	282.54	205-BS2460	57.10
24" x 72"	300	WBS4-2472-63	316.66	WBS4-2472-74	319.13	WBS4-2472-86	327.40	205-BS2472	68.30
4-Shelf Add-On Units								Extra Shelf	
18" x 36"	500	WBT4-1836-63	142.20	WBT4-1836-74	133.93	WBT4-1836-86	142.20	205-BS1836	27.74
18" x 48"	400	WBT4-1848-63	154.39	WBT4-1848-74	156.86	WBT4-1848-86	165.13	205-BS1848	33.48
18" x 60"	300	WBT4-1860-63	203.98	WBT4-1860-74	206.45	WBT4-1860-86	214.73	205-BS1860	45.87
18" x 72"	300	WBT4-1872-63	234.16	WBT4-1872-74	236.63	WBT4-1872-86	244.90	205-BS1872	53.41
24" x 36"	500	WBT4-2436-63	160.15	WBT4-2436-74	162.61	WBT4-2436-86	170.89	205-BS2436	34.92
24" x 48"	400	WBT4-2448-63	192.66	WBT4-2448-74	195.14	WBT4-2448-86	203.41	205-BS2448	43.04
24" x 60"	300	WBT4-2460-63	248.84	WBT4-2460-74	251.32	WBT4-2460-86	259.58	205-BS2460	57.10
24" x 72"	300	WBT4-2472-63	293.70	WBT4-2472-74	296.16	WBT4-2472-86	304.44	205-BS2472	68.30

Black Powder Coated Mobile Carts

These mobile wire shelving units are attractive and highly functional. Open wire design reduces dust build-up and improves air circulation. Carts include four 5" swivel casters. Black powder coated finish is chip and scratch resistant. Shelves are adjustable in 1" increments. Assembly is easy and does not require any special tools. Choose from heights of 69" or 80". Cart capacity: 600 lbs. Units now include locking casters at no additional charge.



Featuring 5" casters with locking brakes.

Shelf Size	Shelf Cap.	69" High		80" High			
		Model Number	Price Each	Model Number	Price Each	Model Number	Price Each
		4 Shelf		4 Shelf		Extra Shelf	
18" x 36"	500	WBC4-1836-63	214.24	WBC4-1836-74	216.68	205-BS1836	27.74
18" x 48"	400	WBC4-1848-63	237.22	WBC4-1848-74	239.65	205-BS1848	33.48
18" x 60"	300	WBC4-1860-63	286.78	WBC4-1860-74	289.21	205-BS1860	45.87
18" x 72"	300	WBC4-1872-63	316.93	WBC4-1872-74	319.37	205-BS1872	53.41
24" x 36"	500	WBC4-2436-63	242.97	WBC4-2436-74	245.41	205-BS2436	34.92
24" x 48"	400	WBC4-2448-63	275.44	WBC4-2448-74	277.87	205-BS2448	43.04
24" x 60"	300	WBC4-2460-63	331.67	WBC4-2460-74	334.11	205-BS2460	57.10
24" x 72"	300	WBC4-2472-63	376.49	WBC4-2472-74	378.92	205-BS2472	68.30

Black Service Carts

Highly functional service carts that are priced with 2 shelves. Carts are 36" high with a capacity of 600 lbs. Increase cart functionality by ordering extra shelves.



Shelf Size	Shelf Cap.				
		Model Number	Price Each	Model Number	Price Each
		2 Shelf		Extra Shelf	
18" x 36"	500	WBC2-1836-30	137.30	205-BS1836	27.74
18" x 48"	400	WBC2-1848-30	148.79	205-BS1848	33.48
18" x 60"	300	WBC2-1860-30	173.57	205-BS1860	45.87
18" x 72"	300	WBC2-1872-30	188.64	205-BS1872	53.41
24" x 36"	500	WBC2-2436-30	151.66	205-BS2436	34.92
24" x 48"	400	WBC2-2448-30	167.90	205-BS2448	43.04
24" x 60"	300	WBC2-2460-30	196.01	205-BS2460	57.10
24" x 72"	300	WBC2-2472-30	218.42	205-BS2472	68.30

Wire Shelving Components

Wire shelving components can be purchased separately to replace lost or damaged pieces or to allow you to create your own design. You can customize new or pre-owned units with our components that are interchangeable with most other major brands.



D x W	Model Number	Price Each
Chrome Wire Shelves		
18" x 36"	205-CS1836	33.01
18" x 48"	205-CS1848	42.69
18" x 60"	205-CS1860	49.93
18" x 72"	205-CS1872	57.99
24" x 36"	205-CS2436	41.88
24" x 48"	205-CS2448	50.75
24" x 60"	205-CS2460	62.82
24" x 72"	205-CS2472	74.10
36" x 48"	205-CS3648	92.22
36" x 60"	205-CS3660	114.69
36" x 72"	205-CS3672	128.45



Stationary Posts

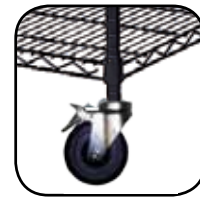

Mobile Posts
(caster not included)

Height	Chrome Posts		Black Posts	
	Model Number	Price Each	Model Number	Price Each
Stationary / Mobile Posts				
30"	N/A	N/A	205-BP30M	5.17
36"	205-CP36	6.17	205-BP36	6.22
63"	205-CP63X	13.59	205-BP63X	10.87
74"	205-CP74X	15.61	205-BP74X	11.49
86"	205-CP86	18.25	205-BP86	13.55



D x W	Model Number	Price Each
Black Wire Shelves		
18" x 36"	205-BS1836	27.74
18" x 48"	205-BS1848	33.48
18" x 60"	205-BS1860	45.87
18" x 72"	205-BS1872	53.41
24" x 36"	205-BS2436	34.92
24" x 48"	205-BS2448	43.04
24" x 60"	205-BS2460	57.10
24" x 72"	205-BS2472	68.30

Chrome Accessories – You can increase the functionality of new or pre-owned units with our accessories that are interchangeable with most other major brands.



(A) (B) (D) (F) (G)	(C) (E)	Description	Model Number	Price Each
Miscellaneous Components				
(A)		Locking 5" Swivel Caster	205-AC5L	15.29
(B)		Footplate	205-CPA	4.71
(C)		Post Foot (adjustable)	205-CPF	1.26
(D)		Shelf Clip (pair)	205-CSCLIP1	0.38
(E)		Post Mounting Bracket	205-CPMB	7.86
(F)		Chrome Post Connector	205-CPC	5.97
		Black Post Connector	205-BPC	5.34
(G)		S Style Hook for Chrome	205-CSHOOK1	1.59
		S Style Hook for Black	205-BSHOOK1	1.32



Flexible holders fit new or existing wire shelving with 1 1/4" face. Includes laserjet/inkjet white inserts

Length	Qty.	Model Number	Price Each
Snap-On Label Holders			
3"	25	205-CL1253	45.56
6"	25	205-CL1256	79.32

Size	Model Number	Price Each
(A) Chrome Shelf Dividers		
18"	205-CSD18	12.23
24"	205-CSD24	16.32
(B) Chrome Cantilever Shelves		
12" x 36"	205-CSC1236	20.21
12" x 48"	205-CSC1248	26.22
12" x 60"	205-CSC1260	30.35
(C) Chrome Ledges		
18"	205-CL18	4.16
24"	205-CL24	5.23
36"	205-CL36	7.50
48"	205-CL48	9.06
60"	205-CL60	10.78
(D) Chrome Safety Handles		
18"	205-CSF18	13.26
24"	205-CSF24	15.29
36"	205-CSF36	18.09
(E) Chrome U-Shaped Posts for Mobile Units		
18"	205-CH18	21.15
24"	205-CH24	23.66
(F) Chrome Document Holder		
N/A	205-CDH	18.87

Boltless Workbenches Features 3/4" Worksurface

These rugged workbenches utilize the Series 300B boltless design which provides high capacity and quick assembly. Ideal for assembly areas and shipping/receiving areas. Available in a variety of configurations and sizes to fit your specific needs. Workbenches come with your choice of 3/4" particle board or 3/4" laminated board worksurfaces. Worksurfaces are 36" high. Elevated shelves are 24" above worksurface and are 12" deep. Steel color: Gray.

Standard Workbench



W x D	Surface Cap.	3/4" Particle Board Decking		3/4" Laminated Board Decking	
		Model Number	Price Each	Model Number	Price Each
48" x 24"	1,000	3BW1-4824-W	66.60	3BW1-4824-L	77.13
48" x 30"	1,000	3BW1-4830-W	73.47	3BW1-4830-L	86.63
48" x 36"	1,000	3BW1-4836-W	86.05	3BW1-4836-L	101.83
48" x 48"	1,000	3BW1-4848-W	101.01	3BW1-4848-L	122.05
60" x 24"	750	3BW1-6024-W	77.43	3BW1-6024-L	90.58
60" x 30"	750	3BW1-6030-W	85.22	3BW1-6030-L	101.65
60" x 36"	1,250	3BW1-6036-W	98.69	3BW1-6036-L	118.43
60" x 48"	1,250	3BW1-6048-W	115.50	3BW1-6048-L	141.80
72" x 24"	600	3BW1-7224-W	85.92	3BW1-7224-L	101.70
72" x 30"	1,000	3BW1-7230-W	99.73	3BW1-7230-L	119.47
72" x 36"	1,000	3BW1-7236-W	109.02	3BW1-7236-L	132.70
72" x 48"	1,000	3BW1-7248-W	127.65	3BW1-7248-L	159.22
96" x 24"	600	3BW1-9624-W	107.94	3BW1-9624-L	128.98
96" x 30"	600	3BW1-9630-W	118.97	3BW1-9630-L	145.27
96" x 36"	600	3BW1-9636-W	130.07	3BW1-9636-L	161.65
96" x 48"	600	3BW1-9648-W	152.38	3BW1-9648-L	194.47

Workbench plus Bottom Shelf



W x D	Surface Cap.	3/4" Particle Board Decking		3/4" Laminated Board Decking	
		Model Number	Price Each	Model Number	Price Each
48" x 24"	1,000	3BW2-4824-W	87.76	3BW2-4824-L	108.82
48" x 30"	1,000	3BW2-4830-W	98.30	3BW2-4830-L	124.61
48" x 36"	1,000	3BW2-4836-W	120.35	3BW2-4836-L	151.91
48" x 48"	1,000	3BW2-4848-W	144.31	3BW2-4848-L	186.40
60" x 24"	750	3BW2-6024-W	104.64	3BW2-6024-L	130.96
60" x 30"	750	3BW2-6030-W	117.03	3BW2-6030-L	149.90
60" x 36"	1,250	3BW2-6036-W	140.87	3BW2-6036-L	180.35
60" x 48"	1,250	3BW2-6048-W	168.53	3BW2-6048-L	221.13
72" x 24"	600	3BW2-7224-W	118.42	3BW2-7224-L	149.98
72" x 30"	1,000	3BW2-7230-W	142.84	3BW2-7230-L	182.32
72" x 36"	1,000	3BW2-7236-W	158.32	3BW2-7236-L	205.67
72" x 48"	1,000	3BW2-7248-W	189.61	3BW2-7248-L	252.76
96" x 24"	600	3BW2-9624-W	155.76	3BW2-9624-L	197.84
96" x 30"	600	3BW2-9630-W	174.62	3BW2-9630-L	227.22
96" x 36"	600	3BW2-9636-W	193.73	3BW2-9636-L	256.87
96" x 48"	600	3BW2-9648-W	232.37	3BW2-9648-L	316.55

Workbench plus Top Shelf



W x D	Surface Cap.	3/4" Particle Board Decking		3/4" Laminated Board Decking	
		Model Number	Price Each	Model Number	Price Each
48" x 24"	1,000	3BW3-4824-W	100.78	3BW3-4824-L	116.57
48" x 30"	1,000	3BW3-4830-W	107.65	3BW3-4830-L	126.06
48" x 36"	1,000	3BW3-4836-W	120.23	3BW3-4836-L	141.27
48" x 48"	1,000	3BW3-4848-W	135.19	3BW3-4848-L	161.49
60" x 24"	750	3BW3-6024-W	118.20	3BW3-6024-L	137.94
60" x 30"	750	3BW3-6030-W	125.99	3BW3-6030-L	149.01
60" x 36"	1,250	3BW3-6036-W	139.46	3BW3-6036-L	165.78
60" x 48"	1,250	3BW3-6048-W	156.27	3BW3-6048-L	189.16
72" x 24"	600	3BW3-7224-W	131.75	3BW3-7224-L	155.42
72" x 30"	1,000	3BW3-7230-W	145.56	3BW3-7230-L	173.19
72" x 36"	1,000	3BW3-7236-W	154.85	3BW3-7236-L	186.42
72" x 48"	1,000	3BW3-7248-W	173.48	3BW3-7248-L	212.94
96" x 24"	600	3BW3-9624-W	164.13	3BW3-9624-L	195.70
96" x 30"	600	3BW3-9630-W	175.15	3BW3-9630-L	211.98
96" x 36"	600	3BW3-9636-W	186.26	3BW3-9636-L	228.36
96" x 48"	600	3BW3-9648-W	208.56	3BW3-9648-L	261.19

Workbench plus Top & Bottom Shelf



W x D	Surface Cap.	3/4" Particle Board Decking		3/4" Laminated Board Decking	
		Model Number	Price Each	Model Number	Price Each
48" x 24"	1,000	3BW4-4824-W	121.94	3BW4-4824-L	148.26
48" x 30"	1,000	3BW4-4830-W	132.48	3BW4-4830-L	164.05
48" x 36"	1,000	3BW4-4836-W	154.53	3BW4-4836-L	191.35
48" x 48"	1,000	3BW4-4848-W	178.49	3BW4-4848-L	225.83
60" x 24"	750	3BW4-6024-W	145.41	3BW4-6024-L	178.31
60" x 30"	750	3BW4-6030-W	157.80	3BW4-6030-L	197.25
60" x 36"	1,250	3BW4-6036-W	181.64	3BW4-6036-L	227.70
60" x 48"	1,250	3BW4-6048-W	209.30	3BW4-6048-L	268.49
72" x 24"	600	3BW4-7224-W	164.25	3BW4-7224-L	203.70
72" x 30"	1,000	3BW4-7230-W	188.67	3BW4-7230-L	236.04
72" x 36"	1,000	3BW4-7236-W	204.15	3BW4-7236-L	259.39
72" x 48"	1,000	3BW4-7248-W	235.44	3BW4-7248-L	306.47
96" x 24"	600	3BW4-9624-W	211.94	3BW4-9624-L	264.56
96" x 30"	600	3BW4-9630-W	230.80	3BW4-9630-L	293.94
96" x 36"	600	3BW4-9636-W	249.91	3BW4-9636-L	323.59
96" x 48"	600	3BW4-9648-W	288.55	3BW4-9648-L	383.27

Height Adjustable Industrial Workbenches

Durable steel height adjustable workbenches at a great value. Worksurface height from the floor can be adjusted from 31"–37". Available in a variety of configurations to fit your specific needs and budget. Choose from Shop Top or Steel worksurfaces. All welded steel legs are designed to support the most demanding applications. Elevated shelves are 12" above the worksurface and are 10" deep. Workbench capacity 1,000 lbs. Easy to assemble. Steel color: Gray.



Steel Top



Shop Top



Adjustable Leg Stand



Standard Workbench



Workbench plus Bottom Shelf

W x D	Capacity	Shop Top		Steel Top	
		Model Number	Price Each	Model Number	Price Each
60" x 30"	1,000	G55T-6030	283.12	G55S-6030	301.38
60" x 36"	1,000	G55T-6036	291.04	G55S-6036	326.17
72" x 30"	1,000	G55T-7230	296.38	G55S-7230	333.01
72" x 36"	1,000	G55T-7236	308.60	G55S-7236	353.42

W x D	Capacity	Shop Top		Steel Top	
		Model Number	Price Each	Model Number	Price Each
60" x 30"	1,000	G56T-6030	325.74	G56S-6030	343.98
60" x 36"	1,000	G56T-6036	333.66	G56S-6036	368.79
72" x 30"	1,000	G56T-7230	348.86	G56S-7230	385.49
72" x 36"	1,000	G56T-7236	361.07	G56S-7236	405.85



Workbench plus Bottom Shelf & Riser



Workbench plus Bottom Shelf, Riser & Drawer

W x D	Capacity	Shop Top		Steel Top	
		Model Number	Price Each	Model Number	Price Each
60" x 30"	1,000	G58T-6030	388.66	G58S-6030	406.90
60" x 36"	1,000	G58T-6036	396.57	G58S-6036	431.71
72" x 30"	1,000	G58T-7230	419.21	G58S-7230	455.84
72" x 36"	1,000	G58T-7236	431.42	G58S-7236	476.25

W x D	Capacity	Shop Top		Steel Top	
		Model Number	Price Each	Model Number	Price Each
60" x 30"	1,000	G59T-6030	656.28	G59S-6030	673.55
60" x 36"	1,000	G59T-6036	667.66	G59S-6036	702.79
72" x 30"	1,000	G59T-7230	686.84	G59S-7230	722.47
72" x 36"	1,000	G59T-7236	702.51	G59S-7236	747.34

FastRak™ Heavy Duty Workbenches

The FastRak™ workbench utilizes the same heavy-duty components as our popular FastRak™ bulk storage shelving. Great for heavy-duty applications including workshops, shipping/receiving areas and assembly lines. These workbenches are extremely rugged and can support up to 1,800 lbs. on a 72" wide unit. Thick 3/4" particle board fits inside step beams to create a flush worksurface that is approximately 36" high. Workbench utilizes steel supports for an exceptionally strong worksurface. Easy to assemble: Heavy-duty step load beams lock into one-piece and upright legs come assembled and are included in price shown below. Anchor uprights to the floor with optional Deluxe Footplates (see page 19 for footplate pricing).



3/4" Particle Board Decking

3/4" Laminated Board Decking

W x D	Shelf Cap.	Workbench		Workbench w/Bottom Shelf		Workbench		Workbench w/Bottom Shelf	
		Model Number	Price Each	Model Number	Price Each	Model Number	Price Each	Model Number	Price Each
48" x 36"	2,000	KB1-4836-W	180.21	KB2-4836-W	230.20	KB1-4836-L	196.04	KB2-4836-L	261.83
48" x 48"	2,000	KB1-4848-W	208.86	KB2-4848-W	269.28	KB1-4848-L	229.90	KB2-4848-L	311.41
72" x 36"	1,800	KB1-7236-W	220.78	KB2-7236-W	294.85	KB1-7236-L	244.47	KB2-7236-L	342.24
72" x 48"	1,800	KB1-7248-W	254.63	KB2-7248-W	344.37	KB1-7248-L	286.21	KB2-7248-L	407.51
96" x 36"	1,600	KB1-9636-W	261.35	KB2-9636-W	359.51	KB1-9636-L	292.97	KB2-9636-L	422.73
96" x 48"	1,600	KB1-9648-W	300.43	KB2-9648-W	419.44	KB1-9648-L	342.55	KB2-9648-L	503.69

Premier Workbenches

Our premier workbench features a rugged 1 1/4" thick shop top worksurface. The worksurface is approximately 36"H. The heavy-duty steel components and extra thick worksurface allow this workbench to support a full 1,000 lbs. per shelf. Perfect for a wide variety of industrial applications such as assembly lines or labs. Shop top color: Brown. Steel color: Gray.



W x D	Shelf Cap.	Workbench		Workbench w/Bottom Shelf	
		Model Number	Price Each	Model Number	Price Each
60" x 30"	1,000	BWH1-6030-WT	243.09	BWH2-6030-WT	425.08
60" x 36"	1,000	BWH1-6036-WT	267.87	BWH2-6036-WT	471.53
72" x 30"	1,000	BWH1-7230-WT	296.48	BWH2-7230-WT	528.65
72" x 36"	1,000	BWH1-7236-WT	321.26	BWH2-7236-WT	574.48



Series 200B Stationary Bin Storage Units

Jumbo bin storage units come complete with bins. Bins are made of heavy duty polypropylene and are unaffected by water, grease and oil. Shelving features a heavy duty industrial boltless design which provides for quick, easy assembly and years of dependable service. These units are a cost effective way to store small, medium and large parts. Shelving comes complete with bins and particle board decking. Features 1/2" particle board decking.



Enhance bin functionality by purchasing bin dividers and windows (see page 40)

Bin D x W x H	Unit W x D x H	Bins Per Level	# of Levels w/Bins	Total # of Bins	# of Shelves	Model Number	Price Each
12"D Bins							
10 ⁷ / ₈ " x 5 ¹ / ₂ " x 5"	36" x 12" x 72"	6	7	42	8	QR1-(B/Y/R)230*	412.71
10 ⁷ / ₈ " x 5 ¹ / ₂ " x 5"	48" x 12" x 72"	8	7	56	8	QR2-(B/Y/R)230*	524.24
10 ⁷ / ₈ " x 5 ¹ / ₂ " x 5"	60" x 12" x 72"	10	7	70	8	QR3-(B/Y/R)230*	649.97
10 ⁷ / ₈ " x 5 ¹ / ₂ " x 5"	72" x 12" x 72"	12	7	84	8	QR4-(B/Y/R)230*	747.64
10 ⁷ / ₈ " x 5 ¹ / ₂ " x 5"	96" x 12" x 72"	16	7	112	8	QR5-(B/Y/R)230*	992.21
10 ⁷ / ₈ " x 11" x 5"	36" x 12" x 72"	3	7	21	8	QR1-(B/Y/R)235*	355.38
10 ⁷ / ₈ " x 11" x 5"	48" x 12" x 72"	4	7	28	8	QR2-(B/Y/R)235*	447.80
10 ⁷ / ₈ " x 11" x 5"	60" x 12" x 72"	5	7	35	8	QR3-(B/Y/R)235*	554.42
10 ⁷ / ₈ " x 11" x 5"	72" x 12" x 72"	6	7	42	8	QR4-(B/Y/R)235*	632.98
10 ⁷ / ₈ " x 11" x 5"	96" x 12" x 72"	8	7	56	8	QR5-(B/Y/R)235*	839.33
10 ³ / ₄ " x 8 ³ / ₄ " x 7"	36" x 12" x 72"	4	6	24	7	QR1-(B/Y/R)239*	375.81
10 ³ / ₄ " x 8 ³ / ₄ " x 7"	48" x 12" x 72"	5	6	30	7	QR2-(B/Y/R)239*	459.04
10 ³ / ₄ " x 8 ³ / ₄ " x 7"	60" x 12" x 72"	7	6	42	7	QR3-(B/Y/R)239*	669.90
10 ³ / ₄ " x 8 ³ / ₄ " x 7"	72" x 12" x 72"	8	6	48	7	QR4-(B/Y/R)239*	678.97
10 ³ / ₄ " x 8 ³ / ₄ " x 7"	96" x 12" x 72"	11	6	66	7	QR5-(B/Y/R)239*	917.43
15"D Bins							
14 ³ / ₄ " x 8 ¹ / ₂ " x 7"	36" x 15" x 72"	4	6	24	7	QR1-(B/Y/R)240*	445.04
14 ³ / ₄ " x 8 ¹ / ₂ " x 7"	48" x 15" x 72"	5	6	30	7	QR2-(B/Y/R)240*	545.11
14 ³ / ₄ " x 8 ¹ / ₂ " x 7"	60" x 15" x 72"	7	6	42	7	QR3-(B/Y/R)240*	804.48
14 ³ / ₄ " x 8 ¹ / ₂ " x 7"	72" x 15" x 72"	8	6	48	7	QR4-(B/Y/R)240*	827.15
14 ³ / ₄ " x 8 ¹ / ₂ " x 7"	96" x 15" x 72"	11	6	66	7	QR5-(B/Y/R)240*	1,100.15
14 ³ / ₄ " x 16 ¹ / ₂ " x 7"	36" x 15" x 72"	2	6	12	7	QR1-(B/Y/R)250*	374.48
14 ³ / ₄ " x 16 ¹ / ₂ " x 7"	60" x 15" x 72"	3	6	18	7	QR3-(B/Y/R)250*	551.90
14 ³ / ₄ " x 16 ¹ / ₂ " x 7"	72" x 15" x 72"	4	6	24	7	QR4-(B/Y/R)250*	686.03
14 ³ / ₄ " x 16 ¹ / ₂ " x 7"	96" x 15" x 72"	5	6	30	7	QR5-(B/Y/R)250*	856.02
18"D Bins							
18" x 11" x 10"	36" x 18" x 72"	3	5	15	6	QR1-(B/Y/R)260*	478.44
18" x 11" x 10"	48" x 18" x 72"	4	5	20	6	QR2-(B/Y/R)260*	612.59
18" x 11" x 10"	60" x 18" x 72"	5	5	25	6	QR3-(B/Y/R)260*	757.26
18" x 11" x 10"	72" x 18" x 72"	6	5	30	6	QR4-(B/Y/R)260*	893.05
18" x 11" x 10"	96" x 18" x 72"	8	5	40	6	QR5-(B/Y/R)260*	1,165.75
18" x 16 ¹ / ₂ " x 11"	36" x 18" x 72"	2	4	8	5	QR1-(B/Y/R)270*	367.23
18" x 16 ¹ / ₂ " x 11"	60" x 18" x 72"	3	4	12	5	QR3-(B/Y/R)270*	537.25
18" x 16 ¹ / ₂ " x 11"	72" x 18" x 72"	4	4	16	5	QR4-(B/Y/R)270*	675.15
18" x 16 ¹ / ₂ " x 11"	96" x 18" x 72"	5	4	20	5	QR5-(B/Y/R)270*	840.08

Series 200B Mobile Bin Storage Units

Mobile bin storage units come complete with bins. These highly functional mobile shelf carts are built to last. Heavy duty steel construction ensures years of dependable service. Bins are made of heavy duty polypropylene and are unaffected by water, grease and oil. These mobile units include four heavy duty 5" casters (two swivel and two rigid). Unit height 78". Steel color: Gray. Cart capacity: 600 lbs. Features 1/2" particle board decking.



Advanced boltless shelf design that utilizes the strength of double rivet beams



Bin D x W x H	Unit W x D x H	Bins Per Level	# of Levels w/Bins	Total # of Bins	# of Shelves	Model Number	Price Each
Single Sided - 12"D Mobile Bin Units							
10 $\frac{1}{8}$ " x 5 $\frac{1}{2}$ " x 5"	36" x 12" x 78"	6	7	42	8	QL1-(B/Y/R)230*	517.51
10 $\frac{1}{8}$ " x 5 $\frac{1}{2}$ " x 5"	48" x 12" x 78"	8	7	56	8	QL2-(B/Y/R)230*	639.68
10 $\frac{1}{8}$ " x 11" x 5"	36" x 12" x 78"	3	7	21	8	QL1-(B/Y/R)235*	460.18
10 $\frac{1}{8}$ " x 11" x 5"	48" x 12" x 78"	4	7	28	8	QL2-(B/Y/R)235*	563.24
10 $\frac{3}{4}$ " x 8 $\frac{3}{4}$ " x 7"	36" x 12" x 78"	4	6	24	7	QL1-(B/Y/R)239*	480.61
10 $\frac{3}{4}$ " x 8 $\frac{3}{4}$ " x 7"	48" x 12" x 78"	5	6	30	7	QL2-(B/Y/R)239*	574.48
Double Sided - 24"D Mobile Bin Units							
811.93	36" x 24" x 78"	12	7	84	8	QLD1-(B/Y/R)230*	811.93
1,014.16	48" x 24" x 78"	16	7	112	8	QLD2-(B/Y/R)230*	1,014.16
697.27	36" x 24" x 78"	6	7	42	8	QLD1-(B/Y/R)235*	697.27
861.28	48" x 24" x 78"	8	7	56	8	QLD2-(B/Y/R)235*	861.28
749.55	36" x 24" x 78"	8	6	48	7	QLD1-(B/Y/R)239*	749.55
898.18	48" x 24" x 78"	10	6	60	7	QLD2-(B/Y/R)239*	898.18
1,173.60	60" x 24" x 78"	14	6	84	7	QLD3-(B/Y/R)239*	1,173.60
Single Sided - 18"D Mobile Bin Units							
18" x 11" x 10"	36" x 18" x 78"	3	5	15	6	QL1-(B/Y/R)260*	595.31
18" x 11" x 10"	48" x 18" x 78"	4	5	20	6	QL2-(B/Y/R)260*	739.43
18" x 11" x 10"	60" x 18" x 78"	5	5	25	6	QL3-(B/Y/R)260*	894.09
18" x 16 $\frac{1}{2}$ " x 11"	36" x 18" x 78"	2	4	8	5	QL1-(B/Y/R)270*	545.14
18" x 16 $\frac{1}{2}$ " x 11"	60" x 18" x 78"	3	4	12	5	QL3-(B/Y/R)270*	707.12
Double Sided - 36"D Mobile Bin Units							
18" x 11" x 10"	48" x 36" x 78"	8	5	30	6	QLD2-(B/Y/R)260*	1,036.70
18" x 11" x 10"	60" x 36" x 78"	10	5	40	6	QLD3-(B/Y/R)260*	1,300.11
18" x 16 $\frac{1}{2}$ " x 11"	60" x 36" x 78"	6	4	24	5	QLD3-(B/Y/R)270*	1,087.75

Stackable Bins

Stackable bins are made of heavy duty polypropylene with permanent molded-in color. They are virtually unbreakable and are water, rust and corrosion-proof. Ideal for assembly, production, manufacturing or repair areas. Finger grips are provided for ease of handling. Bin fronts have a large slotted label area. Reinforced ribs prevent bins from spreading under loads. Clear plastic windows are available to increase bin storage capacity while maintaining easy visibility of bin contents. Enhance bin functionality by adding optional bin dividers. Choose from 9 different sizes and 3 different colors (Blue, Yellow & Red). Sold in carton quantities only.

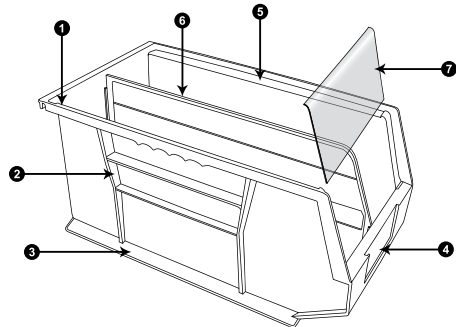
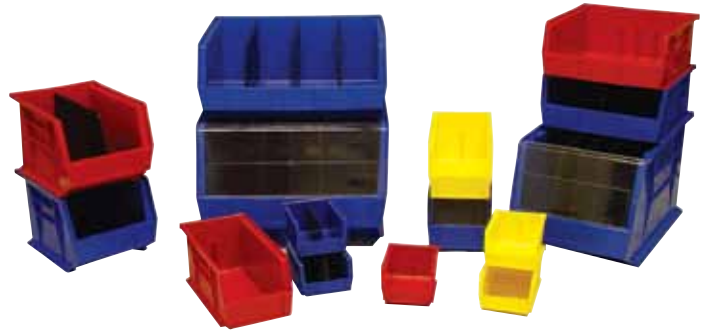

1. Full length hanger
2. Side reinforcing rib design
3. Extra-wide stacking ledge
4. Large front label slots
5. Anti-slid stop to prevent shifting
6. Optional Divider
7. Optional see thru window

Clear Plastic Windows

Fits Bin	Ctn. Qty.	Model Number	Price Each
225-QTB230	12	225-QTAW230	1.17
225-QTB235	6	225-QTAW235	1.66
225-QTB239/240	6	225-QTAW239/240	1.53
225-QTB250	6	225-QTAW250	3.36
225-QTB260	4	225-QTAW260	2.84
225-QTB270	3	225-QTAW270	4.02

Stackable Bins

Outside D x W x H	Ctn. Qty.	Blue Bins	Yellow Bins	Red Bins	Price Each
5 $\frac{3}{8}$ " x 4 $\frac{1}{8}$ " x 3"	24	225-QTB210	225-QTY210	225-QTR210	1.32
7 $\frac{3}{8}$ " x 4 $\frac{1}{8}$ " x 3"	24	225-QTB220	225-QTY220	225-QTR220	2.11
10 $\frac{7}{8}$ " x 5 $\frac{1}{2}$ " x 5"	12	225-QTB230	225-QTY230	225-QTR230	5.51
10 $\frac{7}{8}$ " x 11" x 5"	6	225-QTB235	225-QTY235	225-QTR235	8.30
10 $\frac{3}{4}$ " x 8 $\frac{1}{4}$ " x 7"	6	225-QTB239	225-QTY239	225-QTR239	8.86
14 $\frac{3}{4}$ " x 8 $\frac{1}{2}$ " x 7"	12	225-QTB240	225-QTY240	225-QTR240	11.29
14 $\frac{3}{4}$ " x 16 $\frac{1}{2}$ " x 7"	6	225-QTB250	225-QTY250	225-QTR250	16.70
18" x 11" x 10"	4	225-QTB260	225-QTY260	225-QTR260	20.90
18" x 16 $\frac{1}{2}$ " x 11"	3	225-QTB270	225-QTY270	225-QTR270	27.95

Bin Dividers

Fits Bin	Ctn. Qty.	Model Number	Price Each
225-QTB210	6	225-QTAD210	0.89
225-QTB220	6	225-QTAD220	1.00
225-QTB230/235	6	225-QTAD230/235	1.53
225-QTB239	6	225-QTAD239	1.89
225-QTB240/250	6	225-QTAD240/250	2.60
225-QTB260	6	225-QTAD260	4.66
225-QTB270	6	225-QTAD270	5.00

Plastic Bins

These durable polypropylene bins are designed for either 12", 18" or 24" deep shelving units. Polypropylene bins outlast corrugated and pay for themselves in reduced replacement costs. Bins are waterproof and unaffected by grease and oil. Front of bins have a large label area. Optional bin cups are available and easily fit into all bins. Bin dividers can also be ordered to increase bin functionality by separating small parts and supplies. Sold in carton quantity only.



Bin Cups



Bin Dividers



Bin Dividers

Divider Color	Ctn. Qty.	Model Number	Price Each
Black	24	225-SBD4	0.42
Black	24	225-SBD6	0.48
Black	24	225-SBD8	1.05

Bin Cups

Outside W x D x H	Ctn. Qty.	Model Number	Price Each
3 $\frac{1}{4}$ " x 1 $\frac{7}{8}$ " x 3"	100	225-SBC1	0.45

Size W x D x H	Ctn. Qty.	Model Number	Price Each
4" x 11 $\frac{1}{2}$ " x 4"	24	225-SB124	1.71
6" x 11 $\frac{1}{2}$ " x 4"	24	225-SB126	2.67
8" x 11 $\frac{1}{2}$ " x 4"	24	225-SB128	2.87
4" x 17 $\frac{1}{2}$ " x 4"	24	225-SB184	2.30
6" x 17 $\frac{1}{2}$ " x 4"	24	225-SB186	3.26

Corrugated Bins

An economical way to store and organize small or loose parts. These rugged bins are constructed of 200 lb. test corrugated board. The bins fold together quickly and are ready for use in seconds. Sold 100 bins per carton only. Priced per bin.



Size W x D x H	Ctn. Qty.	Model Number	Price Each
4" x 12" x 4"	100	225-BC124	0.91
6" x 12" x 4"	100	225-BC126	1.06
8" x 12" x 4"	100	225-BC128	1.17
4" x 18" x 4"	100	225-BC184	1.39
6" x 18" x 4"	100	225-BC186	1.49

Bin Shelving Units

These handy bin units are great for organizing your small parts. Utilizing the heavy duty construction of our 200A Boltless Shelving system using industrial strength steel components and particle board decking. Available with your choice of plastic or corrugated bins. Units come complete with shelving and bins. Units available with 12" or 18" deep bins. Features 1/2" particle board decking.



Increase bin functionality with bin cups & dividers (see page 40).



Bin W x D x H	Unit W x D x H	Bins Per Level	Total # of Bins	Plastic Bin Units		Corrugated Bin Units	
				Model Number	Price Each	Model Number	Price Each
36"H Units							
4" x 12" x 4"	36" x 12" x 36"	8	40	A6-3612-36W-SB4	164.68	A6-3612-36W-CB4	132.98
6" x 12" x 4"	36" x 12" x 36"	5	25	A6-3612-36W-SB6	163.04	A6-3612-36W-CB6	122.98
8" x 12" x 4"	36" x 12" x 36"	4	20	A6-3612-36W-SB8	153.93	A6-3612-36W-CB8	119.94
4" x 18" x 4"	36" x 18" x 36"	8	40	A6-3618-36W-SB4	203.31	A6-3618-36W-CB4	166.39
6" x 18" x 4"	36" x 18" x 36"	5	25	A6-3618-36W-SB6	192.63	A6-3618-36W-CB6	148.47
72"H Units							
4" x 12" x 4"	36" x 12" x 72"	8	88	A12-3612-72WSB4	328.01	A12-3612-72WCB4	258.68
6" x 12" x 4"	36" x 12" x 72"	5	55	A12-3612-72WSB6	324.40	A12-3612-72WCB6	236.62
8" x 12" x 4"	36" x 12" x 72"	4	44	A12-3612-72WSB8	304.36	A12-3612-72WCB8	229.57
4" x 18" x 4"	36" x 18" x 72"	8	88	A12-3618-72WSB4	407.36	A12-3618-72WCB4	326.55
6" x 18" x 4"	36" x 18" x 72"	5	55	A12-3618-72WSB6	383.87	A12-3618-72WCB6	286.59
4" x 12" x 4"	36" x 12" x 72"	8	40	A12-3612-72WSBC	326.04	A12-3612-72WCBC	246.65
6" x 12" x 4"		5	30				
4" x 18" x 4"	36" x 18" x 72"	8	40	A12-3618-72WSBC	394.55	A12-3618-72WCBC	304.75
6" x 18" x 4"		5	30				

Pick Racks

Pick racks are highly functional and feature angled shelves for easy visibility and quick access to parts and supplies. Available with your choice of plastic or corrugated bins. Units are 12" deep and are available with either 4", 6", or 8" wide bins.

Bin W x D x H	Total # of Bins	Pick Rack w/Plastic Bins		Pick Racks w/Corrugated Bins	
		Model Number	Price Each	Model Number	Price Each
Bench Rack					
4" x 12" x 4"	24	PRB-SB4	140.25	PRB-CB4	121.10
6" x 12" x 4"	15	PRB-SB6	139.18	PRB-CB6	115.08
8" x 12" x 4"	12	PRB-SB8	133.57	PRB-CB8	113.16
Rack Only	n/a	235-PRB1	99.17	235-PRB1	99.17
Floor Rack					
4" x 12" x 4"	64	PRF-SB4	341.45	PRF-CB4	290.38
6" x 12" x 4"	40	PRF-SB6	338.59	PRF-CB6	274.33
8" x 12" x 4"	32	PRF-SB8	323.64	PRF-CB8	269.21
Rack Only	n/a	235-PRF1	231.91	235-PRF1	231.91

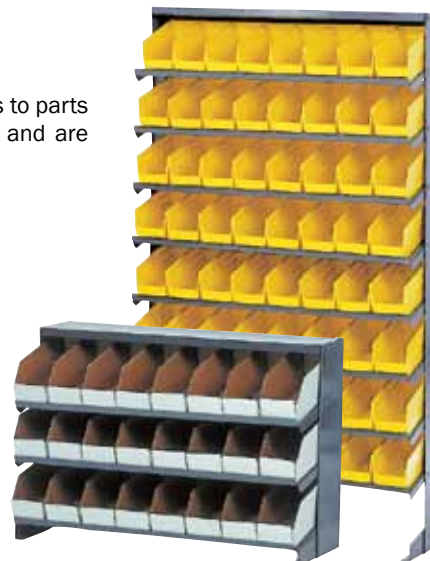

Chrome Wire Shelving with Plastic Small Parts Bins

Combine looks and function with these high quality chrome bin storage units. Available in a variety of sizes and colors to meet your specific needs and color preferences. Bins are reinforced for added strength and durability. Bin dividers can be added to the bins to separate small parts (see page 40 for pricing). Finger grips on bins allow for easy handling.

Mobile units glide easily on four locking industrial grade 5" casters.



Increase bin functionality with bin cups & dividers (see page 40).



Stationary Units

Bin D x W x H	Unit W x D x H	Bins Per Level	# of Levels w/Bins	Total # of Bins	# of Shelves	Model Number	Price Each
36" High Units - Single Sided							
4" x 12" x 4"	36" x 12" x 36"	8	5	40	6	WCS6-123636-S4	258.09
6" x 12" x 4"	36" x 12" x 36"	5	5	25	6	WCS6-123636-S6	256.31
8" x 12" x 4"	36" x 12" x 36"	4	5	20	6	WCS6-123636-S8	246.96
4" x 18" x 4"	36" x 18" x 36"	8	5	40	6	WCS6-183636-S4	320.29
6" x 18" x 4"	36" x 18" x 36"	5	5	25	6	WCS6-183636-S6	309.69
8" x 18" x 4"	36" x 18" x 36"	4	5	20	6	WCS6-183636-S8	335.83
4" x 24" x 4"	36" x 24" x 36"	8	5	40	6	WCS6-243636-S4	486.93
6" x 24" x 4"	36" x 24" x 36"	5	5	25	6	WCS6-243636-S6	481.57
8" x 24" x 4"	36" x 24" x 36"	4	5	20	6	WCS6-243636-S8	453.54
74" High Units - Single Sided							
4" x 12" x 4"	36" x 12" x 74"	8	11	40	12	WCS12-123674-S4	531.85
6" x 12" x 4"	36" x 12" x 74"	5	11	25	12	WCS12-123674-S6	527.92
8" x 12" x 4"	36" x 12" x 74"	4	11	20	12	WCS12-123674-S8	507.36
4" x 18" x 4"	36" x 18" x 74"	8	11	40	12	WCS12-183674-S4	660.95
6" x 18" x 4"	36" x 18" x 74"	5	11	25	12	WCS12-183674-S6	637.62
8" x 18" x 4"	36" x 18" x 74"	4	11	20	12	WCS12-183674-S8	695.14
4" x 24" x 4"	36" x 24" x 74"	8	11	40	12	WCS12-243674-S4	1,016.90
6" x 24" x 4"	36" x 24" x 74"	5	11	25	12	WCS12-243674-S6	1,005.12
8" x 24" x 4"	36" x 24" x 74"	4	11	20	12	WCS12-243674-S8	943.45

Mobile Units

Bin D x W x H	Unit W x D x H	Bins Per Level	# of Levels w/Bins	Total # of Bins	# of Shelves	Model Number	Price Each
42" High Units - Double Sided							
4" x 12" x 4"	36" x 24" x 42"	16	5	80	6	WCC6-243642-S4	510.49
6" x 12" x 4"	36" x 24" x 42"	10	5	50	6	WCC6-243642-S6	506.92
8" x 12" x 4"	36" x 24" x 42"	8	5	40	6	WCC6-243642-S8	488.23
80" High Units - Double Sided							
4" x 12" x 4"	36" x 24" x 80"	16	11	176	12	WCC12-243680-S4	926.10
6" x 12" x 4"	36" x 24" x 80"	10	11	110	12	WCC12-243680-S6	918.25
8" x 12" x 4"	36" x 24" x 80"	8	11	88	12	WCC12-243680-S8	877.13

Mobile Shelving with Plastic or Corrugated Small Parts Bins

These highly functional mobile shelf carts are complete with either plastic or corrugated small parts bins. Units are available in single or double sided configurations to fit your needs. Heavy duty steel construction insures years of dependable service and allows easy transport of bins to work areas. Heavy-duty mobile shelf carts feature 5" casters (2 swivel and 2 rigid). Steel color: Powder coated gray. Cart capacity: 600 lbs. Features 1/2" particle board decking.



Bin D x W x H	Unit W x D x H	Bins Per Level	# of Levels w/Bins	Total # of Bins	# of Shelves	Mobile Shelving w/ Plastic Bins		Mobile Shelving w/ Corrugated Bins		
						Model Number	Price Each	Model Number	Price Each	
37" High Units - Single Sided										
4" x 12" x 4"	48" x 12" x 37"	11	4	44	5	CA5-4812-30W-S4	295.90	CA5-4812-30W-C4	260.79	
6" x 12" x 4"	48" x 12" x 37"	7	4	28	5	CA5-4812-30W-S6	295.27	CA5-4812-30W-C6	250.29	
8" x 12" x 4"	48" x 12" x 37"	5	4	20	5	CA5-4812-30W-S8	277.92	CA5-4812-30W-C8	243.90	
4" x 18" x 4"	48" x 18" x 37"	11	4	44	5	CA5-4818-30W-S4	347.61	CA5-4818-30W-C4	307.42	
6" x 18" x 4"	48" x 18" x 37"	7	4	28	5	CA5-4818-30W-S6	337.58	CA5-4818-30W-C6	288.18	
37" High Units - Double Sided										
4" x 12" x 4"	48" x 24" x 37"	22	4	88	5	CA5-4824-30W-S4	422.16	CA5-4824-30W-C4	351.94	
6" x 12" x 4"	48" x 24" x 37"	14	4	56	5	CA5-4824-30W-S6	420.90	CA5-4824-30W-C6	330.94	
8" x 12" x 4"	48" x 24" x 37"	10	4	40	5	CA5-4824-30W-S8	386.21	CA5-4824-30W-C8	318.17	
4" x 18" x 4"	48" x 36" x 37"	22	4	88	5	CA5-4836-30W-S4	529.75	CA5-4836-30W-C4	449.36	
6" x 18" x 4"	48" x 36" x 37"	14	4	56	5	CA5-4836-30W-S6	509.67	CA5-4836-30W-C6	410.89	
67" High Units - Single Sided										
4" x 12" x 4"	48" x 12" x 67"	11	8	88	9	CA9-4812-60W-S4	440.55	CA9-4812-60W-C4	370.32	
6" x 12" x 4"	48" x 12" x 67"	7	8	56	9	CA9-4812-60W-S6	439.29	CA9-4812-60W-C6	349.32	
8" x 12" x 4"	48" x 12" x 67"	5	8	40	9	CA9-4812-60W-S8	404.60	CA9-4812-60W-C8	336.56	
4" x 18" x 4"	48" x 18" x 67"	11	8	88	9	CA9-4818-60W-S4	528.59	CA9-4818-60W-C4	448.20	
6" x 18" x 4"	48" x 18" x 67"	5	8	56	9	CA9-4818-60W-S6	508.52	CA9-4818-60W-C6	409.73	
67" High Units - Double Sided										
4" x 12" x 4"	48" x 24" x 37"	22	8	176	9	CA9-4824-60W-S4	663.03	CA9-4824-60W-C4	522.59	
6" x 12" x 4"	48" x 24" x 37"	14	8	112	9	CA9-4824-60W-S6	660.51	CA9-4824-60W-C6	480.59	
8" x 12" x 4"	48" x 24" x 37"	10	8	80	9	CA9-4824-60W-S8	591.13	CA9-4824-60W-C8	455.05	
4" x 18" x 4"	48" x 36" x 37"	22	8	176	9	CA9-4836-60W-S4	843.36	CA9-4836-60W-C4	682.58	
6" x 18" x 4"	48" x 36" x 37"	10	8	112	9	CA9-4836-60W-S6	803.21	CA9-4836-60W-C6	605.64	

Mobile Workbenches

Save time and money with these handy mobile workbenches. Workbench easily rolls on two 5" swivel and two 5" rigid casters. All benches are 36" overall in height with a 600 lbs. capacity. Features 1/2" particle board decking. Steel Color: Powder coated gray.



W x D x H	Model Number	Price Each	Model Number	Price Each	Model Number	Price Each
	2 Shelf Workbench		3 Shelf Workbench		Extra Shelves	
36" x 24" x 36"	BC2-3624-30W	201.05	BC3-3624-30W	225.76	BX1-3624-W	24.71
48" x 12" x 36"	BC2-4812-30W	180.09	BC3-4812-30W	202.45	BX1-4812-W	22.37
48" x 18" x 36"	BC2-4818-30W	198.08	BC3-4818-30W	224.43	BX1-4818-W	26.34
48" x 24" x 36"	BC2-4824-30W	215.36	BC3-4824-30W	245.66	BX1-4824-W	30.32
48" x 36" x 36"	BC2-4836-30W	255.44	BC3-4836-30W	294.15	BX1-4836-W	38.70
60" x 24" x 36"	BC2-6024-30W	241.12	BC3-6024-30W	278.82	BX1-6024-W	37.74
60" x 30" x 36"	BC2-6030-30W	255.69	BC3-6030-30W	298.25	BX1-6030-W	42.59
60" x 36" x 36"	BC2-6036-30W	275.17	BC3-6036-30W	322.56	BX1-6036-W	47.40

Mobile Shelf Carts

These highly functional mobile shelf carts are built to last. Heavy duty steel construction insures years of dependable service. Available in a variety of sizes to fit your specific needs. Shelves can be installed with either lip down for tray style or lip up for deck style. These carts include four heavy duty 5" or 6" casters (two swivel and two rigid). Unit height 66". Steel color: Powder coated gray. Cart capacity with 5" casters: 600 lbs. Cart capacity with 6" casters: 1200 lbs. Features 1/2" particle board decking.



Heavy duty double rivets & advanced boltless design



W x D x H	3 Shelf Workbench		3 Shelf Workbench		4 Shelf Workbench		4 Shelf Workbench		Extra Shelves	
	Model Number	Price Each	Model Number	Price Each	Model Number	Price Each	Model Number	Price Each	Model Number	Price Each
	with 5" Casters		with 6" Casters		with 5" Casters		with 6" Casters		Extra Shelves	
36" x 24" x 66"	BC3-3624-60W	241.09	BCH3-3624-60W	272.59	BC4-3624-60W	265.80	BCH4-3624-60W	297.30	BX1-3624-W	24.71
48" x 12" x 66"	BC3-4812-60W	217.78	BCH3-4812-60W	249.28	BC4-4812-60W	240.15	BCH4-4812-60W	271.65	BX1-4812-W	22.37
48" x 18" x 66"	BC3-4818-60W	239.76	BCH3-4818-60W	271.26	BC4-4818-60W	266.10	BCH4-4818-60W	297.60	BX1-4818-W	26.34
48" x 24" x 66"	BC3-4824-60W	260.99	BCH3-4824-60W	292.49	BC4-4824-60W	291.29	BCH4-4824-60W	322.79	BX1-4824-W	30.32
48" x 36" x 66"	BC3-4836-60W	309.48	BCH3-4836-60W	340.98	BC4-4836-60W	348.18	BCH4-4836-60W	379.68	BX1-4836-W	38.70
60" x 24" x 66"	BC3-6024-60W	294.15	BCH3-6024-60W	325.65	BC4-6024-60W	331.84	BCH4-6024-60W	363.34	BX1-6024-W	37.74
60" x 30" x 66"	BC3-6030-60W	313.58	BCH3-6030-60W	345.08	BC4-6030-60W	356.15	BCH4-6030-60W	387.65	BX1-6030-W	42.59
60" x 36" x 66"	BC3-6036-60W	337.89	BCH3-6036-60W	369.39	BC4-6036-60W	385.28	BCH4-6036-60W	416.78	BX1-6036-W	47.40

Economy Service Carts



Heavy gauge steel makes our Economy Service Cart superior to most other bolt-together carts on the market. Trays are 3 $\frac{3}{8}$ " deep. Top tray can be reversed to provide platform top. Includes two swivel (locking) and two rigid polypropylene casters. Durable gray powder coated finish. Easy to assemble.

W x L x H	Capacity	Model Number	Price Each
16" x 30" x 32"	400	220-CSK1630	157.57

Platform Trucks with Fold-Down Handle



Versatile platform truck features a fold-down handle for easy storage. Ideal for transporting boxes and light equipment around office or warehouse. Plastic bumpers protect walls, furniture and doorways.

W x L	Capacity	Model Number	Price Each
17" x 27"	300	220-PFD1	73.37
22" x 34"	500	220-PFD2	108.76

Heavy Duty Platform Trucks

These durable platform trucks are constructed of heavy gauge steel and are all welded to provide years of dependable service. Deck platform is reinforced to give these rugged trucks incredible strength. All carts now feature a removable handle with two handle cross braces. All platform trucks include 2 swivel (at handle) and 2 rigid casters.

Plastic Service Carts

Plastic carts won't rust and are less conductive than metal service carts making them ideal for use with electronic components. Carts come with two swivel and two rigid 5" rubber caster wheels. Assembles in minutes. Cart capacity: 300 lbs



2 Shelf Cart

3 Shelf Cart

W x L	Caster Size	Truck Capacity	Model Number	Price Each
24" x 48"	5"	600	PR2448	180.83
27" x 54"	5"	600	PR2754	222.76
30" x 60"	5"	600	PR3060	229.31
36" x 72"	5"	600	PR3672	272.55
24" x 48"	6"	1,200	PS2448	214.89
30" x 60"	6"	1,200	PS3060	260.76
36" x 72"	6"	1,200	PS3672	302.69
24" x 48"	8"	1,600	PW2448	269.93
30" x 60"	8"	1,600	PW3060	314.48
36" x 72"	8"	1,600	PW3672	357.72

W x L	Shelf	Capacity	Model Number	Price Each
16" x 30"	2	300	220-CSP1630	215.25
24" x 36"	2	300	220-CSP2436	264.60
16" x 30"	3	300	MCSP1630	255.07
24" x 36"	3	300	MCSP2436	351.18



FastRak Tire Storage Shelving

FastRak unit design makes these extra heavy duty units perfect for storing today's larger tires. Recommended for tires that accommodate 16" and larger rims. 48"W , 72"W and 96"W units accommodate 6, 9 and 12 tires (estimated) per level respectively. All units are 18" deep. Units feature a newly designed upright that can be "knocked down" for easier shipment. Uprights can be shipped pre-assembled for an additional charge per upright. Optional deluxe footplates and concrete wedge anchors are available for added safety and permanent placement.

Starter Units				Add-On Units	
W x D x H	# of Levels	Model Number	Price Each	Model Number	Price Each
48" x 18" x 96"	3	K33S-4818096	219.58	K33T-4818096	164.72
48" x 18" x 120"	4	K34S-4818120	283.46	K34T-4818120	214.98
72" x 18" x 96"	3	K33S-7218096	268.97	K33T-7218096	214.13
72" x 18" x 120"	4	K34S-7218120	349.31	K34T-7218120	280.83
96" x 18" x 96"	3	K33S-9618096	318.49	K33T-9618096	263.63
96" x 18" x 120"	4	K34S-9618120	415.34	K34T-9618120	346.86

FastRak Cable Reel Racks

Based on the popular FastRak Bulk Storage Shelving, these rugged reel racks are super strong and highly versatile. Heavy duty uprights are completely welded. Beams attach quickly to uprights using popular "tear drop" design and can be adjusted in 1½" increments. Beams also feature a built-in locking clip for added safety. Free standing "Starter" units include 2 uprights, 3 beams and 3 rods (36" tall units include 2 rods). Create a row of rack by purchasing "Add-On" units. Customize your rack by purchasing additional rods (1 per level) and brackets (2 brackets are required per level). 1" diameter rods can support up to 350 lbs. per level. Unit capacity: 6,000 lbs.

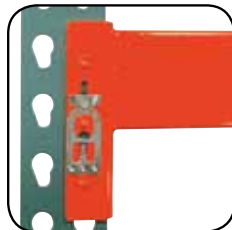

Description	Model Number	Price Each
Extra Rods		
24" Bar (1" Dia.)	215-CR01024	8.25
36" Bar (1" Dia.)	215-CR01036	12.38
48" Bar (1" Dia.)	215-CR01048	16.51
Extra Brackets		
Bar Bracket (left)	215-CRBL01	9.56
Bar Bracket (right)	215-CRBR01	9.56

Starter Units			Add-On Units	
W x D x H	Model Number	Price Each	Model Number	Price Each
24" x 18" x 36"	FRS-2418-036	138.50	FRT-2418-036	109.46
36" x 18" x 36"	FRS-3618-036	158.21	FRT-3618-036	129.18
48" x 18" x 36"	FRS-4818-036	184.23	FRT-4818-036	155.20
24" x 24" x 72"	FRS-2424-072	210.11	FRT-2424-072	158.95
36" x 24" x 72"	FRS-3624-072	233.95	FRT-3624-072	182.79
48" x 24" x 72"	FRS-4824-072	264.10	FRT-4824-072	212.94
24" x 24" x 96"	FRS-2424-096	234.99	FRT-2424-096	171.39
36" x 24" x 96"	FRS-3624-096	258.84	FRT-3624-096	195.24
48" x 24" x 96"	FRS-4824-096	288.98	FRT-4824-096	225.38
24" x 36" x 96"	FRS-2436-096	251.58	FRT-2436-096	179.69
36" x 36" x 96"	FRS-3636-096	275.43	FRT-3636-096	203.53
48" x 36" x 96"	FRS-4836-096	305.57	FRT-4836-096	233.68
24" x 24" x 120"	FRS-2424-120	257.00	FRT-2424-120	182.40
36" x 24" x 120"	FRS-3624-120	280.84	FRT-3624-120	206.24
48" x 24" x 120"	FRS-4824-120	310.99	FRT-4824-120	236.39
24" x 36" x 120"	FRS-2436-120	279.22	FRT-2436-120	193.50
36" x 36" x 120"	FRS-3636-120	303.06	FRT-3636-120	217.35
48" x 36" x 120"	FRS-4836-120	333.21	FRT-4836-120	247.50

Boltless Modular Shelving 1/2" Decking

Featuring a split-post design that allows you to economically create the storage system or workcenter you need. Unit is completely and securely packaged as a set that allows for easy shipment. Unit can be assembled as a 72" high storage unit or as two 36" high workcenters. Assembles in minutes without nuts, bolts or shelf clips. Unit features 5 shelves that come complete with 1/2" particle board, 1/2" laminated board decking, or wire mesh decking. Steel color: Gray. Unit capacity: 4,000 lbs.



Assemble as a 72"H shelving unit or a 36"H workbench. Choose either particle board, laminated board or wire mesh decking.



Size W x D x H	Shelf Cap.	Wire Mesh Decking		Particle Board Decking		Laminated Board Decking	
		Starter Unit	Price	Starter Unit	Price	Starter Unit	Price
36" x 18" x 72"	800	200-XR1505M	148.22	200-XR1505	125.38	200-XR1505L	154.99
48" x 24" x 72"	800	200-XR2505M	223.23	200-XR2505	173.88	200-XR2505L	216.93

Boltless Modular Shelving 3/4" Particle Board Decking



Featuring a split-post design that allows you to economically create the storage system or workcenter you need. Unit is completely and securely packaged as a set that allows for easy shipment. Unit can be assembled as a 72" high storage unit or as two 36" high workcenters. Assembles in minutes without nuts, bolts or shelf clips. Unit features 5 shelves that come complete with 3/4" particle board decking. Steel color: Gray. Unit capacity: 4,000 lbs.



Assemble as a 72"H shelving unit or a 36"H workbench. Unit comes with 3/4" particle board decking.

Size W x D x H	Shelf Cap.	Particle Board Decking	
		Starter Unit	Price
3/4" Decking			
36" x 12" x 72"	800	200-XR1305HD	78.66
48" x 12" x 72"	800	200-XR2305HD	98.35

SEE PAGES

- » Boltless Shelving 2-13
- » Pallet Rack 14-17
- » FastRak™ Shelving 18-25
- » Archive Shelving 26-27
- » Cantilever Rack 28-29
- » Wire Shelving 30-34
- » Workbenches 35-37
- » Bins & Bin Units 38-43
- » Carts & Trucks 44-45
- » Tire & Reel Rack 46
- » Packaged Shelving 47

 **Material Handling USA**
800-326-4403
<https://www.mh-usa.com/>
Sales@MaterialHandling-USA.com

Catalog Version: 2015A

Pallet Rack
Pages 14-17



Heavy Duty Cantilever Rack
Page 29



FastRak™ Cable Reel Rack
Page 46



Bin Storage Units
Pages 38-43



Pre-Packaged Shelving
Page 47



Carts & Trucks
Pages 44-45

