

Rivet-Span®



 **Material Handling USA**

**Call Now for a Free
Quote or Site Visit!**

222 S. Main St. 5th Floor
Salt Lake City, UT 84101
800-326-4403
<https://www.mh-usa.com/>

SUPERSTORE

MH-USA

Material Handling USA

 **Borroughs**
CORPORATION

Why Rivet-Span®?



RIVET-SPAN IS AN ECONOMICAL AND VERSATILE hand-load storage product that is incredibly easy to assemble, yet strong. It starts with a simple, economical design. A unit consists of posts, horizontal beams and wood decking. A variety of beams are available to accommodate a wide range of loads...and in spans and depths wider and greater than conventional shelving. Beams have high strength shoulder rivets that engage double keyhole post slots to form a strong and rigid unit. All components are universal (no lefts or rights, fronts or backs). Without the hassle of nuts, bolts, clips or cross braces, Rivet-Span installation is quick and easy.

ECONOMICAL

- Low initial investment reduces shelving costs
- Quick labor saving installation reduces set-up costs
- Sizes to eliminate costly decking material cutting charges

STRONG

- Steel frame construction extends shelving life
- Rigid boltless connection between posts and beams
- Secure double key hole and shoulder rivet connections

SIMPLE ASSEMBLY

- All pieces universal
 - No lefts or rights
 - No fronts or backs
 - No tops or bottoms
- Requires no cross or sway braces

FLEXIBLE

- Allows access from any or all four sides
- Variety of beams to accommodate a wide range of loads
- Spans up to 8' to optimize storage

Primary Components

BULK STORAGE UNIT

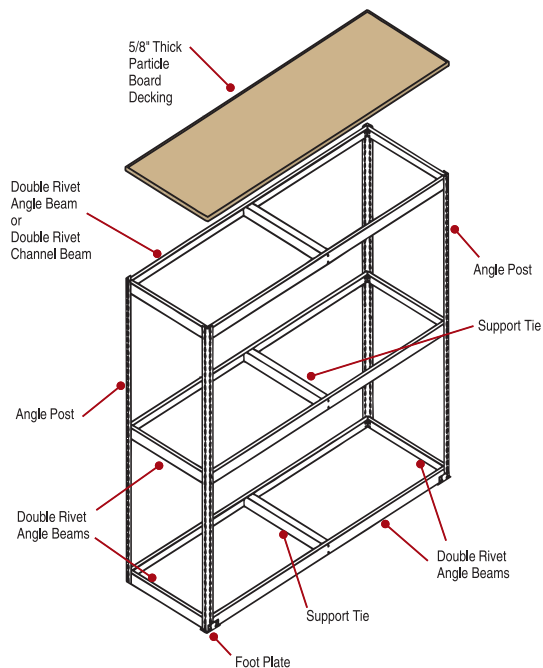

SHELVING UNIT

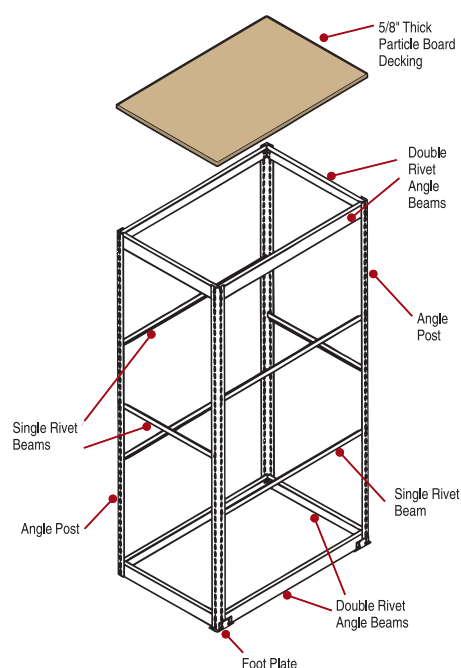

Rivet-Span® Types

BULK STORAGE UNITS are ideally suited to virtually any type of hand-loaded material. It is designed for greater cube capacity than shelving and lower price than rack. Rivet-Span can be used to make bulk storage racks for storing a broad range of hand-loaded heavy materials, bulky parts or hard-to-store items.

- Designed for spans of 48" to 96" wide
- Choice of beam capacity to meet your storage requirements
- Uses double rivet angle, channel or Z beams
- Beam levels adjust on 1-1/2" centers
- T Post adder units further reduce material investment and installation time



SHELF UNITS can be used as quick, low-cost, steel wood shelving. Single rivet and double rivet low profile beams provide maximum space between shelf levels. Plus, Rivet-Span is ideal for double entry shelving units. It can be accessed from all four sides because no cross braces or face braces are required for stability.

- Designed for units up to 48" wide
- Uses single rivet or double rivet low profile beams on intermediate levels
- Uses full "perimeter" double rivet angle beams at the top and bottom levels for rigidity
- Shelf levels adjust on 1-1/2" centers
- T Posts provide additional savings on runs of shelving



SPECIALTY UNITS are limited only by the imagination of the individual. The most obvious use is archival records storage. However, specialty units are perfect for many hard-to-store items and can include the following:

- Counter high units
- Tire racks
- Workbenches
- Packing or receiving tables
- Garment hang rod units



Beam Profiles



Single Rivet Beam
Standard duty shelving



Double Rivet Low Profile Beam
Heavy duty shelving



Double Rivet Z Beam 12" to 60"
Heavy duty shelving



Double Rivet Z Beam 69" and 72"
Standard duty bulk storage



Double Rivet Angle Beam
Standard duty bulk storage



Double Rivet Channel Beam
Heavy duty bulk storage



Tire Beam
Tires and Wheels
Standard duty

Units / Posts Overhead View

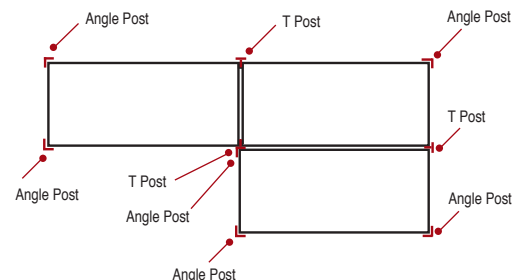

Rivet-Span® Bulk Storage Units

table 1



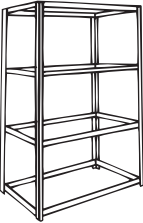
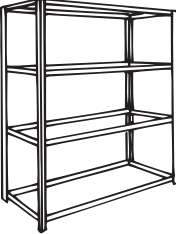
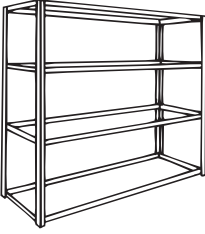
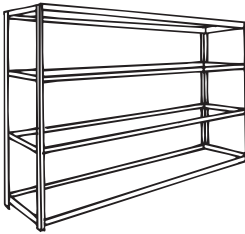



Simple Economical Storage that is strong for today's wide variety of hand-loaded bulky, heavy or hard-to-store items. Rivet-Span® offers a complete range of sizes with spans and depths wider and greater than conventional shelving.

		7' HIGH WITH 4 BEAM LEVELS					
		Starter Unit Catalog No	Adder Unit Catalog No	Unit Depth	Capacity Per Beam Level (lbs.)	Beam Type	Extra Beam Level Catalog No
48" Wide		B4818DR47	A4818DR47	18"	730	Angle	BL4818DR
		B4824DR47	A4824DR47	24"	730	Angle	BL4824DR
		B4830DR47	A4830DR47	30"	730	Angle	BL4830DR
		B4836DR47	A4836DR47	36"	730	Angle	BL4836DR
		B4848DR47	A4848DR47	48"	730	Angle	BL4848DR
60" Wide		B6018DR47	A6018DR47	18"	680	Angle	BL6018DR
		B6018DH47	A6018DH47	18"	1300	Angle	BL6018DH
		B6018CH47	A6018CH47	18"	2250	Channel	BL6018CH
		B6024DR47	A6024DR47	24"	680	Angle	BL6024DR
		B6024DH47	A6024DH47	24"	1300	Angle	BL6024DH
		B6024CH47	A6024CH47	24"	2250	Channel	BL6024CH
		B6030DR47	A6030DR47	30"	680	Angle	BL6030DR
		B6030DH47	A6030DH47	30"	1300	Angle	BL6030DH
		B6030CH47	A6030CH47	30"	2250	Channel	BL6030CH
		B6036DR47	A6036DR47	36"	680	Angle	BL6036DR
		B6036DH47	A6036DH47	36"	1300	Angle	BL6036DH
		B6036CH47	A6036CH47	36"	2250	Channel	BL6036CH
		B6048DR47	A6048DR47	48"	680	Angle	BL6048DR
B6048DH47	A6048DH47	48"	1300	Angle	BL6048DH		
B6048CH47	A6048CH47	48"	2250	Channel	BL6048CH		
72" Wide		B7218DR47	A7218DR47	18"	450	Angle	BL7218DR
		B7218DH47	A7218DH47	18"	1050	Angle	BL7218DH
		B7218CH47	A7218CH47	18"	1700	Channel	BL7218CH
		B7224DR47	A7224DR47	24"	450	Angle	BL7224DR
		B7224DH47	A7224DH47	24"	1050	Angle	BL7224DH
		B7224CH47	A7224CH47	24"	1700	Channel	BL7224CH
		B7230DR47	A7230DR47	30"	450	Angle	BL7230DR
		B7230DH47	A7230DH47	30"	1050	Angle	BL7230DH
		B7230CH47	A7230CH47	30"	1700	Channel	BL7230CH
		B7236DR47	A7236DR47	36"	450	Angle	BL7236DR
		B7236DH47	A7236DH47	36"	1050	Angle	BL7236DH
		B7236CH47	A7236CH47	36"	1700	Channel	BL7236CH
		B7248DR47	A7248DR47	48"	450	Angle	BL7248DR
B7248DH47	A7248DH47	48"	1050	Angle	BL7248DH		
B7248CH47	A7248CH47	48"	1700	Channel	BL7248CH		
96" Wide		B9618DH47	A9618DH47	18"	650	Angle	BL9618DH
		B9618CH47	A9618CH47	18"	1300	Channel	BL9618CH
		B9624DH47	A9624DH47	24"	650	Angle	BL9624DH
		B9624CH47	A9624CH47	24"	1300	Channel	BL9624CH
		B9630DH47	A9630DH47	30"	650	Angle	BL9630DH
		B9630CH47	A9630CH47	30"	1300	Channel	BL9630CH
		B9636DH47	A9636DH47	36"	650	Angle	BL9636DH
		B9636CH47	A9636CH47	36"	1300	Channel	BL9636CH
		B9648DH47	A9648DH47	48"	650	Angle	BL9648DH
B9648CH47	A9648CH47	48"	1300	Channel	BL9648CH		

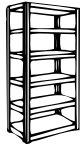
Rivet-Span® Shelf Units

table 2

Quick low-cost shelving with low profile steel supports. Rivet-Span's single rivet and double rivet low profile beams provide optimum vertical shelf openings without the hassle of nuts, bolts, clips or cross braces.

		SINGLE RIVET SHELF UNITS • 7' HIGH WITH 6 BEAM LEVELS				
		Starter Unit Catalog No	Adder Unit Catalog No	Unit Depth	Capacity Per Beam Level (lbs.)	Extra Shelf Level Catalog No
36" Wide		B3612SR67	A3612SR67	12"	350	BL3612SR
		B3618SR67	A3618SR67	18"	350	BL3618SR
		B3624SR67	A3624SR67	24"	350	BL3624SR
		B3636SR67	A3636SR67	36"	350	BL3636SR
42" Wide		B4212SR67	A4212SR67	12"	260	BL4212SR
		B4218SR67	A4218SR67	18"	260	BL4218SR
		B4224SR67	A4224SR67	24"	260	BL4224SR
		B4236SR67	A4236SR67	36"	260	BL4236SR
48" Wide		B4812SR67	A4812SR67	12"	240	BL4812SR
		B4818SR67	A4818SR67	18"	240	BL4812SR
		B4824SR67	A4824SR67	24"	240	BL4824SR
		B4836SR67	A4836SR67	36"	240	BL4836SR
		DOUBLE RIVET LOW PROFILE SHELF UNITS • 7' HIGH WITH 7 BEAM LEVELS				
36" Wide		B3612LP77	A3612LP77	12"	450	BL3612LP
		B3618LP77	A3618LP77	18"	450	BL3618LP
		B3624LP77	A3624LP77	24"	450	BL3624LP
		B3636LP77	A3636LP77	36"	450	BL3636LP
42" Wide		B4212LP77	A4212LP77	12"	430	BL4212LP
		B4218LP77	A4218LP77	18"	430	BL4218LP
		B4224LP77	A4224LP77	24"	430	BL4224LP
		B4236LP77	A4236LP77	36"	430	BL4236LP
48" Wide		B4812LP77	A4812LP77	12"	400	BL4812LP
		B4818LP77	A4818SR67	18"	400	BL4818LP
		B4824LP77	A4824LP77	24"	400	BL4824LP
		B4836LP77	A4836LP77	36"	400	BL4836LP

NOTES:

tables 1 and 2:

- Starter unit has four angle posts; Adder unit has two T posts.
- Capacities are for steel beams only with evenly distributed loads and do not reflect the capacity of the decking material.
- All units include metal frame only. **Decking material must be ordered separately.**

table 1:

- Units with channel beams have angle beams with support ties located directly at the floor level.

DR = Double Rivet Angle Beams



DH = Double Rivet Angle Beams with Support Tie

CH = Double Rivet Channel Beams with Support Tie

table 2:

- All units include double rivet angle beams, left-to-right and front-to-back, at the top and bottom beam levels.
- Shelf units 24" deep or less include only two intermediate front-to-back single rivet beams. Units 30" or deeper include front-to-back single rivet beams at every intermediate beam level.
- Extra shelf levels 24" deep or less include left-to-right beams only. Extra shelf levels 30" deep or more also include front-to-back single rivet beams.







Z BEAM BULK STORAGE UNITS • 7' HIGH WITH 4 BEAM LEVELS

	Starter Unit Catalog No	Adder Unit Catalog No	Unit Depth	Capacity Per Beam Level (lbs.)	Extra Beam Level Catalog No
48" Wide 	B4818ZB47	A4818ZB47	18"	1300	BL4818ZB
	B4824ZB47	A4824ZB47	24"	1300	BL4824ZB
	B4830ZB47	A4830ZB47	30"	1300	BL4830ZB
	B4836ZB47	A4836ZB47	36"	1300	BL4836ZB
	B4848ZB47	A4848ZB47	48"	1300	BL4848ZB
60" Wide 	B6018ZB47	A6018ZB47	18"	800	BL6018ZB
	B6024ZB47	A6024ZB47	24"	800	BL6024ZB
	B6030ZB47	A6030ZB47	30"	800	BL6030ZB
	B6036ZB47	A6036ZB47	36"	800	BL6036ZB
	B6048ZB47	A6048ZB47	48"	800	BL6048ZB
72" Wide 	B7218ZB47	A7218ZB47	18"	600	BL7218ZB
	B7224ZB47	A7224ZB47	24"	600	BL7224ZB
	B7230ZB47	A7230ZB47	30"	600	BL7230ZB
	B7236ZB47	A7236ZB47	36"	600	BL7236ZB
	B7248ZB47	A7248ZB47	48"	600	BL7248ZB

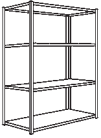
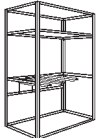
NOTES:

- Starter unit has four angle posts; Adder unit has two T posts.
- All units include metal frame only. **Decking material must be ordered separately.**
- Capacities are for steel beams only with evenly distributed loads and do not reflect the capacity of the decking material.

AUTOMOTIVE STORAGE UNITS

	Unit Catalog No	Unit Width	Unit Depth	Unit Height	Application
	BSR1-7236	72"	36"	8'	Bulky Parts
	BSR1+7236	72"	36"	8'	Bulky Parts
	BSR2-7236	72"	36"	8'	Bumpers & Bars
	BSR2+7236	72"	36"	8'	Bumpers & Bars
	BSR3-7236	72"	36"	8'	Fenders & Doors
	BSR3+7236	72"	36"	8'	Fenders & Doors
	BSR4-7236	72"	36"	8'	Two-Tier Fenders
	BSR4+7236	72"	36"	8'	Two-Tier Fenders
	BSR5-9636	96"	36"	8'	Hanging Parts
	BSR5+9636	96"	36"	8'	Hanging Parts
	BSR6-4848	48"	48"	8'	Hoods
	BSR6+4848	48"	48"	8'	Hoods
	BSR7-4860	48"	60"	8'	Deep Hoods
	BSR7+4860	48"	60"	8'	Deep Hoods
	BSR8-7236	72"	36"	8'	Top Tier Fenders
	BSR8+7236	72"	36"	8'	Top Tier Fenders
	BSR9-9636	96"	36"	8'	Quarter Panels
	BSR9+9636	96"	36"	8'	Quarter Panels
					

NOTES:

(-) means basic units - no specialty components; (+) means complete units.

Rivet-Span® Specialty Units

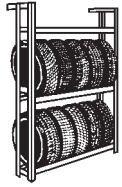

Single Entry



Double Entry

TIRE RACKS

Starter Unit Catalog No	Adder Unit Catalog No	Unit Width	Unit Depth	Unit Height	Beam Levels	Tire Capacity
B60SETB37	A60SETB37	60"	12"	7'	3	24
B60SETB40	A60SETB40	60"	12"	10'	4	32
B60SETB52	A60SETB52	60"	12"	12'	5	40
B60DETB37	A60DETB37	60"	42"	7'	3	48
B60DETB40	A60DETB40	60"	42"	10'	4	64
B60DETB52	A60DETB52	60"	42"	12'	5	80

NOTES:

Tire capacities are approximate and are based upon average automobile tire.



The Rivet-Span Tire rack has a specially designed angled tire beam to "nest" the tires and wheels.



Retail establishments use Rivet-Span for back room garment hang rod units.

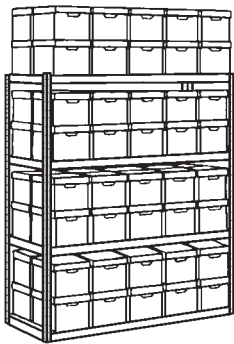

B6930DH47

BULK STORAGE TYPE FOR USE WITH DECKING

Starter Unit Catalog No	Adder Unit Catalog No	Unit Width	Unit Depth	Unit Height	Beam Levels	Type of Box	Number of Boxes
<i>For 1 Cubic Foot Boxes</i>							
B6915DR36	A6915DR36	69"	15"	6'	3	1 cu. ft.	30
B6915DR47	A6915DR47	69"	15"	7'	4	1 cu. ft.	40
B6915DR59	A6915DR59	69"	15"	9'	5	1 cu. ft.	50
<i>Boxes stored 5 across x 2 High x 1 Deep • All beam levels utilized for storage</i>							
B6930DH36	A6930DH36	69"	30"	6'	3	1 cu. ft.	60
B6930DH47	A6930DH47	69"	30"	7'	4	1 cu. ft.	80
B6930DH59	A6930DH59	69"	30"	9'	5	1 cu. ft.	100
<i>Boxes stored 5 across x 2 High x 2 Deep • All beam levels utilized for storage</i>							
B6948CH36	A6948CH36	69"	48"	6'	3	1 cu. ft.	90
B6948CH47	A6948CH47	69"	48"	7'	4	1 cu. ft.	120
B6948CH59	A6948CH59	69"	48"	9'	5	1 cu. ft.	150
<i>Boxes stored 5 across x 2 High x 3 Deep • All beam levels utilized for storage</i>							
<i>For 1.5 Cubic Foot Boxes</i>							
B6924DR36	A6924DR36	69"	24"	6'	3	1.5 cu. ft.	30
B6924DR47	A6924DR47	69"	24"	7'	4	1.5 cu. ft.	40
B6924DR59	A6924DR59	69"	24"	9'	5	1.5 cu. ft.	50
<i>Boxes stored 5 across x 2 High x 1 Deep • All beam levels utilized for storage</i>							
B6948CH36	A6948CH36	69"	48"	6'	3	1.5 cu. ft.	60
B6948CH47	A6948CH47	69"	48"	7'	4	1.5 cu. ft.	80
B6948CH59	A6948CH59	69"	48"	9'	5	1.5 cu. ft.	100
<i>Boxes stored 5 across x 2 High x 2 Deep • All beam levels utilized for storage</i>							

Includes
Record Storage Support Angles

No Decking Required

BULK STORAGE TYPE FOR USE WITHOUT DECKING

<i>For 1 Cubic Foot Boxes</i>							
B6915PR36	A6915PR36	69"	15"	6'	3	1 cu. ft.	30
B6915PR47	A6915PR47	69"	15"	7'	4	1 cu. ft.	40
<i>Boxes stored 5 across x 2 High x 1 Deep • All beam levels utilized for storage</i>							
B6930PH36	A6930PH36	69"	30"	6'	3	1 cu. ft.	60
B6930PH47	A6930PH47	69"	30"	7'	4	1 cu. ft.	80
<i>Boxes stored 5 across x 2 High x 2 Deep • All beam levels utilized for storage</i>							

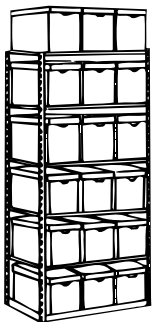

B4215SR66

SINGLE RIVET SHELF TYPE FOR USE WITH DECKING

<i>For 1 Cubic Foot Boxes</i>							
B4215SR66	A4215SR66	42"	15"	6'	6	1 cu. ft.	18
B4215SR77	A4215SR77	42"	15"	7'	7	1 cu. ft.	21
B4215SR88	A4215SR88	42"	15"	8'	8	1 cu. ft.	24
<i>Boxes stored 3 across x 1 High x 1 Deep • All beam levels utilized for storage</i>							
<i>For 1.5 Cubic Foot Boxes</i>							
B4224SR66	A4224SR66	42"	24"	6'	6	1.5 cu. ft.	18
B4224SR77	A4224SR77	42"	24"	7'	7	1.5 cu. ft.	21
B4224SR88	A4224SR88	42"	24"	8'	8	1.5 cu. ft.	24
<i>Boxes stored 3 across x 1 High x 1 Deep • All beam levels utilized for storage</i>							

NOTES:

- Record storage boxes not included. All units include metal framing only.
- Decking material must be ordered separately.

Record Storage Box Information:

1 cu. ft. size = 12-7/8" w x 15-5/8" d x 10-1/2" h
1.5 cu. ft. size = 12-5/8" w x 24" d x 10-1/4" h

Components and Accessories

ANGLE POST

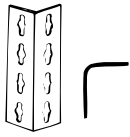

Standard duty upright post. Supplied with starter units. Use on freestanding units and row ends of units or runs of units. 1.57" x 1.57"; 14 gauge. Punched on 1-1/2" centers

Catalog No.	Size	Catalog No.	Size
10061-000	6'0"	10061-003	9'0"
10061-001	7'0"	10061-004	10'0"
10061-002	8'0"	10061-006	12'0"

HEAVY-DUTY ANGLE POST

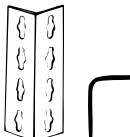

Designed for maximum load capacity and stability. 1-7/8" x 1-7/8"; 14 gauge. Punched on 1-1/2" centers.

Catalog No.	Size	Catalog No.	Size
10060-000	6'0"	10060-006	12'0"
10060-001	7'0"	10060-008	14'0"
10060-002	8'0"	10060-009	15'0"
10060-003	9'0"	10060-010	16'0"
10060-004	10'0"		

T POST

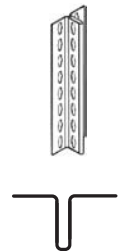

Common post between adjoining units to create economical starter and adder units. Supplied with adder units. Use as shared intermediate post between units on runs of units and also on row end of back-to-back units. 3.34" x 1.57"; 14 gauge. Punched on 1-1/2" centers.

Catalog No.	Size	Catalog No.	Size
10132-000	6'0"	10132-003	9'0"
10132-001	7'0"	10132-004	10'0"
10132-002	8'0"	10132-006	12'0"

FOOT PLATE

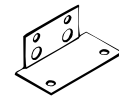

Used for weight distribution and securing posts to the floor. Designed for single (row end) and double (intermediate) posts. Use with either standard or heavy-duty angle, or T posts. 4" x 2"; 14 gauge.

Catalog No.
10103-000

TIE PLATE - ANGLE POST

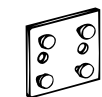

Connects posts of adjacent angle post units to insure structural stability and alignment. 4" x 2"; 14 gauge.

Catalog No.
10066-000

POST SPLICER - ANGLE POST



Used to extend the height of angle posts or heavy-duty angle posts. 13 gauge.

Catalog No.
10065-000

POST SPLICER - T POST

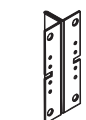

Used to extend the height of T Posts. 14 gauge.

Catalog No.
10145-000

SINGLE RIVET BEAM

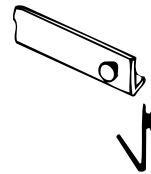

Left-to-right and front-to-back support for shelf decking. 1" high; 14 gauge.

Catalog No.	Size	Catalog No.	Size
10063-000	12"	10063-004	30"
10063-001	15"	10063-005	36"
10063-002	18"	10063-006	42"
10063-003	24"	10063-007	48"

DOUBLE RIVET LOW PROFILE BEAM

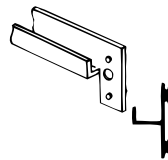

Heavier duty left-to-right support shelf decking. 1-1/4" high; 14 gauge.

Catalog No.	Size	Catalog No.	Size
16330-091	36"	16331-011	48"
16331-001	42"		

DOUBLE RIVET Z BEAM

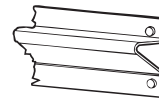

Reduced profile left-to-right and front-to-back support recesses decking to provide additional vertical storage space and protect decking edges. 2-1/4" high; 14 gauge.

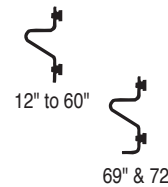

Catalog No.	Size	Catalog No.	Size
10142-000	12"	10142-005	36"
10142-001	15"	10142-006	42"
10142-002	18"	10142-007	48"
10142-003	24"	10142-008	60"
10142-004	30"	10144-009	69"
10142-012	32"	10144-010	72"

Z TIE



Used with Z Beam to support decking material.

Catalog No.	Size	Catalog No.	Size
10110-003	24"	10110-005	36"
10110-004	30"	10110-006	42"
10110-012	32"	10110-007	48"

DOUBLE RIVET ANGLE BEAM

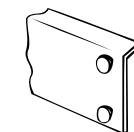

Standard left-to-right and front-to-back support for bulk storage decking and top and bottom level shelf decking. 2-5/8" x 7/8"; 14 gauge.

Catalog No.	Size	Catalog No.	Size
10068-000	12"	10068-007	48"
10068-001	15"	10068-008	60"
10068-002	18"	10068-009	69"
10068-003	24"	10097-009*	69"
10068-004	30"	10068-010	72"
10068-012	32"	10068-013	84"
10068-005	36"	10068-011	96"
10068-006	42"		

* Punched to accept Record Storage Support Angle.

DOUBLE RIVET CHANNEL BEAM

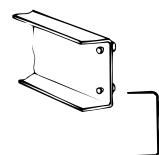

Higher capacity left-to-right support for bulk storage decking. 3" x 7/8"; 14 gauge. Channel beams cannot be located directly at floor level due to their longer face. For a beam level directly at floor level, use angle beams with support ties.

Catalog No.	Size	Catalog No.	Size
10070-007	48"	10070-010	72"
10070-008	60"	10070-013	84"
10070-009	69"	10070-011	96"
10098-009*	69"		

* Punched to accept Record Storage Support Angle.

Components and Accessories

SUPPORT TIE

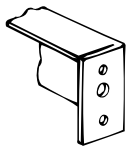

Adds support to decking material and increases capacity of double rivet angle and channel beams by limiting rotation. 2-1/2" high; 14 gauge.

Catalog No.	Size	Catalog No.	Size
10072-000	12"	10072-004	30"
10072-001	15"	10072-012	32"
10072-002	18"	10072-005	36"
10072-003	24"	10072-006	42"
		10072-007	48"

TIRE BEAM

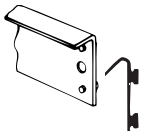

Left-to-right support for tires and wheels. 2-23/32" high; 14 gauge.

Catalog No.	Size	Catalog No.	Size
10077-005	36"	10077-008	60"
10077-007	48"		

AISLE TIE

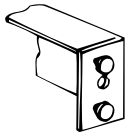

Ties units together across aisles to maintain a constant aisle and stabilize units exceeding a height-to-depth ratio of 4. Not designed to support upper level walkways. 2-1/2" high; 14 gauge.

Catalog No.	Size	Catalog No.	Size
10073-000	30"	10073-002	42"
10073-001	36"	10073-003	48"

BACK SPACER TIE

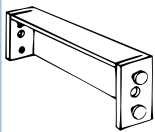

Spaces back-to-back shelving units where space is required between units such as tire storage. 2-1/2" high; 14 gauge.

Catalog No.	Size
10079-000	18"

WALL TIE

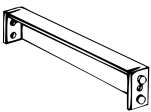

Ties rack to wall for stability where space is required between unit and wall such as wheel storage. 2-1/2" high; 14 gauge.

Catalog No.	Size
10075-000	9"

RECORD STORAGE SUPPORT ANGLE

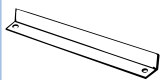

1-17/32" high; 14 gauge.

Catalog No.	Size
10099-000	15"
10099-001	30"

HANG ROD

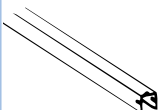

Used for hanging items within a unit. One or more may be used per level. Accepts standard clothing hangers. Support at each end by either double rivet angle or channel beams. 1-1/4" x 1-1/4"; 14 gauge.

Catalog No.	Size	Catalog No.	Size
10104-005	36"	10104-008	60"
10104-007	48"		

AISLE/FULL MAT DECKING SUPPORT

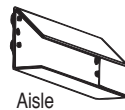

Aisle



Full Mat

Supports steel decking in catwalk systems in aisle position. Turned over, supports decking for deck over or full mat multi-level systems. 3-1/2" high; 12 gauge.

Catalog No.	Size	Catalog No.	Size
10111-005	36"	10111-008	60"
10111-006	42"	10111-009	69"
10111-007	48"	10111-010	72"

SLOTTED ANGLE CLEAT

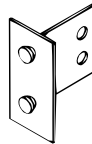

Used where slotted angle pieces must be joined to Rivet-Span, such as top tie or special grating supports. Use one left and right, facing each other, when creating cross aisle supports. 14 gauge.

Catalog No.	Size
10113-000	Right
10113-001	Left

PARTICLE BOARD DECKING

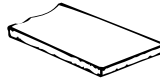

Optional bulk storage and shelf decking material. 5/8" thick.

Catalog No.	Size	Catalog No.	Size	Catalog No.	Size
10095-000	36" x 12"	10095-012	48" x 18"	10095-024	69" x 30"
10095-001	36" x 15"	10095-013	48" x 24"	10095-035	69" x 48"
10095-002	36" x 18"	10095-014	48" x 30"	10095-025	72" x 18"
10095-003	36" x 24"	10095-015	48" x 36"	10095-026	72" x 24"
10095-004	36" x 30"	10095-016	48" x 48"	10095-027	72" x 30"
10095-005	42" x 12"	10095-017	60" x 18"	10095-028	72" x 36"
10095-006	42" x 15"	10095-018	60" x 24"	10095-029	72" x 48"
10095-007	42" x 18"	10095-019	60" x 30"	10095-041	84" x 36"
10095-008	42" x 24"	10095-020	60" x 36"	10095-030	96" x 18"
10095-009	42" x 30"	10095-021	60" x 48"	10095-031	96" x 24"
10095-010	48" x 12"	10095-022	69" x 15"	10095-032	96" x 30"
10095-011	48" x 15"	10095-023	69" x 24"	10095-033	96" x 36"
				10095-034	96" x 48"

Particle board decking, 5/8" (.625) thick, is available pre-cut from Borroughs. It can also be obtained from your local building material supplier. Other types and thicknesses of decking material, such as plywood, structure wood, oriented strand board or wire decking may be desired based upon load or use.

When supplying your own decking material, cut the decking to the nominal unit size +0"-1/8" (.125). If single rivet beams or double rivet low profile beams are being used in the left-to-right position, cut the decking material 3/16" (.188) under the nominal unit depth for easier assembly. Similarly, if either of these types of beams are being used in the front-to-back position to support the decking, also cut the decking material 3/16" (.188) under the nominal unit width.

INTERMIX BEAM FAMILIES ON THE SAME BEAM LEVEL

These beam families can be intermixed without decking problems:

- Single Rivet Beams
- Double Rivet Low Profile Beams
- Double Rivet Z Beams

These beam families can be intermixed without decking problems:

- Double Rivet Angle Beams
- Double Rivet Channel Beams

The above groupings cannot be intermixed and support decking.

ACCESSORIES IN USE (END VIEW)

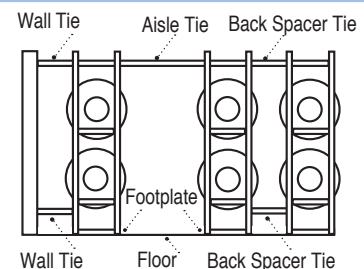

Specification Data

Rivet-Span® shelving units are made up of posts, side-to-side beams, and front-to-back beams. There are certain minimum requirements for beam use to ensure structural stability and safety. For example: all units must have a full "perimeter" of double rivet beams, meaning two side-to-side and two front-to-back, at both top and bottom of unit for stability. There are other requirements, see below.

Preconfigured Units - Include all required beams. Installation instructions (included with shipment) show how to position beams correctly.

Non-preconfigured Units - Follow these guidelines when specifying individual components:

- All units require a full perimeter of double rivet beams at top and bottom of unit.
- Single Rivet Beam (SRB) and Double Rivet Low Profile Beam (DRLPB) units 24" deep or less:
 - do not require SRB's front-to-back at each intermediate level in the unit.
 - 6'-8' high must have one SRB intermediate level front-to-back, located approximately in the middle of the unit.
 - 9'-10' high must have two SRB intermediate levels front-to-back, located to divide the height into 3 equal parts.
 - 11'-16' high must have three intermediate levels; a full perimeter of Double Rivet Beams (DRB) in the middle plus intermediate levels of front-to-back SRB's in the upper and lower halves of unit.
- Single Rivet Beam (SRB) and Double Rivet Low Profile Beam (DRLPB) units 30" deep or greater:

All units must have SRB's front-to-back at every intermediate level; units 11'-16' must have SRB's front-to-back at every intermediate level PLUS a full perimeter level of Double Rivet Beams (DRB) located approximately in the middle of the unit.

- Double Rivet Angle Beams (DRAB) and Double Rivet Channel Beams (DRCH) must have front-to-back beams at each beam level to provide decking support and ensure stability. When using DRCH from side-to-side, DRAB must be used from front-to-back.
- Tie Plates are recommended to tie adjacent Angle Post units together and to ensure structural stability. Tie plates should be used at the top and bottom of adjacent posts with additional tie plates spaced no more than 48" apart. Tie plates are not used on units with T Posts.

Calculated Post Capacities

Pounds Allowable Load Per Post

Maximum Beam Spacing In Inches	Angle Post	Heavy-Duty Angle Post
48"	1,170	1,750
42"	1,315	1,960
36"	1,460	2,180
30"	1,605	2,390
24"	1,750	2,610
18"	1,896	2,830
12"	2,040	3,050

- Maximum beam spacing is determined as the distance between left-to-right beams or front-to-back beams, whichever is greater.
- Capacities are for vertical loads where seismic forces are not a factor.

Widths

Nominal unit width = 24", 30", 32", 36", 42", 48", 60", 69", 72", 84" or 96"
Actual single unit width = nominal width + 1/2"

Depths

Nominal unit depth = 12", 15", 18", 24", 30", 32", 36", 42" or 48"
Actual single unit depth = nominal depth + 1/2"
Actual back-to-back units depth = combined actual single unit depths + 7/32"

Heights

Nominal unit height = 6', 7', 8', 10', 12', 14', 15' or 16'
Actual unit height = nominal height ± 1/32"

Length of Run

Actual length of run = sum of actual unit widths + 7/32" per adjoining unit

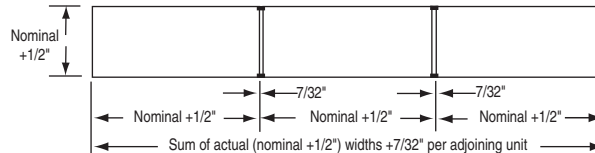

Horizontal Clear Openings

Actual clear opening between angle posts = nominal width - 2-5/8"
Actual clear opening between heavy-duty angle posts = nominal width - 3-1/4"

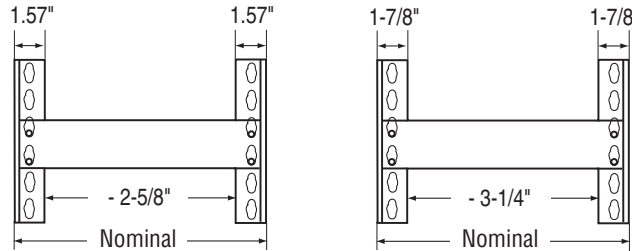

Vertical Adjustment and Clear Openings

All beams are adjustable on 1-1/2" centers

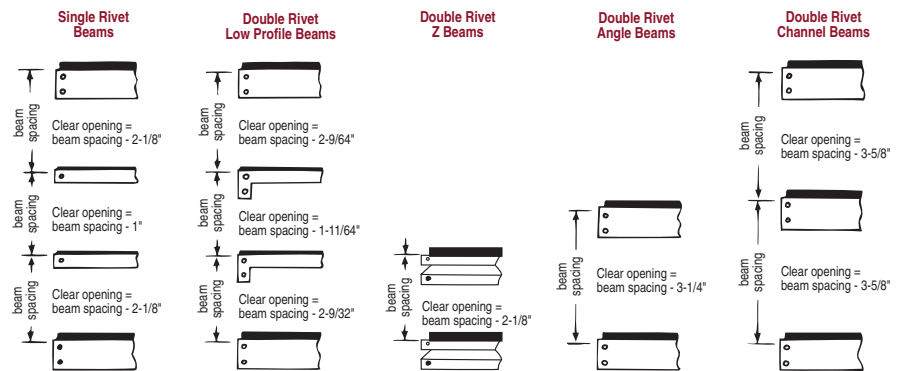

Vertical clearance calculated using 5/8" thick decking material

Beam Capacities

Maximum Uniformly Distributed Loads/Pounds Per Beam Pair

Beam Length	Single Rivet Beam	Double Rivet Low Profile Beam	Double Rivet Z Beam	Double Rivet Z Beam w/Z Tie*	Double Rivet Angle Beam	Double Rivet Angle Beam w/Support Tie	Double Rivet Channel Beam w/Support Tie
36"	350	450	1,400	-	1,400	-	-
42"	260	430	1,350	-	1,000	-	-
48"	240	400	1,300	1,600	730	1,700	-
60"	-	-	800	900	680	1,300	2,250
69"	-	-	600	900	460	1,100	1,900
72"	-	-	600	900	450	1,050	1,700
96"	-	-	-	-	240	650	1,300

- One support tie except 96" which has two support ties.
- The longest pair of beams at a given level determines the capacity for the entire level.
- Capacities are for steel beams only and do not reflect the capacity of the decking material.

(!) Wall, floor or top tie anchoring is recommended for units when the height-to-depth ratio exceeds 4.

Borroughs Standard Powder Coat Colors

Borroughs powder coat finishes are high quality, durable and inert. Industrial and Office products are available in a wide variety of standard and custom colors. For specific color policies, please refer to Borroughs Powder Coat Color Guide or contact Customer Service.

The colors depicted on this publication have been reproduced using a printing process and are only provided as a guide. The actual painted product may vary. All colors are not available on all products. Please contact your Borroughs Dealer for details.

Standard Office Storage Colors



010 Autumn Haze



065 Industrial Gray



165 Forest Gray

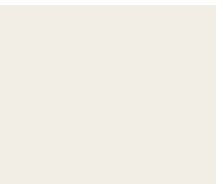

D492 Parchment

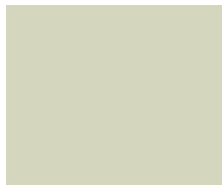

F604 Pebble

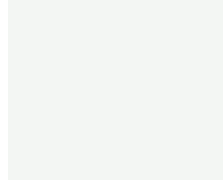

445 White



159 Eggshell



161 Mist Gray

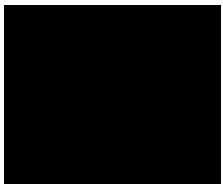

040 Black

Standard Industrial (Automotive) Colors



B504 Blue



065 Industrial Gray



C386 Red

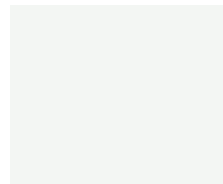

445 White

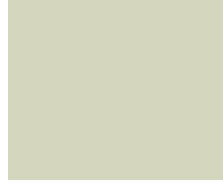

F604 Pebble

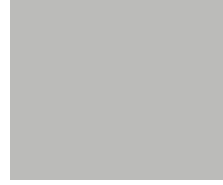

161 Mist Gray

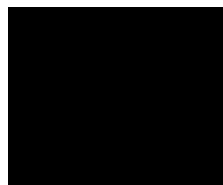

040 Black

 **Material Handling USA**
800-326-4403
<https://www.mh-usa.com/>



Authorized Dealer: Material Handling USA
222 S. Main St. 5th Floor, Salt Lake City, UT 84101
| Sales@MH-USA.com | <https://www.mh-usa.com>
/ | 800-326-4403

ISO 9001:2000 Registered
ISO 14001:2004 Registered