

# Record Master®



by Borroughs



Four-Post   Cantilever   Heavy-Duty   Case Style   Aisle-Saver® Mobile



**Call Now for a Free  
Quote or Site Visit!**

222 S. Main St. 5th Floor  
Salt Lake City, UT 84101  
800-326-4403  
<https://www.mh-usa.com/>

SUPERSTORE

MH-USA

Material Handling USA

## Record Master® Four-Post Shelving

TODAY BUSINESSES NEED TO ECONOMICALLY RETAIN and protect their file collections. Doing so in limited space, with accessibility for day-to-day use, requires specialized filing equipment.

Attractive, easy-to-assemble, space efficient Four-Post Shelving has been specifically designed for this purpose.

Open shelf filing allows folders to be clearly visible and provide easy retrieval. Units utilize vertical space to maximize file storage per square foot, while keeping files within easy reach.

Borroughs' quality construction and superior finish ensures an installation as attractive as it is efficient.

The advantages of open shelf filing, combined with Borroughs' superior durable design, make Four-Post Shelving the first choice for document filing and storage.



**Letter Size  
Capacity  
8.5 x11**

2-1/2 lbs. per  
filing inch

**Legal Size  
Capacity  
8.5 x 14**

3 lbs. per  
filing inch

## Double Entry Shelves

Double entry shelves reduce cost and maximize overall filing capacity.

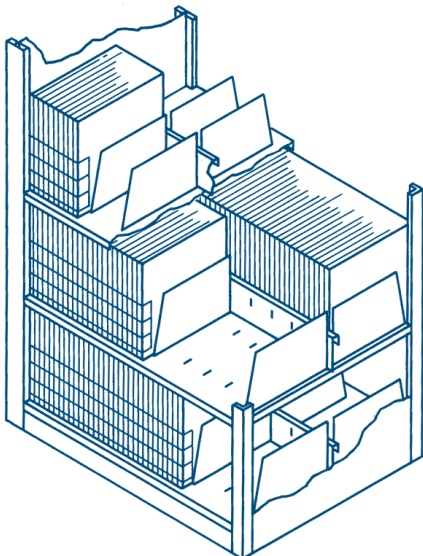

### Heights:

6-tier	64-1/4"
7-tier	76-1/4"
8-tier	88-1/4"
9-tier	97-1/4"

### Widths:

30", 36", 42" and 48"

### Depths:

<b>Single Face</b>	
Letter	12"
Legal	15"

<b>Double Face</b>	
Letter	24"
Legal	30"



## *Borroughs Four Post Shelving is an exceptional combination of strength, function and form...*

### Here's Why...

- No externally exposed holes - crisp, clean, contemporary appearance.
- No sway braces - quick, simple assembly and double-entry access.
- No exposed hardware - diminishes file damage.
- Strength and rigidity - wedge-locking, double rivet design.
- Mobile ready.
- Furniture quality finish - looks great in any office even after years of heavy use.



### High-Strength Rivets

Borroughs' high-strength shoulder design rivets carry heavy filing loads safely. Borroughs uses no tab connections.



### Low Profile Shelf

3/4" profile allows optimum shelf centers for maximum filing capacity.



### Adjustable File Divider

Color-matching file dividers interlock into slotted shelf and backstop, yet can be quickly relocated for flexibility.

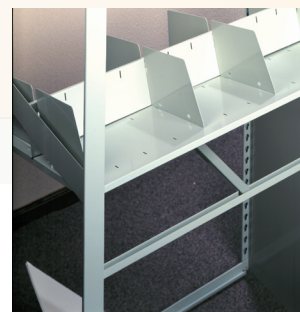

### Shelf Supports

Full-width support for increased capacity.



### Optional Full-Width Reference Shelf

30", 36", 42" and 48" widths available. Quick and convenient pull-out work surface within file areas.



### Wedge-Locking Double Rivet Shelf Support

Exceptional strength and rigidity without sway braces or nuts and bolts. Components interlock for quick and easy assembly.

## Record Master® Heavy-Duty X-Ray Shelving

THE HIGH COST OF SPACE in today's healthcare facilities puts a premium on efficient storage...And, storing X-ray folders requires shelving that is strong and durable, as well as easily accessible.

Borroughs' Heavy-Duty X-Ray Shelf Filing Units have been specifically engineered to combine strength and accessibility with compact design, for efficient use of available space.

To hold the weight of X-rays, Borroughs uses extra heavy gauge steel in manufacturing the shelves, shelf supports and reinforcements. Open shelf filing allow folders to be clearly visible for quick and easy retrieval. Units have five tiers of filing for maximum file storage per square foot, while keeping files within easy reach.

Heavy-Duty X-Ray Shelving combines the strength and efficiency needed to meet the special filing requirements of X-ray medical records.

**Heavy-Duty X-Ray Shelving is designed expressly for the special filing requirements and unique demands of medical professionals.**



**X-ray Filing  
Capacity  
15"h x 18"d**

8 lbs. per  
filing inch

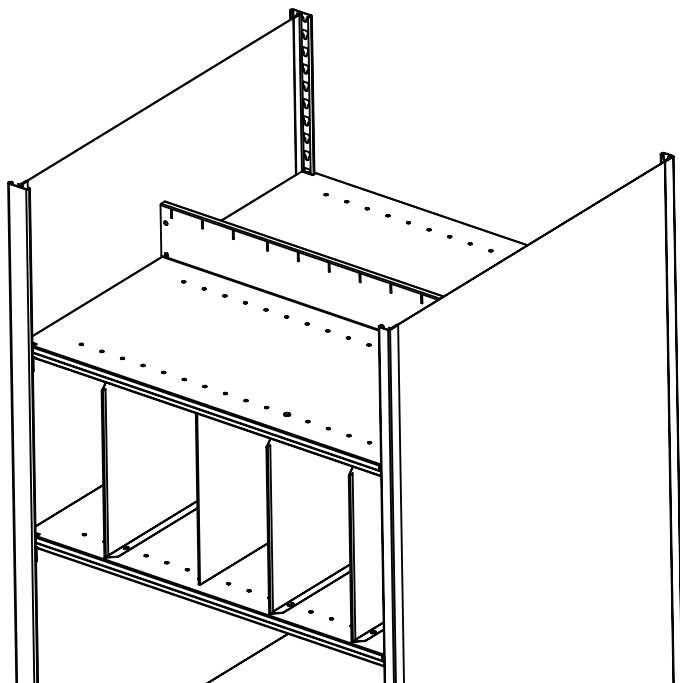

### Heights:

5-tier 83-3/4"

### Widths:

36", 42" and 48"

### Depths:

Single Face 18"

Double Face 36"

## Heavy-Duty X-Ray Shelving

Medical professionals demand an X-ray storage solution that reduces cost and raises productivity. Record Master shelving is that solution. Designed expressly for the special filing requirements of X-rays. Heavy-Duty X-Ray Shelving economically retains and protects these valuable medical records... and allows quick and easy access.

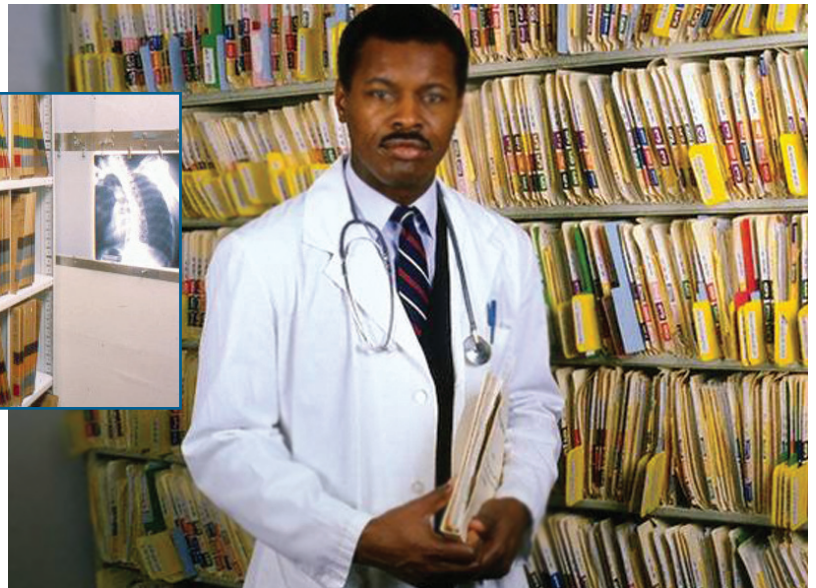

### Features and Benefits

- No externally exposed holes or hardware - crisp, clean, contemporary appearance.
- Wedge-locking double rivet design - strength and rigidity without nuts or bolts.
- Easy access to X-rays - no time consuming drawers to open and close.
- Strength and rigidity - field-proven for mobile or compact applications.
- Furniture quality finish - looks great in any office even after years of heavy use.

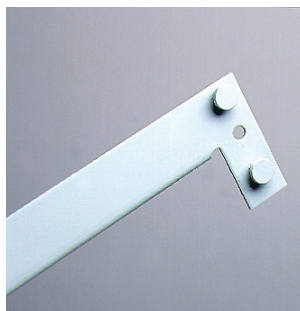

#### High-Strength Rivets

Borroughs' high-strength shoulder design rivets carry heavy filing loads safely. Borroughs uses no tab connections.

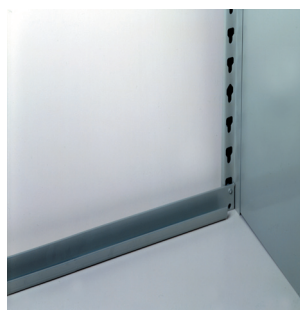

#### Single Rivet bottom Shelf Support

Maximizes X-ray capacity in minimum space. Also allows bottom flange at floor level for mobile tie-in.

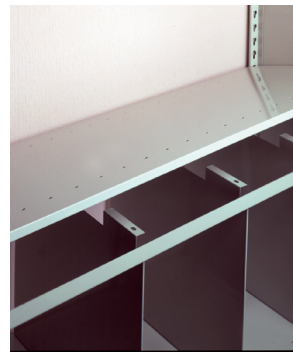

#### Full-Width Shelf Support

Heavy-duty 18 gauge steel shelf, with 11 gauge, full-width 1-1/4" thick supports, provides greater strength for X-ray storage requirements.



#### Full-Height Divider

X-Rays are heavy. A four point divider attachment accommodates the extra weight of X-ray folders.



#### Wedge-Locking Double Rivet Shelf Support

Exceptional strength and rigidity without sway braces or nuts and bolts. Components interlock for quick and easy assembly.

## Record Master® Heavy-Duty Storage Shelving

GENERAL STORAGE IN OFFICE ENVIRONMENTS, as well as healthcare, financial, commercial and institutional applications, requires strong and versatile shelving which is also attractive.

Heavy-Duty Storage Shelving meets these needs with easy-to-assemble units that ideally suit many diverse storage applications.

For maximum storage capacity, Borroughs combines heavy gauge steel shelves, shelf supports and welded uprights with rack-type construction. Smooth, unbroken lines give a finished appearance with no unsightly holes or exposed edges.

Numerous width and depth choices provide many different storage options. Plus, it's easy to install ... no nuts, bolts, clips or complicated sway braces.

Heavy-Duty Storage Shelving is strong and durable, yet looks great in any office environment.



**Heavy-Duty Storage shelving, with it's rigid construction and full-width shelf supports, will carry even the heaviest of loads safely and securely. Excellent for bulk storage applications.**

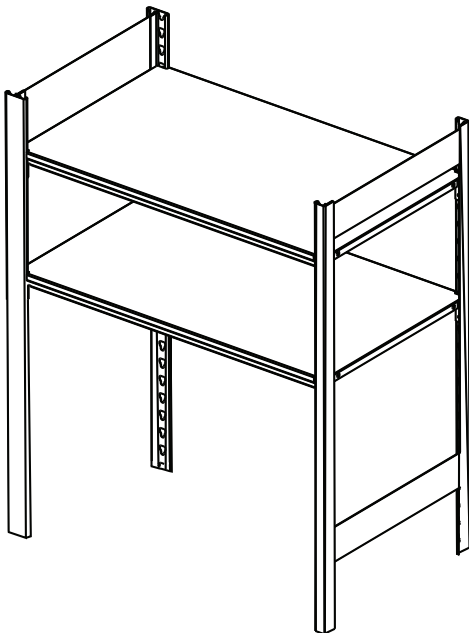

### Heights:

76-1/4", 88-1/4" and 97-1/4"

### Widths:

30", 36", 42" and 48"

### Depths:

12", 15", 18", 24", 30" and 36"

## Heavy-Duty Storage Shelving

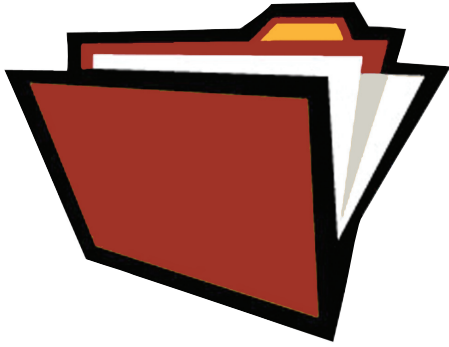

Many storage applications require a simple solution. Record Master Heavy-Duty Storage Shelving is the simple choice. It is strong and durable. It is easy to install...and is attractive. Rigid four-post construction will carry even the heaviest of loads safely. Plus, full-width shelf supports provide exceptional strength.

### Features and Benefits

- **No externally exposed holes - crisp, clean, contemporary appearance.**
- **Wedge-locking double rivet design - strength and rigidity without nuts or bolts.**
- **No sway braces - quick, simple assembly and double-entry access.**
- **Strength and rigidity - field-proven for mobile or compact applications.**
- **Furniture quality finish - looks great in any office even after years of heavy use.**



#### High-Strength Rivets

Borroughs' high-strength shoulder design rivets carry heavy filing loads safely. Borroughs uses no tab connections.



#### Heavy-Duty Shelf

18 gauge steel shelf with full-width support for increased capacity.



#### Wedge-Locking Double Rivet Shelf Support

Exceptional strength and rigidity without sway braces or nuts and bolts. Components interlock for quick and easy assembly.

Shelf Capacities							
(in pounds based on uniformly distributed static loads using 18 gauge shelves)							
Size of Shelf		With 14 Gauge Shelf Supports			With 11 Gauge Shelf Supports		
Width	Depth	Number of Shelf Reinforcements			Number of Shelf Reinforcements		
		0	2	3	0	2	3
36"	12"	675	-	-	950	-	-
36"	15"	600	625	-	675	1000	-
36"	18"	300	700	-	300	900	-
36"	24"	150	600	-	150	850	-
36"	30"	-	550	-	-	850	-
36"	36"	-	-	525	-	-	525
42"	12"	550	-	-	800	-	-
42"	15"	500	575	-	600	850	-
42"	18"	300	600	-	325	800	-
42"	24"	175	550	-	200	775	-
42"	30"	-	550	-	-	800	-
42"	36"	-	-	525	-	-	550
48"	12"	475	-	-	575	-	-
48"	15"	450	450	-	575	700	-
48"	18"	300	500	-	350	675	-
48"	24"	200	450	-	225	650	-
48"	30"	-	475	-	-	650	-
48"	36"	-	-	475	-	-	650

## Record Master® Case-Style Library Shelving

PROFESSIONAL LIBRARIES DEMAND an exceptional shelving system. It must be strong, yet incorporate a blend of beauty and flexibility. Borroughs' Case-Style Library shelving is exceptional.

Designed with a clean, contemporary look that eliminates externally exposed holes and produces a furniture-quality appearance.

Components interlock without separate fasteners for quick assembly. Plus, with no nuts or bolts, book damage is diminished. It's strong and rigid construction holding even the heaviest of book collections safely.

The Case-Style Library's crisp, clean appearance and quality finish blend beautifully with virtually any decor...And, it will continue to look great even after years of heavy use.

Whether for the medical or legal professional, for educator or librarian, or business and industry, Borroughs Case-Style Library Shelving is the exceptional shelving choice.



**Case-Style Library Shelving blends beauty and multi-functional flexibility. It solves a variety of space problems, is strong and durable and will meet your book storage requirements.**

### Double Face Unit with Optional Center Stop

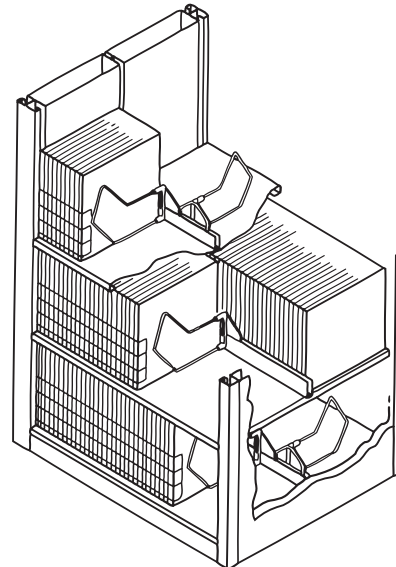
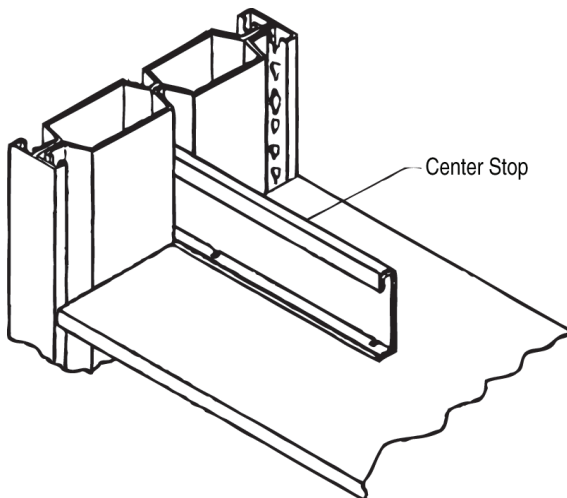



## Case-Style Shelving

### Features And Options

- No externally exposed holes - crisp, clean, contemporary appearance.
- No exposed hardware - diminishes damage to books being displayed.
- No sway braces - quick, simple assembly and double-entry access.
- Strength and rigidity - field-proven for mobile or compact applications.
- Furniture quality finish - looks great in any office even after years of heavy use.



#### Case-Style Library Shelving

Designed specifically for medical, law, professional, research or corporate libraries, Borroughs Case-Style Library Shelving is the exceptional choice.



#### Optional Full-Width Reference Shelf

30", 36", 42" and 48"

Quick and convenient pull-out work surface.

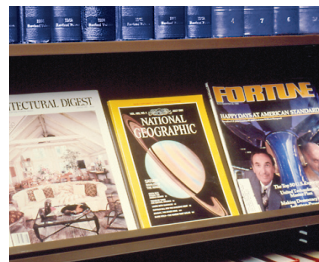

#### Hinged Periodical Shelf

11-3/4" high with a 1-7/8" deep retaining lip makes reading of magazine or other reference material titles easy.



#### Sliding Wire Divider

Adjusts quickly and easily to any position along a shelf and locks securely in place when holding books.

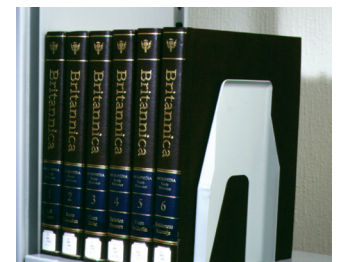

#### Findable Book Support

Cork underside prevents slipping and a formed edge prevents the support from being lost among books.

#### Heights:

40-1/4", 76-1/4" and 88-1/4"

#### Widths:

30", 36", 42" and 48"

#### Depths:

Single Face 9" and 12"

Double Face 18" and 24"



#### Wedge-Locking Double Rivet Shelf Support

Exceptional strength and rigidity without sway braces or nuts and bolts. Components interlock for quick and easy assembly.



#### Double-Wall Construction

Full-height, welded panels create furniture-like appearance and provide superior strength. Also, it prevents books from wedging behind the posts.

## Aisle-Saver® High Density Storage Systems

*Combine with Record Master to maximize your filing and storage needs*



The ultimate in high density storage systems. With the push of a button, an aisle can be created when and where needed. Smart technology and user-friendly controls provide safe, reliable performance.

### Aisle-Saver Synergy Series™

#### Electrical System

- Users can select from a wide variety of available options for safety, access, convenience and security.
- Easy to upgrade as new features become available.
- A 36" aisle opens in as little as 8 seconds.
- Also available in mechanical assist and manual models.
- Accepts loads up to 1000 lbs. per lineal foot.
- Carriage lengths available from 3' to 60'.
- Carriage widths from 15" to 60".
- All systems carry a five-year warranty.
- Complies with ADA regulations for accessibility.



#### Aisle-Saver Synergy Series™ Mechanical Assist System

### Aisle-Saver Lateral System

- Two-row and three-row deep systems available.
- Section widths: 3', 3-1/2' OR 4'.
- CARRIAGE DEPTHS: 10", 12", 13.2", 15" and 18".
- Anti-tip safety designed into the deck and track.
- Case hardened steel bearing wheels provide effortless side to side movement.
- Carriage sections are reconfigurable - as requirements change.



High density lateral storage systems are well suited for perimeter wall installations or for narrow situations where other forms of high density storage are inappropriate.

## Record Master® Accessories



**Full-Width Reference Shelf**  
Creates a quick and convenient pull-out work surface.



**Plain Shelf**  
When adjustable file dividers are not required.



**Heavy-Duty Shelf**  
Provides additional shelf load capacity for non-standard files or specialized items.

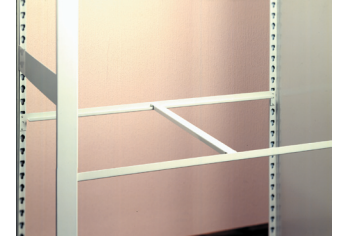

**Shelf Reinforcement**  
Added support for shelves. Available for 3/4" and 1-1/4" high shelf supports.



**Front Base**  
Protects file folders from floor maintenance equipment and produces a finished look.

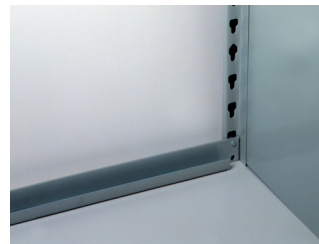

**Single Rivet Bottom Shelf Support**  
Allows bottom flange at floor level for mobile face tie-in.



**Center Stop - Unslotted**  
Divides double-entry shelf. Prevents materials from moving beyond mid-point of shelf.



**Back Panel**  
Provides neat, finished appearance.



**Decorative End Panels**  
High-density laminate, wood veneer and fabric panels further enhance aesthetics.

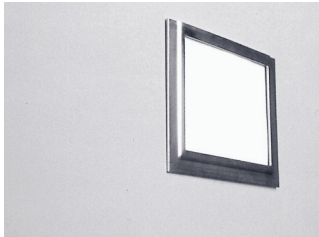

**Card Holder**  
3" x 5" zinc plated steel card holder makes identification of row contents easy.



**Range Finder**  
3" x 5" painted steel range finder makes identification of row contents easy.

# Borroughs Standard Powder Coat Colors

*Borroughs powder coat finishes are high quality, durable and inert. Record Master® products are available in a wide variety of standard and custom colors. For specific color policies, please refer to Borroughs Powder Coat Color Guide or contact Customer Service.*

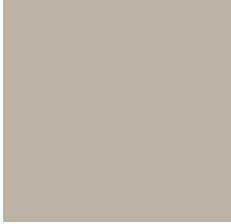

010 Autumn Haze

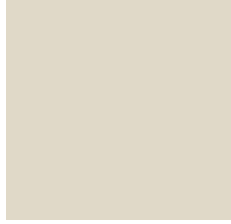

159 Eggshell

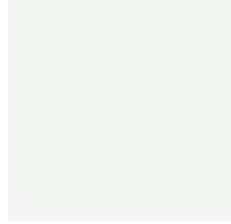

445 White

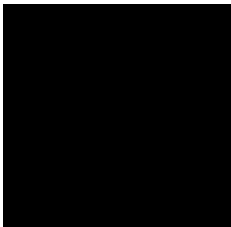

040 Black

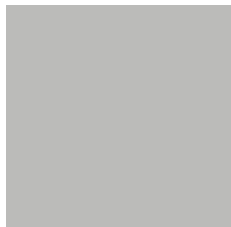

161 Mist Gray

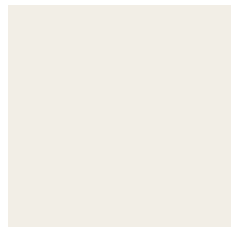

D492 Parchment



065 Industrial Gray



165 Forest Gray



F604 Pebble

*The colors depicted on this publication have been reproduced using a printing process and are only provided as a guide. The actual painted product may vary. All colors are not available on all products. Please contact your Borroughs Dealer for details.*



800-326-4403

222 S. Main St. 5th Floor, Salt Lake City, UT 84101  
| <https://www.mh-usa.com/> | 800-362-4403

**ISO 9001:2000 Registered**



**Call Now for a Free Quote or Site Visit!**  
222 S. Main St. 5th Floor  
Salt Lake City, UT 84101  
800-326-4403  
<https://www.mh-usa.com/>

Material Handling USA

SUPERSTORE

MH-USA