

storage solutions

office



Record Master® Shelving
Rivet-Span® Storage
Easy-Trak™ Mobile Systems
High Density Mobile Storage



 **Material Handling USA**

**Call Now for a Free
Quote or Site Visit!**

222 S. Main St. 5th Floor
Salt Lake City, UT 84101
800-326-4403
<https://www.mh-usa.com/>

SUPERSTORE

MH-USA

Material Handling USA



Borroughs
CORPORATION

Why Borroughs?



Everything Matches.
Everything Fits.
Everything Works.

Record Master® Four-Post Shelving

Today businesses need to economically retain and protect their file collections. Doing so in limited space, with accessibility for day-to-day use, requires specialized filing equipment.

*Attractive, easy-to-assemble, space efficient Four-Post Shelving has been specifically designed for this purpose. Open shelf filing allows folders to be clearly visible and provide easy retrieval. Units utilize vertical space to maximize file storage per square foot, while keeping files within easy reach. The advantages of open shelf filing, combined with *Borroughs'* superior durable design, make Four-Post Shelving the first choice for document filing and storage.*



Record Master Four-Post Shelving Units
Quality construction and superior finish ensures an installation as attractive as it is efficient.

- No externally exposed holes – clean, contemporary appearance.
- No sway braces – simple assembly and double-entry access.
- No exposed hardware – diminishes file damage.
- Strength and rigidity – wedge-locking, double rivet design.
- Mobile ready.
- Furniture quality finish – looks great in any office even after years of heavy use.



Adjustable File Divider
Dividers interlock into slotted shelf and backstop, yet can be quickly relocated for flexibility.

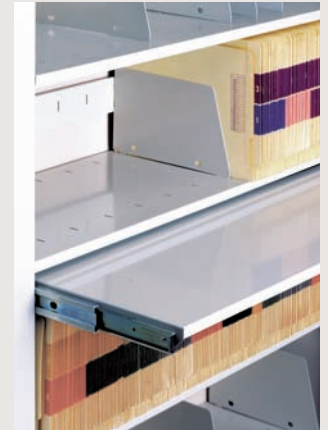

Optional Full-Width Reference Shelf
Quick and convenient pull-out work surface within file areas.



Front Base
Protects file folders from floor maintenance equipment and produces a finished look.

Unit Sizes

Widths:	30", 36", 42", 48"	
Depths:	Single-face letter 12"	Double-face letter 24"
	Single-face legal 15"	Double-face legal 30"
Heights:	6-tier: 64 1/4"	
	7-tier: 76 1/4"	
	8-tier: 88 1/4"	
	9-tier: 97 1/4"	

strong, durable and attractive

Record Master® Heavy-Duty Shelving

General storage in an office environment, as well as healthcare, financial, commercial and institutional applications requires strong and attractive versatile shelving. Heavy-Duty Storage Shelving meets these needs with easy-to-assemble units that ideally suit many diverse storage applications. For maximum storage capacity Borroughs combines heavy gauge steel shelves, shelf supports and welded uprights with rack-type construction.



Record Master Heavy-Duty Shelving is ideal for archive records, binders or any other heavy items.

Easy-To-Install

Components (wedge-locking double rivet design) interlock for quick and easy assembly. No nuts, bolts, clips or complicated sway braces. It is field-proven for mobile or compacting applications.

Furniture Quality Appearance and Finish

No unsightly holes, smooth, unbroken lines give Record Master Heavy-Duty units a crisp, clean contemporary appearance. This durable finish looks great in any office environment, even after years of heavy use.

The Simple Choice

Record Master Heavy-Duty Shelving is the simple choice. It is strong and durable, easy-to-install and also attractive. Its rigid four-post construction carries even the heaviest of loads safely. It's crisp, clean appearance and quality finish blend with virtually any decor.



Heavy-Duty Shelf
18 gauge steel shelf with full-width support.

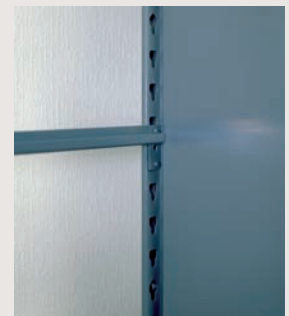

Wedge-Locking Double Rivet with Visual Index Keyholes – Exceptional strength and rigidity without sway braces or nuts and bolts.



High-Strength Rivets
designed to carry heavy loads safely.



Decorative End Panel
High density laminate, wood veneer panels further enhance aesthetics.



Shelf Reinforcement
Added support for shelves. Used for standard and single rivet shelf supports.

Unit Sizes

Widths:	30", 36", 42", 48"
Depths:	12", 15", 18", 24", 30", 36"
Heights:	64 1/4", 76 1/4", 88 1/4", 97 1/4"

blends beauty and multifunctional flexibility

Record Master® Case-Style Shelving

Whether for the medical or legal professional, for educator or librarian, or business and industry, Borroughs Case-Style Library Shelving is the exceptional shelving choice. The shelving is designed with a clean, contemporary look that eliminates externally exposed holes and produces a furniture-quality appearance.

The Case-Style Library's crisp, clean appearance and quality finish blend beautifully with virtually any decor... And, it will continue to look great even after years of heavy use.



Case-Style Bookcases

Four-Post, double-wall construction creates furniture-like appearance and provides superior strength.

Strong and Dependable

Record Master's strong and rigid four post construction will carry even the heaviest of book collections safely. Double steel shoulder rivets attach securely into uprights and full-width shelf supports provide exceptional strength and rigidity.

Quality Appearance and Finish

No unsightly holes, smooth, unbroken lines give Record Master Case-Style Library units a crisp, clean contemporary appearance. This furniture-quality finish looks great in any office environment.

Shelves

Case-style shelves formed of 18 gauge cold rolled steel with 5/8" flanges on all sides. Shelves are adjustable on 1 1/2" centers. Shelf capacity is 3 to 3.5 pounds per inch, which is evenly distributed.



Sliding Wire Divider
Slides easily along shelf and locks securely in place when holding books.



Optional Full-Width Reference Shelf
Quick and convenient pull-out work surface.



Wedge-Locking Double Rivet Shelf Support
No sway braces, nuts or bolts – components interlock for quick and easy assembly.



Double-Wall Construction
Prevents books from wedging behind the posts.

Unit Sizes

Width:	36", 42", 48"		
Depth:	Single Face	Double Face	
	9" 12"	18" 24"	
Height:	Outside Height	Openings	Shelves
	42"	3	3
	76 1/4" 88 1/4"	6 7	7 8

stores almost anything

Rivet-Span® Shelving

Rivet-Span is an economical and versatile hand-load storage product that is incredibly easy to assemble, yet strong. It starts with a simple, economical design. A unit consists of posts, horizontal beams, and wood decking.



- **Economical.** Low initial investment reduces shelving costs. Quick labor saving installation reduces set-up costs. Many sizes offered eliminate costly decking material cutting charges.
- **Strong.** Rivet-Span steel frame construction extends shelving life. Its rack-type connection between posts and beams provide strength and rigidity to carry heavy loads safely.
- **Flexible.** Rivet-Span allows access from any or all four sides. A variety of beams are available to accommodate a wide range of loads and in spans and depths wider and greater than conventional shelving.
- **Simple Assembly.** All components are universal (no lefts or rights, fronts or backs). Without the hassle of nuts, bolts or cross braces, Rivet-Span installation is quick and easy.

Rivet-Span® Shelving Units

Rivet-Span can be used as quick, low cost steel-wood shelving. Rivet-Span shelf units are ideal for double entry applications. It can be accessed from either front or back because no cross braces for stability are required.

- Designed for units up to 48" wide.
- Uses single rivet or double rivet low profile shelf supports.
- Uses full "perimeter" double rivet angle beams at the top and bottom levels for rigidity.
- Capacity per shelf: 240-450 pounds.
- Shelf levels adjust on 1 1/2" centers.
- T-posts provide additional savings for starter-adder shelving installations.

Unit Sizes

Widths:	36", 42", 48"
Depths:	12", 15", 18", 24", 30", 36"
Heights:	6'-12'

Beam Profiles

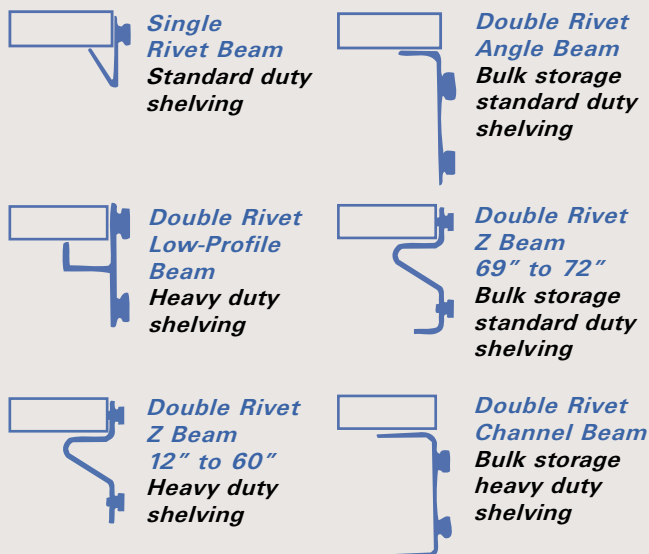

Bulk Storage Units

Rivet-Span bulk storage units are ideally suited to virtually any type of hand-loaded material. It is designed for greater cube capacity than standard shelving, and lower in price than pallet rack. Rivet-Span can be used for storing a broad range of bulky parts or hard-to-store items.

Shelving Units

- Designed for spans of 48" to 96" wide.
- Choice of beam capacity to meet your storage requirements.
- Uses double rivet angle, channel or Z beams.
- Capacity per beam: 700-2,200 lbs.
- Beam levels adjust on 1 1/2" centers.
- T-post adder units reduce material investment and installation time.

Unit Sizes

Widths:	24", 48", 60", 72", 84", 96"
Depths:	18", 24", 30", 32", 36", 42", 48"
Heights:	6'-12'



Archive Records & Specialty Applications

Special uses of Rivet-Span are limited only by the imagination of the individual. Some of the obvious uses are: archival records storage units, counter high units, workbenches and packing or receiving tables. Additionally, retail establishments can use Rivet-Span for back room storage.

Shoulder Rivets Beams have high strength shoulder rivets that engage in double keyhole post slots to form a strong and rigid unit.

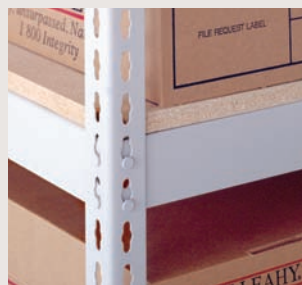

Record Storage Box Sizes

1 cubic foot size	= 12 7/8" W x 15 5/8" D x 10 1/2" H
1.5 cubic foot size	= 12 5/8" W x 24" D x 10 1/4" H



feature a built-in anti-tip safety system

Easy-Trak™ Bi-File & Tri-File Systems

Whether your needs are front office or back room, Easy-Trak saves floor space and increases storage capacity. Systems are available in two row (Bi-File) or three row (Tri-File) deep configurations, and can be utilized with Record Master® or Rivet Span® shelving. It is simply the best value in high-density filing and storage.



- **Easy to Install.** Installs quickly and easily on carpet, tile, wood or concrete floors. No special tools, complicated alignments or costly platforms are required.
- **Easy to Use.** Five pounds of pressure moves 1,300 pounds of load. Strong, unibody aluminum carriages provide a carrying capacity of 3,500 pounds.
- **Easy to Level.** The adjustable track can be leveled at any time, even long after installation and loading.

Regular Stationary Filing



Eight filing cabinets occupy 21.7 sq.ft. and provide 960 filing inches.

Borroughs Easy-Trak 3+2 System

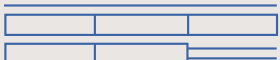

Five Record Master Units occupy 19.5 sq.ft. and provide 1,190 filing inches. 24% more files and 10% less space!

Anti-Tip System

Built-in carriage anti-tip arms float in rear track anti-tip rail. Arms do not contact the rail unless the unit tips, and, it is seismically approved.

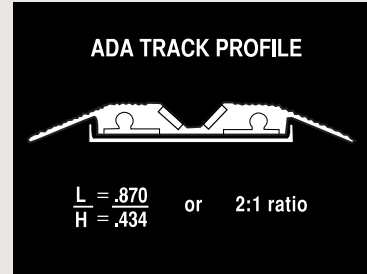

Track profile complies with ADA requirements.

ADA Compliant

Borroughs track complies with ADA regulations for barrier-free access.

Track Length

The track length is virtually unlimited through splicing. Longest one piece standard track lengths are determined by access for office, freight elevators and stairway.

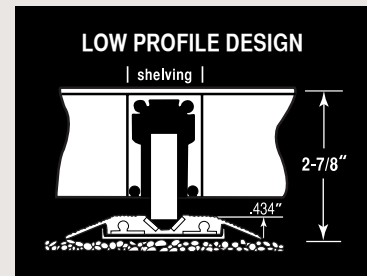

Steel wheels roll on steel strips encased in aluminum tracks.

Smooth, Quiet Operation

For safety and noise reduction, the carriages include rubber bump cushions. Wheels are hardened steel ball bearing races (permanently greased and sealed) and will not deform under loads on the steel track runners.

Configurations Available

Easy-Trak Bi-File: 2+1 systems through 6+5 systems.

Easy-Trak Tri-File: 2+1+1 systems through 6+5+5 systems.

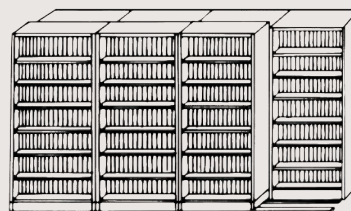

Bi-File System uses 4+3 configuration

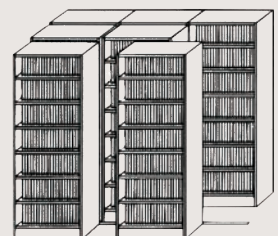

Tri-File System uses 3+2+2 configuration

save floor space and increase storage capacity

Easy-Trak™ Compacting Systems

Borroughs Easy-Trak systems increase capacity and save floor space. Easy-Trak can increase capacity by as much as 100% or save as much as 50% of your floor space. Stored items remain ready for quick and easy retrieval.

Easy-Trak converts aisles into valuable floor space by compacting rows of Borroughs library products into a single aisle configuration. With Easy-Trak mechanical-assist carriages, heavy loads move easily. The handle has a built-in carriage parking lock mechanism for safety.



Easy-Trak Mobile System

Easy-Trak utilizes carriage and track, installed directly on floor surface, to provide high-density filing and storage.

Versatile

Easy-Trak can be used with many Borroughs filing and storage units on carpet, tile, wood or concrete floors.

Easy Installation

Borroughs Easy-Trak systems install quickly unlike many mobile installations, which are permanent and expensive. Easy-Trak requires no special tools, no complicated alignments, costly platforms or expensive grouting. Our adjustable ADA compliant can be leveled at any time, even long after installation and loading.

Direct Drive Systems

Easy-Trak's economical answer for small high-density storage requirements. Direct Drive allows carriages up to 9' long. Its outstanding mechanical-assist chain and sprocket system creates savings by driving carriages directly along the track. With its 9:1 drive ratio, moving carriages is quick and easy. Direct Drive's durability record in hundreds of installations ensures the quality and reliability you need.

Responsive Drive Systems

Easy-Trak Responsive Drive System, or RDS, allows carriages up to 15' long! RDS drives the carriage wheels directly via a continuous drive shaft. This eliminates carriage lag problems associated with longer carriages and assures smooth and responsive movement of the entire carriage. RDS carriages use larger, extra-strength channels, angles and dual bearing wheels to carry RDS' larger and heavier loads. For practical and economical library storage solutions, you can count on Borroughs. We make smart use of space and help people be more productive.

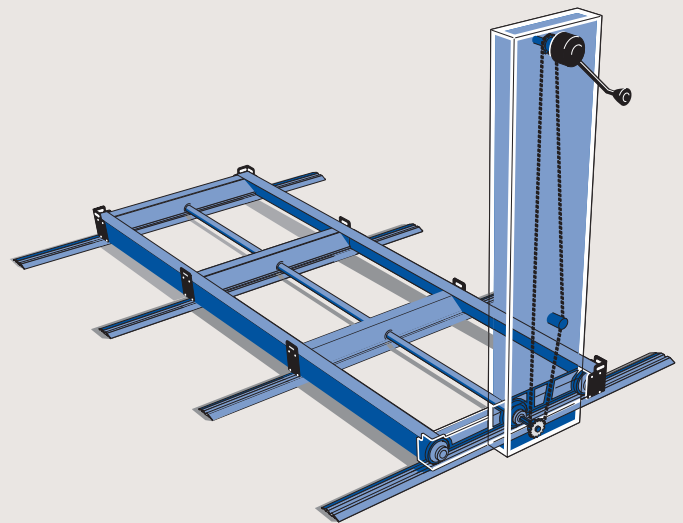

Responsive Drive System

Ergonomic one-spoke handle is used to operate the 16:1 ratio chain and sprocket gear box to drive front, middle and end wheels via drive shaft. Each 360° turn of the handle will move the carriage approximately 4.5".

maximize your filing and storage needs

Aisle-Saver[®] Mobile Storage Systems

Borroughs Aisle-Saver high density storage and retrieval systems can increase filing and storage density while increasing productivity, accuracy and supervisory control. Aisle-Saver products provide cost effective and highly efficient solutions for today's storage needs by providing both high density and quick accessibility.

Double Your Storage Capacity Without Adding Storage Space

The Aisle-Saver concept is simple. Shelving is mounted on moveable carriages, which ride on a sturdy leveled rail system. Carriage movement occurs, electronically, manually or with mechanical assistance. When the carriage is moved, an aisle is created to allow access to the stored media. By reducing the number of aisles needed, storage or filing density can be doubled within an existing area or the space required for storage can be reduced by up to 50%.

Aisle-Saver Synergy Series[™] Key Features

Users can select from a wide variety of available options for safety, access, convenience and security.

- Easy to upgrade as new features become available.
- A 36" aisle opens in as little as 8 seconds.
- Available in electrical, mechanical assist and manual models.
- Accepts loads up to 1000 pounds per lineal foot.
- Carriage lengths available from 3' to 60'.
- Carriage widths from 15" to 60".
- All systems carry a five-year warranty.
- Complies with ADA regulations for accessibility.

Aisle-Saver Benefits

- Superior aesthetics – clean lines, no exposed fasteners.
- Ease of carriage movement.
- Safety lock feature for operator protection.
- Easy maintenance without uploading stored materials.
- All exposed metal surfaces are painted.



Electrical Assist Aisle-Saver - the ultimate in high density storage systems. With the push of a button, an aisle can be created when and where needed. Smart technology and user-friendly controls provide safe, reliable performance.



Mechanical Assist Aisle-Saver – an economical alternative to the ELS Model. An ergonomically designed handle makes carriage movement fast and easy.

Aisle-Saver Lateral System



High Density Lateral Storage Systems – ideal for perimeter wall installations or for narrow situations, where other forms of high density storage are inappropriate.

- Two-row and three-row deep systems are available.
- Section widths: 3', 3.5' or 4'.
- Carriage depths: 10", 12", 13.2", 15" and 18".
- Anti-tip safety designed into the deck and track.
- Case hardened steel bearing wheels provide effortless side to side movement.
- Sections are reconfigurable - as requirements change.

Aisle-Saver Face Panel Options

Aisle-Saver carriages, frames and skins are available in 21 standard Borroughs powder coat colors or in custom colors to match any decor. End panels are available in painted steel (skin) or a variety of laminates, wood, fabric or custom inserts. Aisle-Saver offer a wide range of styles – euro-style, full-height, half-height or pedestal.

Skin Face Panel with 3-spoke handle



Laminate Panel with Carriage Control Pad

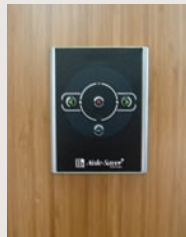

Aisle-Saver Applications

Aisle-Saver systems are designed to be used with new or existing shelving or cabinets. They can store information in the form of paper, electronic media or three dimensional objects. There is no need to accept a one-size-fits-all answer to your storage needs. With Aisle-Saver Synergy Series you can choose Record Master® Four-Post, Record Master® Heavy-Duty shelving or Rivet-Span storage.



Four-Post Heavy-Duty Record Master on Aisle-Saver

Record Master Case-Style Library Shelving on Electrical Assist Aisle-Saver



Rivet-Span on Aisle-Saver is housing inactive records in large archive boxes.

Four-Post Record Master on Aisle-Saver



Borroughs Standard Powder Coat Colors

Borroughs powder coat finishes are high quality, durable and inert. Office products are available in a wide variety of standard and custom colors. For specific color policies, please refer to Borroughs Powder Coat Color Guide or contact Customer Service.

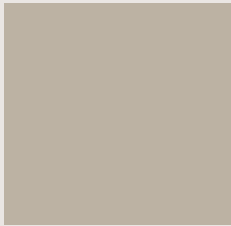

010 Autumn Haze

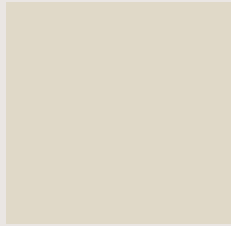

159 Eggshell

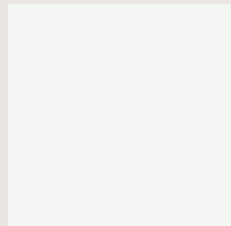

445 White

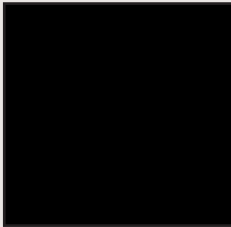

040 Black

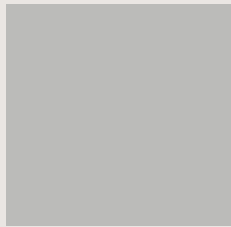

161 Mist Gray

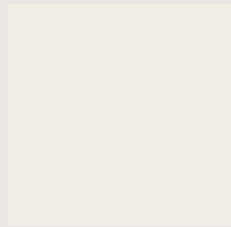

D492 Parchment

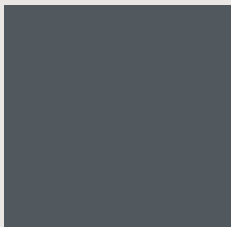

065 Industrial Gray

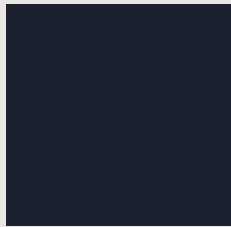

165 Forest Gray

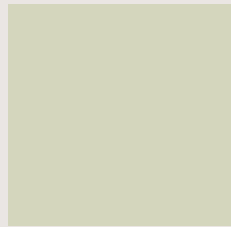

F604 Pebble

The colors depicted on this publication have been reproduced using a printing process and are only provided as a guide. The actual painted product may vary. All colors are not available on all products. Please contact your Borroughs Dealer for details.



Material Handling USA
222 S. Main St. 5th Floor, Salt Lake City, UT 84101 |
Sales@MH-USA.com | <https://www.mh-usa.com/> |
800-326-4403

ISO 9001:2000 Registered **ISO 14001:2004 Registered**



<https://www.mh-usa.com/>

Printed in the U.S.A.
© 2009 Borroughs Corporation
Form # OSS 51397- 0309