



# **AUTOMOTIVE WORKSTATIONS**

Borroughs automotive workstations for vehicle servicing, diagnostic, and repair work



**Material Handling USA**

**Call Now for a Free  
Quote or Site Visit!**

222 S. Main St. 5th Floor  
Salt Lake City, UT 84101  
800-326-4403  
<https://www.mh-usa.com/>

SUPERSTORE

MH-USA

Material Handling USA



---

# MADE BY PROFESSIONALS FOR PROFESSIONALS.

---



*PICTURED WITH STAINLESS STEEL LEGS & STAINLESS STEEL  
KICK PLATES AND A WORK SURFACE HEIGHT OF 41<sup>5/8</sup>".*

## LIMITED LIFETIME WARRANTY

Borroughs Corporation extends to the original purchaser from the date of purchase a lifetime limited warranty against manufacturing defects in material and workmanship. If a Borroughs product fails to perform because of a manufacturing defect, Borroughs will examine it. If found defective, it will be repaired or replaced at our option. This warranty applies only to Borroughs products acquired directly from Borroughs Corporation or from Authorized Borroughs Dealers. This warranty does not apply to any product which has been subject to misuse, negligence, or accident; has been damaged in shipment, storage, or installation; has been misapplied

**OUR MISSION WAS SIMPLE** – design a workstation that automotive industry technicians & service professionals will feel they designed themselves.

Borroughs automotive workstations meet every need you have, and every need you will have. Our automotive workstations are rugged, durable, easily customizable, and shockingly affordable.



*PICTURED WITH FORK TRUCK BASE & BASE COVERS  
AND A WORK SURFACE HEIGHT OF 38<sup>5/8</sup>".*

or has been modified or repaired by unauthorized persons or been repaired with non-standard Borroughs replacement parts. This warranty specifically excludes claims for indirect, incidental, or consequential damages arising in any way from a product defect. This warranty is exclusive, and exists in lieu of all other warranties, either expressed or implied. This warranty gives you specific legal rights; you may also have other rights which may vary from state to state. Contact your Borroughs Selling Dealer, to obtain warranty service. You must make a written claim. Provide a copy of your purchase record and a written description of the warranty problem with your claim.



## THE BORROUGHS DIFFERENCE

**BORROUGHS HAS DESIGNED, REFINED** and rigorously tested our new automotive workstations. We started on the outside with sleek new upper cabinets complete with stainless steel accents – as a standard. Then we streamlined the handles and hid fasteners on lower cabinets to create a modern, sleek look - that will stand up to everyday abuse as well as impress customers. Finally, we engineered our components to be seamlessly mixed and matched for just the right configuration to meet your specific needs.

Now take a look under the hood. We manufacture the industry's strongest tool drawers with a quiet self-close feature. We designed our upper cabinets to use minimal effort to open, with a standard soft close mechanism. We even researched placement of storage, to reduce your technician's footsteps and speed up service. The final result – A Borroughs workstation that runs smoothly and efficiently.

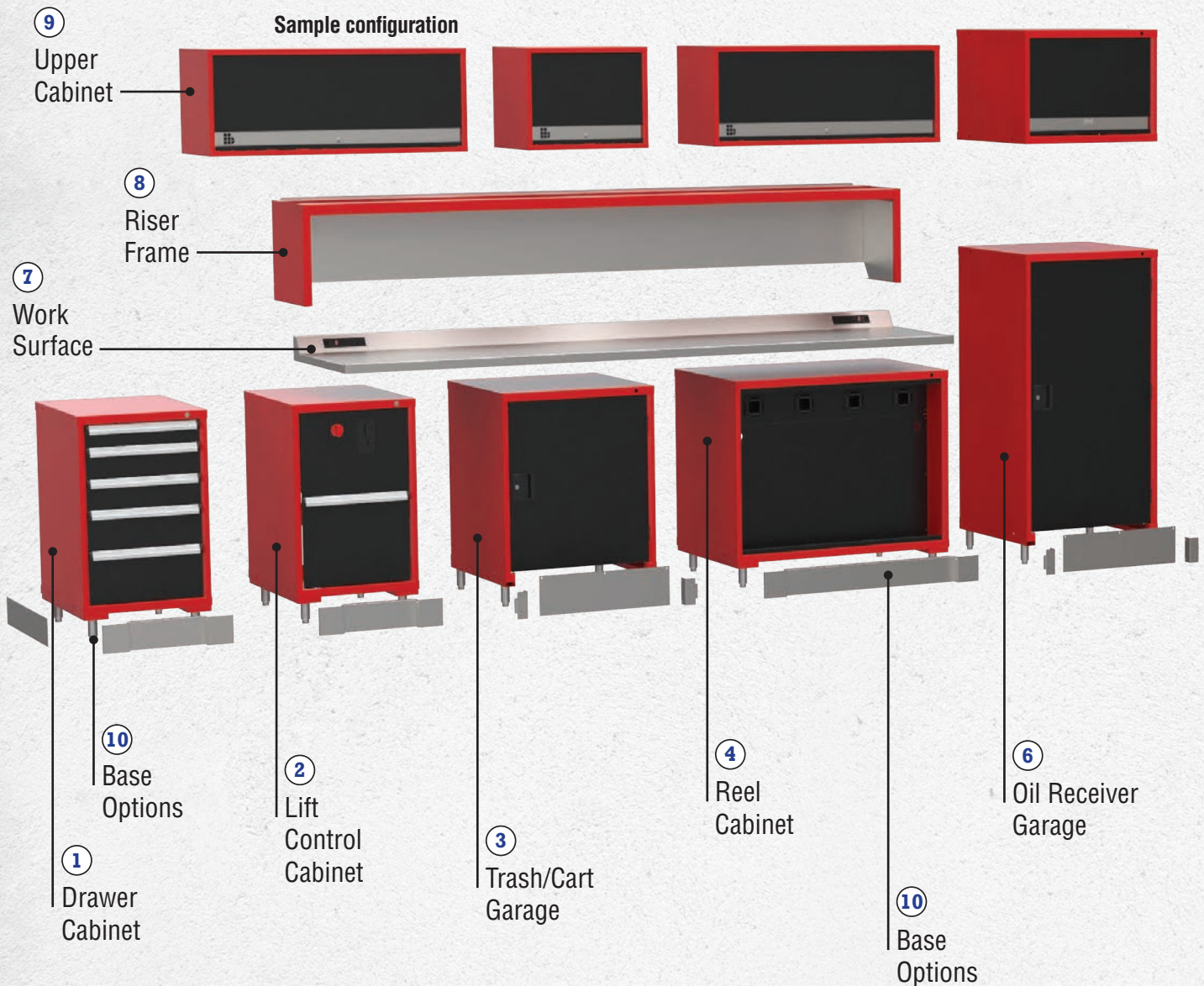

## BUSINESS DRIVEN FEATURES & BENEFITS

- Drawers feature best slides in the industry with 110% drawer extension. This allows for technicians to quickly locate tools or hardware in the back of the drawers.
- Upper cabinets are intentionally designed so technicians can lift the door with one hand– without torquing or twisting. This allows for faster retrieval of supplies, manuals or stowed away items.
- All locks boast a removable core to easily change if necessary, and can be keyed alike or individually, for your security needs.
- Lift and reel cabinets feature knock-out back and bottom panels for easy installation of utilities, and integrate seamlessly into the workstations.
- Clean, well designed workstations help brand your business, increases customer return rate, and increases productivity and technician retention rates.

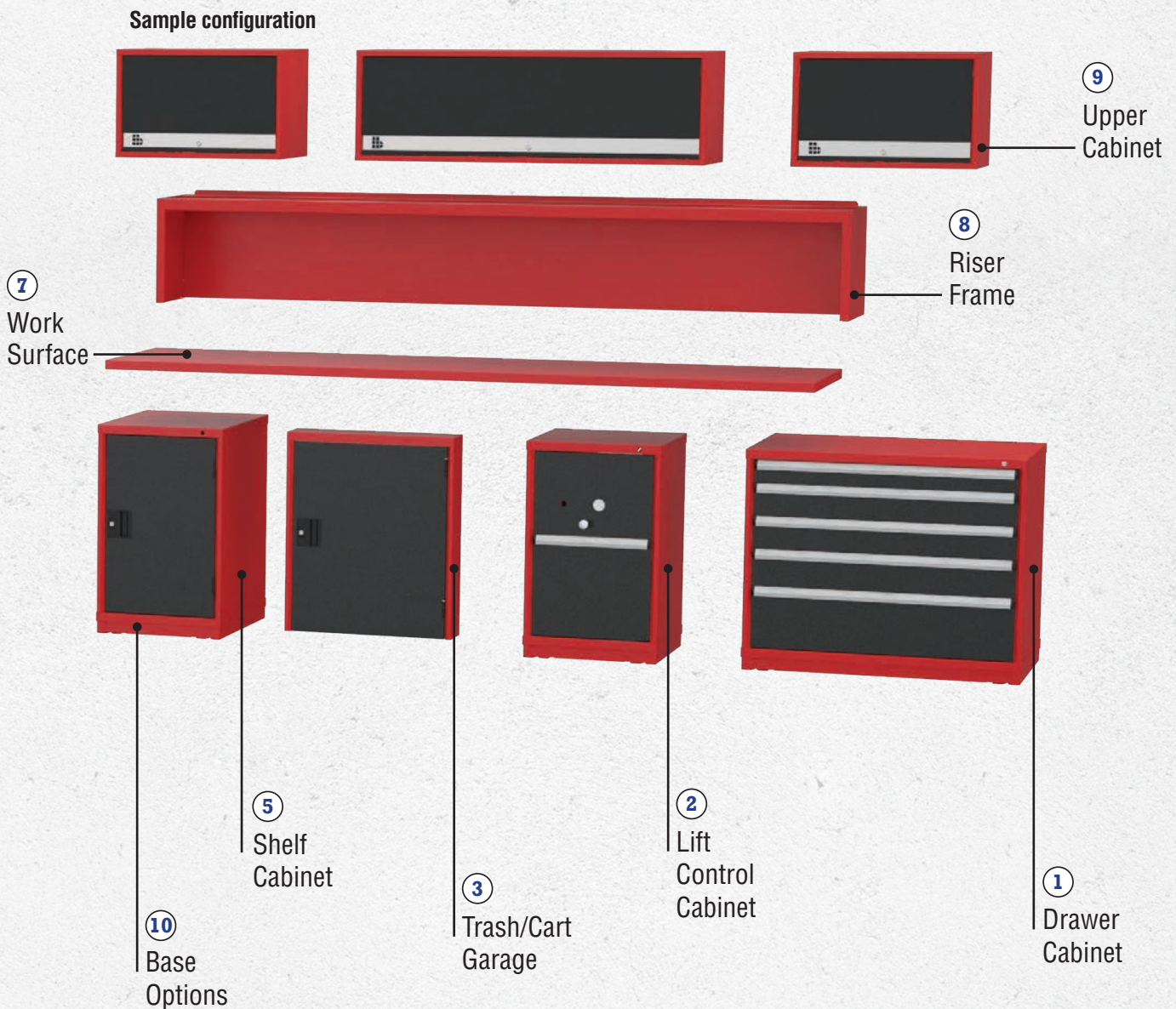



# WORKSTATION COMPONENTS

OUR TECHNICAL SUPPORT TEAM is always available to assist you in the configuration of any Borroughs workstation. With that in mind, we have provided illustrations of key components that make up the majority of today's service workstations. **Build your station in 5 steps**, which we have outlined at the bottom of the following pages.



## DRAWER CABINETS

- 400 lb. capacity w/ 110% full extension for full access to back of drawer.
- Auto-safety clips lock the suspension to the drawer, preventing accidental release.
- All drawers are supplied with a black, polyester mesh liner.
- Ergonomic handles are flush with housing, full-width, and are located at the top of each drawer.
- Drawers are perfect for tool and/or bulk storage.

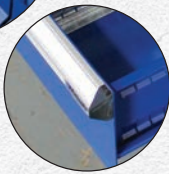
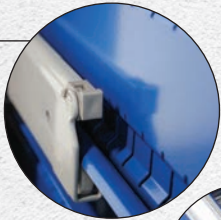

## LIFT CONTROL CABINETS

- All cabinets feature 6" x 12" knock-out panels located on back and bottom of cabinet for easy field-access to utility hook-ups.
- Available in three (3) styles:

**Rotary Inbay Lift Control**

**Challenger Lift Control**

**Rotary Shockwave Lift Control**

*Note: Knock-outs are not in the bottom pan of 23" D cabinets.*

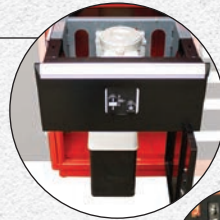

## CART/TRASH GARAGES

- Provides open-base access for the storage of mobile products like service carts and trash containers.
- Features a lockable swing door for security.
- Available in two (2) styles:

**Full-Sided Garage** cabinet that is available with either a stainless leg base or a fork truck base.

**Single-Sided Garage** is a welded frame that supports the door and is attached to adjacent cabinets.



## CREATING YOUR WORK STATION IN 5 STEPS

### STEP 1

What components will you have under your work surface? Some things to keep in mind are:

- How much tool space is needed?
- Will your techs use a dual workstation?
- Where are utilities located (overhead or under)?
- What type of lift control do you use?

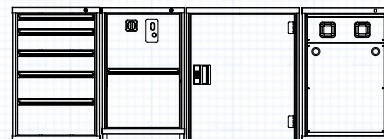
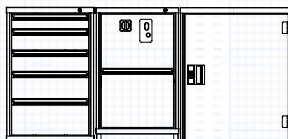
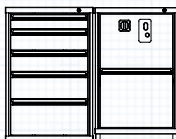
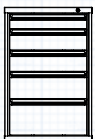

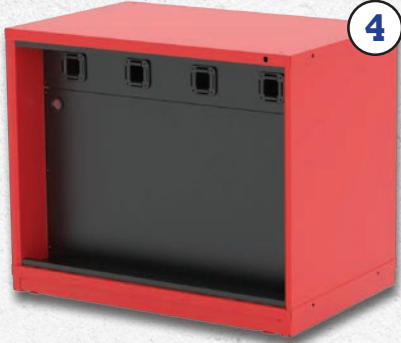

**REEL CABINETS**

- Offers integrated, easy-access to power, liquids, or air hose reels.
- All units feature 6" x 12" knock-out panels located on back and bottom of cabinet for easy field-access to utility hook-ups.
- All hose ends are recessed into the cabinet face eliminating aisle protrusions.
- Includes cabinet face roller guides, for faster and easier reel use.
- Includes a drip tray with a removable liquid absorbing insert for easy cleaning.

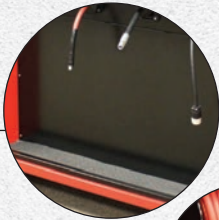

**SHELF CABINETS**

- Includes (1) bottom shelf and (1) adjustable shelf.
- Swing doors are reinforced to provide security for bulky items stored on shelves.
- Unique die-cast pull handle with a 3-point locking system.



**OIL RECEIVER GARAGE**

- Cabinet that features an open bottom and a lockable swing door.
- Provides open-base access for the storage of a mobile oil waste receiver.
- Stand-alone unit located adjacent to the work surface.
- Features an adjustable shelf located just above the oil receiver.



- How much space is available?
- Do I need trash/cart space?

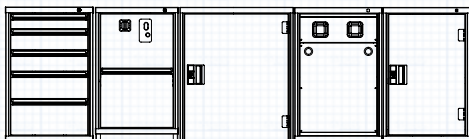

- Do I need space for larger items?
- Do I need storage for oil refuse?

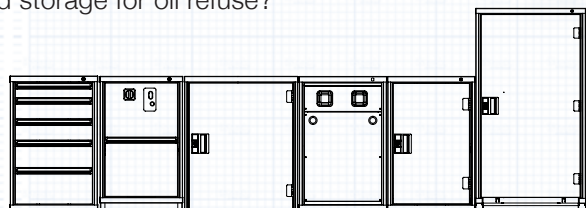

**NEXT STEP**



# WORKSTATION COMPONENTS

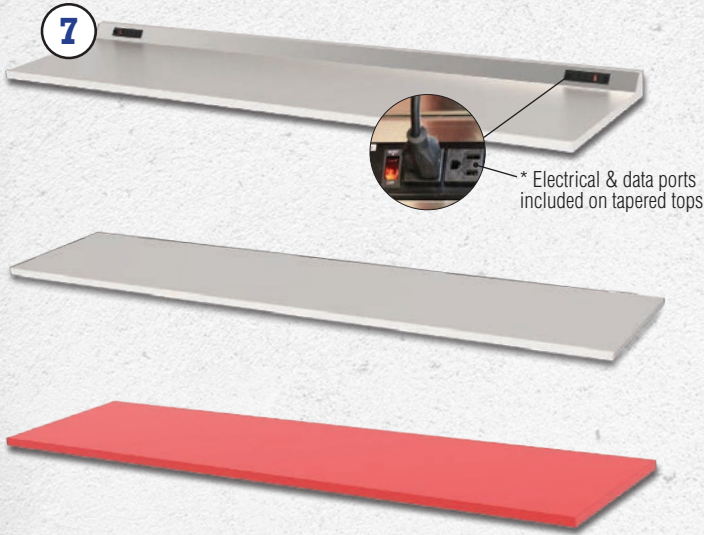

## WORK SURFACES

- Installed with a 3/4" overhang at front edge of the lower cabinets.
- All work surfaces measure 30"D x 1<sup>5/8</sup>" thick.
- All work surfaces are flush at the rear, and have a solid wood core.
- Available in three (3) styles all constructed from 16-gauge steel:

\* **Tapered Stainless Steel Top**

**Stainless Steel Top**

**Painted Steel Top**

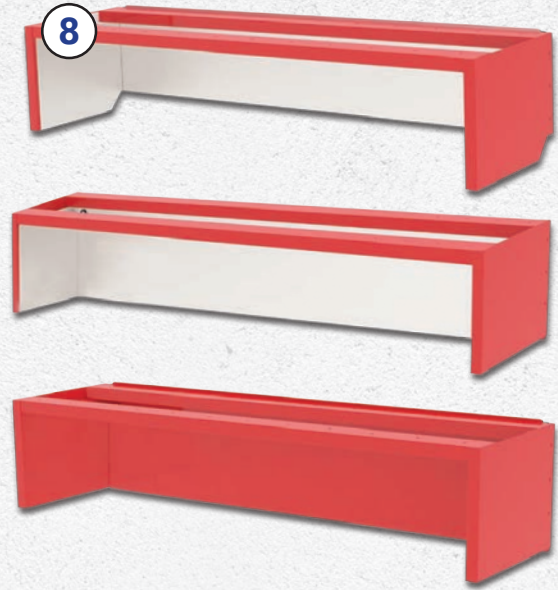

## RISER FRAMES

- Designed to support the upper cabinets without requiring cantilevered support, requires minimal fasteners to assemble, while providing a clear-open work area underneath.
- Heavy-duty framework mounts to panels at each end of the work surface and to a rear chase panel at back.
- Panel in panel end design provides clean aesthetics that covers the attachment fasteners.
- Open channel-frame provides for hidden cable management.
- Available in three (3) styles:

**Riser Frame Tapered** *(This option is only applicable to the tapered work surface)*

**Riser Frame Stainless**

**Riser Frame Painted**

## CREATING YOUR WORK STATION IN 5 STEPS

**STEP 2**  
see page 13

What type of work surface?

- Do you need electric, or data inputs?

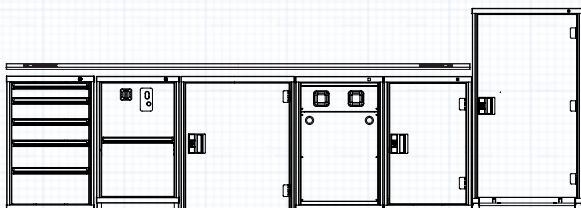

**STEP 3**  
see page 15

Do I need Upper Cabinet Storage?

- Are uppers mounted to a wall or riser?
- Do I need computer monitor storage?

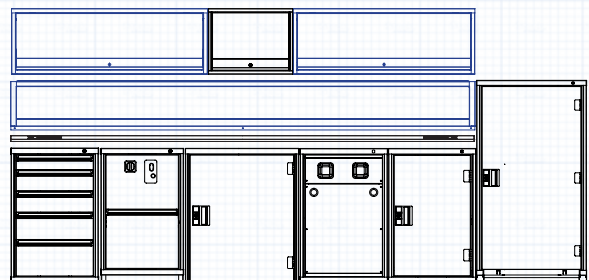





**UPPER CABINETS**

- Strongest and most spacious upper cabinets in the industry measuring 18"D x 19"H.
- Tip-up, slide-in doors mounted to "rack & pinion" slides provide single-hand operation.
- Soft-close with built-in dampers, helps longevity of cabinets.
- Can be mounted easily atop riser frame or can be wall-mounted.

*Optional Computer Support Arm Kit.  
Optional Undercounter Task Lighting Kit.*

**10 BASE OPTIONS**



**STAINLESS STEEL LEGS**

- Provides a work surface height of 41<sup>5/8</sup>".
- Each stainless steel leg can be adjusted vertically to provide system leveling.
- Allows for cleaning of liquid prone areas.



**STAINLESS STEEL KICK-PLATES**

- Optional 14-gauge stainless steel kick-plates can be **ordered separately** to cover the stainless steel leg bases.



**FORK TRUCK BASE**

- Provides a work surface height of 38<sup>5/8</sup>".
- Economic alternative to adjustable leg bases.
- A snap-in cover completes the assembly, providing a clean aesthetic.



**Do I need Riser Frames?**

- Do I need support for upper cabinets?
- Do I need a chase panel?

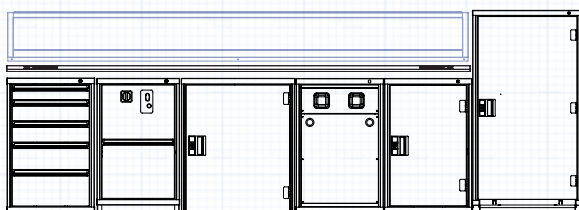

**What working height & color?**

- Do I want stainless steel legs?
- Do I want fork truck bases?
- What color should I order?

Stainless Steel Leg Working Height

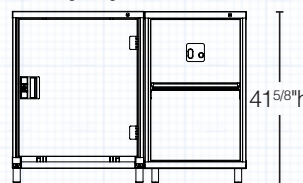

Fork Truck Base Working Height

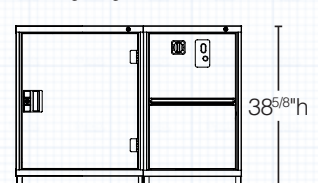



# 1 DRAWER CABINETS

All Automotive Workstation lower components come standard with fork truck bases and covers.  
 Replace "FT" in the part number with "SL" for stainless steel leg base.

## 23" Wide Cabinets

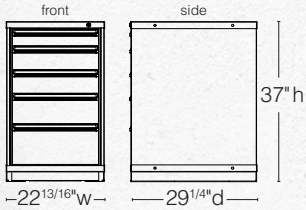
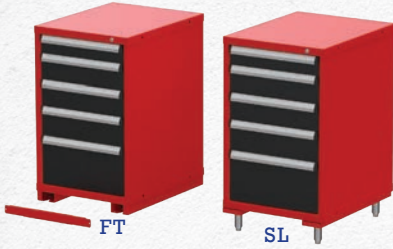

NOTE: STAINLESS STEEL LEG BASES HAVE A HEIGHT OF 40".

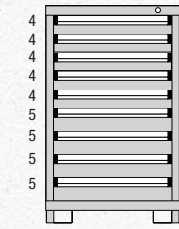

A1-232940FT-MD09AM

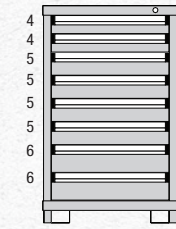

A1-232940FT-MD08AM

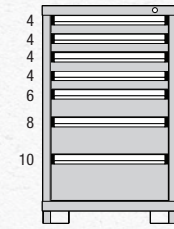

A1-232940FT-MD07AM

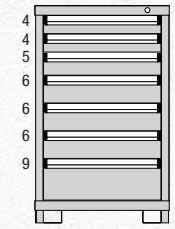

A1-232940FT-MD07BM

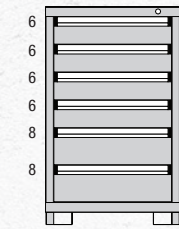

A1-232940FT-MD06BM

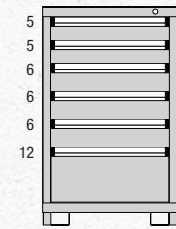

A1-232940FT-MD06CM

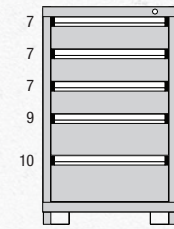

A1-232940FT-MD05AM

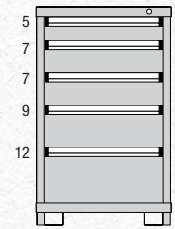

A1-232940FT-MD05BM

Drawer Table	Drawer Number	4	5	6	7	8	9	10	11	12	13	14	15	16	17	18	
	Usable Height	2 1/4"	3 1/16"	3 7/8"	4 5/8"	5 7/16"	6 1/4"	7"	7 3/4"	8 9/16"	9 3/8"	10 1/8"	10 15/16"	11 3/4"	12 1/2"	13 5/16"	
	Drawer Size	Small			Medium				Large								

## 30" Wide Cabinets

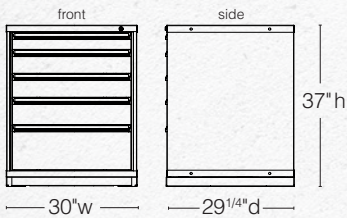
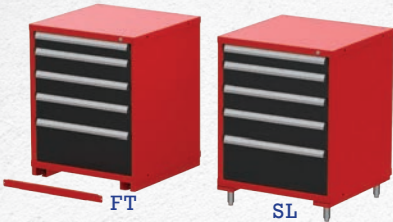

NOTE: STAINLESS STEEL LEG BASES HAVE A HEIGHT OF 40".

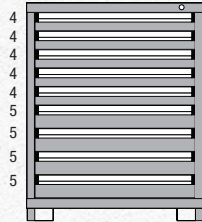

A1-302940FT-MD09DM

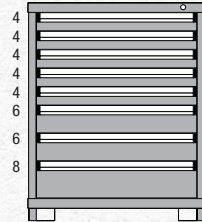

A1-302940FT-MD08DM

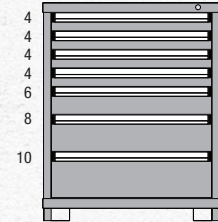

A1-302940FT-MD07AM

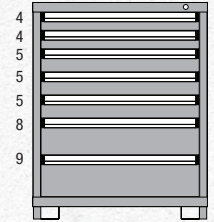

A1-302940FT-MD07DM

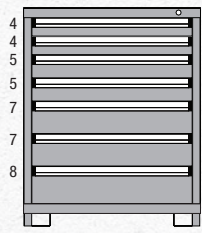

A1-302940FT-MD07FM

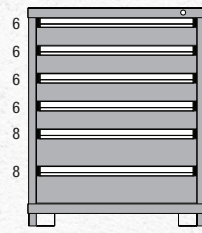

A1-302940FT-MD06AM

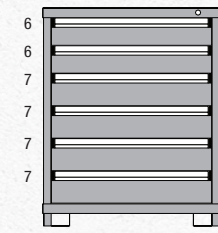

A1-302940FT-MD06BM

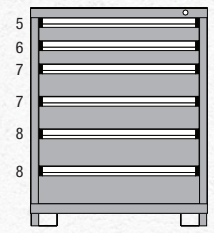

A1-302940FT-MD06DM

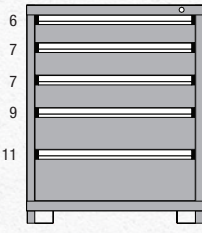

A1-302940FT-MD05BM

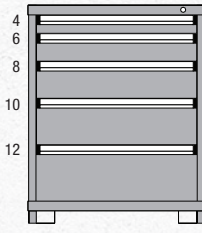

A1-302940FT-MD05DM

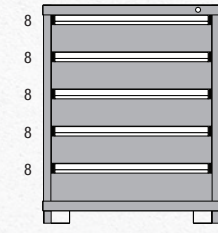

A1-302940FT-MD05FM

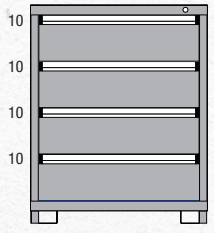

A1-302940FT-MD04DM



# 1 DRAWER CABINETS

All Automotive Workstation lower components come standard with fork truck bases and covers.  
 Replace "FT" in the part number with "SL" for stainless steel leg base.

## 45" Wide Cabinets

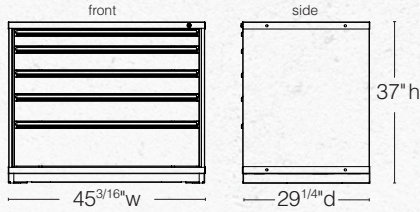
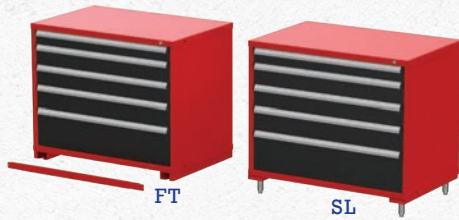

NOTE: STAINLESS STEEL LEG BASES HAVE A HEIGHT OF 40".

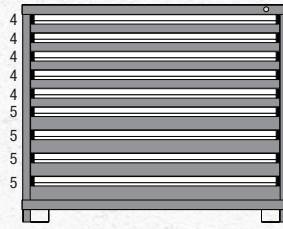

A1-452940FT-MD09AM

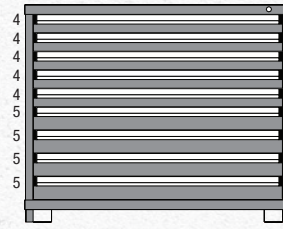

A1-452940FT-MD09BM

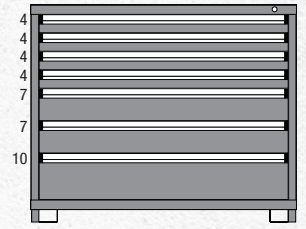

A1-452940FT-MD07AM

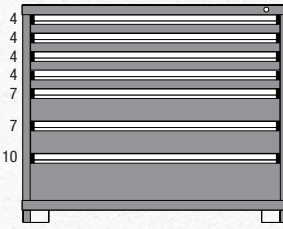

A1-452940FT-MD07BM

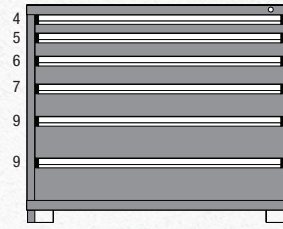

A1-452940FT-MD06AM



A1-452940FT-MD05AM

Drawer Number	4	5	6	7	8	9	10	11	12	13	14	15	16	17	18
Usable Height	2 1/4"	3 1/16"	3 7/8"	4 5/8"	5 7/16"	6 1/4"	7"	7 3/4"	8 9/16"	9 3/8"	10 1/8"	10 15/16"	11 3/4"	12 1/2"	13 5/16"
Drawer Size	Small			Medium				Large							

## 60" Wide Cabinets

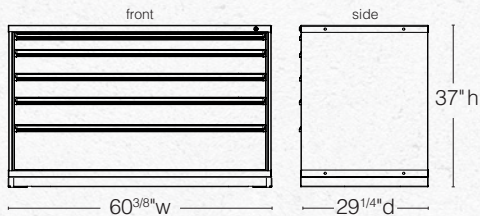
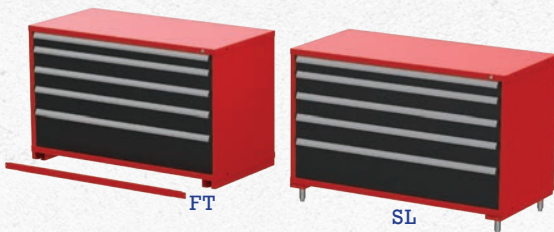

NOTE: STAINLESS STEEL LEG BASES HAVE A HEIGHT OF 40".



A1-602940FT-MD09AM



A1-602940FT-MD07AM

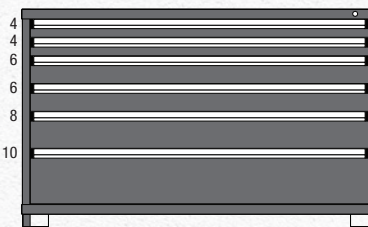

A1-602940FT-MD06AM



A1-602940FT-MD05AM

## 10 STAINLESS STEEL KICK-PLATES (OPTIONAL FEATURE USED WITH STAINLESS STEEL LEG BASE)



A1-23SKP (23W Face)

A1-60SKP (60W Face)

A1-30SKP (30W Face)

A1-29SKPE (Ends)

A1-45SKP (45W Face)

A1-30SKPD (30W Garage)



## 2 LIFT CONTROL CABINETS

All Automotive Workstation lower components come standard with fork truck bases and covers.  
Replace "FT" in the part number with "SL" for stainless steel leg base.

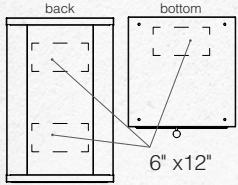

Knock-outs in the back & bottom of unit provide easy access for utility hook-ups.

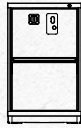

**A1-232940FT-RSW**

Lift Control Cabinet **Rotary Shockwave** Fork Truck Base

Width x Depth x Height

22<sup>13/16"</sup> x 29<sup>1/4"</sup> x 37"

**A1-232940SL-RSW**

Lift Control Cabinet **Rotary Shockwave** Stainless Leg Base

22<sup>13/16"</sup> x 29<sup>1/4"</sup> x 40"

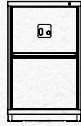

**A1-232340FT-RIB**

Lift Control Cabinet **Rotary InBay** Fork Truck Base

22<sup>13/16"</sup> x 23<sup>3/8"</sup> x 37"

**A1-232340SL-RIB**

Lift Control Cabinet **Rotary InBay** Stainless Leg Base

22<sup>13/16"</sup> x 23<sup>3/8"</sup> x 40"

**A1-232940FT-RIB**

Lift Control Cabinet **Rotary InBay** Fork Truck Base

22<sup>13/16"</sup> x 29<sup>1/4"</sup> x 37"

**A1-232940SL-RIB**

Lift Control Cabinet **Rotary InBay** Stainless Leg Base

22<sup>13/16"</sup> x 29<sup>1/4"</sup> x 40"

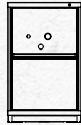

**A1-232340FT-CHL**

Lift Control Cabinet **Challenger** Fork Truck Base

22<sup>13/16"</sup> x 23<sup>3/8"</sup> x 37"

**A1-232340SL-CHL**

Lift Control Cabinet **Challenger** Stainless Leg Base

22<sup>13/16"</sup> x 23<sup>3/8"</sup> x 40"

**A1-232940FT-CHL**

Lift Control Cabinet **Challenger** Fork Truck Base

22<sup>13/16"</sup> x 29<sup>1/4"</sup> x 37"

**A1-232940SL-CHL**

Lift Control Cabinet **Challenger** Stainless Leg Base

22<sup>13/16"</sup> x 29<sup>1/4"</sup> x 40"

## 3 TRASH/CART GARAGES

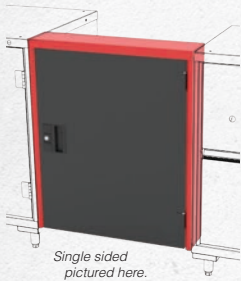

**A1-302940FT-FSG**

**Full Sided** Garage - Fork Truck Base

Width x Depth x Height

30" x 29<sup>1/4"</sup> x 37"

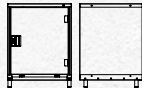

**A1-302940SL-FSG**

**Full Sided** Garage - Stainless Leg Base

30" x 29<sup>1/4"</sup> x 40"



**A1-3040-SSG**

**Single Sided** Garage (No Base)

30" x 6<sup>1/4"</sup> x 40"



**A1-MWC**  
(other colors available)

**MOBILE WASTE CART**

22" Dia. x 34<sup>7/8"</sup> H

## 4 REEL CABINETS

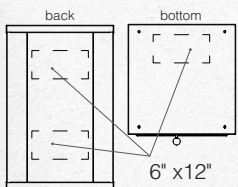

Knock-outs in the back & bottom of unit provide easy access for utility hook-ups.

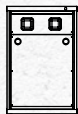

**A1-232940FT-2RL**

**2-Reel** Cabinet Fork Truck Base

Width x Depth x Height

22<sup>13/16"</sup> x 29<sup>1/4"</sup> x 37"



**A1-232940SL-2RL**

**2-Reel** Cabinet Stainless Leg Base

22<sup>13/16"</sup> x 29<sup>1/4"</sup> x 40"

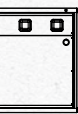

**A1-302940FT-3RL**

**3-Reel** Cabinet Fork Truck Base

30" x 29<sup>1/4"</sup> x 37"



**A1-302940SL-3RL**

**3-Reel** Cabinet Stainless Leg Base

30" x 29<sup>1/4"</sup> x 40"

**A1-452940FT-4RL**

**4-Reel** Cabinet Fork Truck Base

45<sup>3/16"</sup> x 29<sup>1/4"</sup> x 37"

**A1-452940SL-4RL**

**4-Reel** Cabinet Stainless Leg Base

45<sup>3/16"</sup> x 29<sup>1/4"</sup> x 40"

## 5 SHELF CABINETS

All Automotive Workstation lower components come standard with fork truck bases and covers.  
 Replace "FT" in the part number with "SL" for stainless steel leg base.



23" Shelf Cabinets

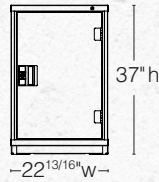

with door

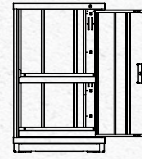

A1-232940FT-S2FH DN

without door

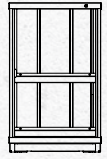

A1-232940FT-S2ND NN

Note: Stainless steel leg bases have a height of 40".

30" Shelf Cabinets

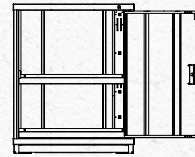
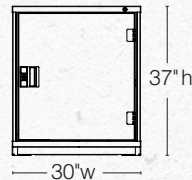

A1-302940FT-S2FH DN

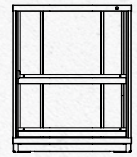

A1-302940FT-S2ND NN

### 10 CABINET BASE OPTIONS



STAINLESS STEEL LEGS

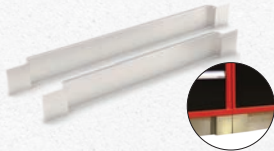

STAINLESS STEEL KICK-PLATES



FORK TRUCK BASE

45" Shelf Cabinets

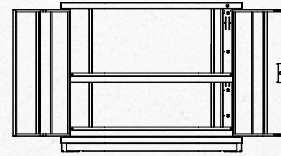
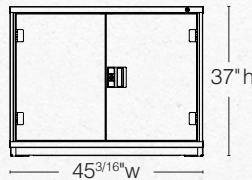

A1-452940FT-S2FH DN

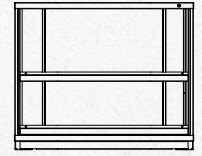

A1-452940FT-S2ND NN

60" Shelf Cabinets

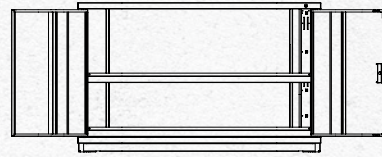
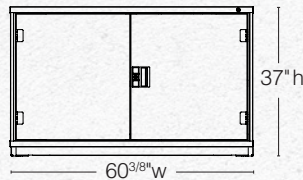

A1-602940FT-S2FH DN

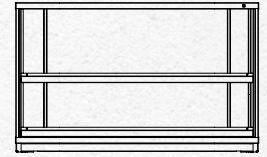

A1-602940FT-S2ND NN

## 6 OIL RECEIVER GARAGE

Width x Depth x Height



A1-302968FT-ORG

Oil Receiver Garage Fork Truck Base

30" x 29 1/4" x 59"



A1-302968SL-ORG

Oil Receiver Garage Stainless Leg Base

30" x 29 1/4" x 62"



# 7 WORK SURFACES



## TAPERED STAINLESS STEEL

\* If a riser frame is ordered it must use a painted riser with stainless steel tapered chase.

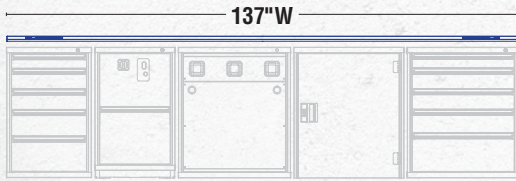

Sample configuration

		Width x Depth x Height
A1-04630TSST	Tapered Stainless Top Kit	46" x 30" x 1 <sup>5</sup> / <sub>8</sub> "
A1-05430TSST	Tapered Stainless Top Kit	54" x 30" x 1 <sup>5</sup> / <sub>8</sub> "
A1-06130TSST	Tapered Stainless Top Kit	61" x 30" x 1 <sup>5</sup> / <sub>8</sub> "
A1-06930TSST	Tapered Stainless Top Kit	69" x 30" x 1 <sup>5</sup> / <sub>8</sub> "
A1-07630TSST	Tapered Stainless Top Kit	76" x 30" x 1 <sup>5</sup> / <sub>8</sub> "
A1-08430TSST	Tapered Stainless Top Kit	84" x 30" x 1 <sup>5</sup> / <sub>8</sub> "
A1-09230TSST	Tapered Stainless Top Kit	92" x 30" x 1 <sup>5</sup> / <sub>8</sub> "
A1-09930TSST	Tapered Stainless Top Kit	<b>99" x 30" x 1<sup>5</sup>/<sub>8</sub>"</b>
A1-10630TSST	Tapered Stainless Top Kit	<b>106" x 30" x 1<sup>5</sup>/<sub>8</sub>"</b>
A1-11430TSST	Tapered Stainless Top Kit	<b>114" x 30" x 1<sup>5</sup>/<sub>8</sub>"</b>
A1-12230TSST	Tapered Stainless Top Kit	<b>122" x 30" x 1<sup>5</sup>/<sub>8</sub>"</b>
A1-12930TSST	Tapered Stainless Top Kit	<b>129" x 30" x 1<sup>5</sup>/<sub>8</sub>"</b>
A1-13730TSST	Tapered Stainless Top Kit	<b>137" x 30" x 1<sup>5</sup>/<sub>8</sub>"</b>
A1-14430TSST	Tapered Stainless Top Kit	<b>144" x 30" x 1<sup>5</sup>/<sub>8</sub>"</b>



## STAINLESS STEEL



Sample configuration

M1-04630SST	Stainless Top Kit	46" x 30" x 1 <sup>5</sup> / <sub>8</sub> "
M1-05430SST	Stainless Top Kit	54" x 30" x 1 <sup>5</sup> / <sub>8</sub> "
M1-06130SST	Stainless Top Kit	61" x 30" x 1 <sup>5</sup> / <sub>8</sub> "
M1-06930SST	Stainless Top Kit	69" x 30" x 1 <sup>5</sup> / <sub>8</sub> "
M1-07630SST	Stainless Top Kit	76" x 30" x 1 <sup>5</sup> / <sub>8</sub> "
M1-08430SST	Stainless Top Kit	84" x 30" x 1 <sup>5</sup> / <sub>8</sub> "
M1-09230SST	Stainless Top Kit	92" x 30" x 1 <sup>5</sup> / <sub>8</sub> "
M1-09930SST	Stainless Top Kit	99" x 30" x 1 <sup>5</sup> / <sub>8</sub> "
M1-10630SST	Stainless Top Kit	106" x 30" x 1 <sup>5</sup> / <sub>8</sub> "
M1-11430SST	Stainless Top Kit	114" x 30" x 1 <sup>5</sup> / <sub>8</sub> "
M1-12230SST	Stainless Top Kit	122" x 30" x 1 <sup>5</sup> / <sub>8</sub> "
M1-12930SST	Stainless Top Kit	129" x 30" x 1 <sup>5</sup> / <sub>8</sub> "
M1-13730SST	Stainless Top Kit	137" x 30" x 1 <sup>5</sup> / <sub>8</sub> "
M1-14430SST	Stainless Top Kit	144" x 30" x 1 <sup>5</sup> / <sub>8</sub> "



## PAINTED TOP



Sample configuration

M1-04630PST	Painted Steel Top Kit	46" x 30" x 1 <sup>5</sup> / <sub>8</sub> "
M1-05430PST	Painted Steel Top Kit	54" x 30" x 1 <sup>5</sup> / <sub>8</sub> "
M1-06130PST	Painted Steel Top Kit	61" x 30" x 1 <sup>5</sup> / <sub>8</sub> "
M1-06930PST	Painted Steel Top Kit	69" x 30" x 1 <sup>5</sup> / <sub>8</sub> "
M1-07630PST	Painted Steel Top Kit	76" x 30" x 1 <sup>5</sup> / <sub>8</sub> "
M1-08430PST	Painted Steel Top Kit	84" x 30" x 1 <sup>5</sup> / <sub>8</sub> "
M1-09230PST	Painted Steel Top Kit	92" x 30" x 1 <sup>5</sup> / <sub>8</sub> "
M1-09930PST	Painted Steel Top Kit	99" x 30" x 1 <sup>5</sup> / <sub>8</sub> "
M1-10630PST	Painted Steel Top Kit	106" x 30" x 1 <sup>5</sup> / <sub>8</sub> "
M1-11430PST	Painted Steel Top Kit	114" x 30" x 1 <sup>5</sup> / <sub>8</sub> "
M1-12230PST	Painted Steel Top Kit	122" x 30" x 1 <sup>5</sup> / <sub>8</sub> "
M1-12930PST	Painted Steel Top Kit	129" x 30" x 1 <sup>5</sup> / <sub>8</sub> "
M1-13730PST	Painted Steel Top Kit	137" x 30" x 1 <sup>5</sup> / <sub>8</sub> "
M1-14430PST	Painted Steel Top Kit	144" x 30" x 1 <sup>5</sup> / <sub>8</sub> "

## 8 RISER FRAMES



**PAINTED RISER FRAME WITH STAINLESS STEEL TAPERED CHASE**



Sample configuration



**PAINTED RISER FRAME WITH STAINLESS STEEL CHASE**

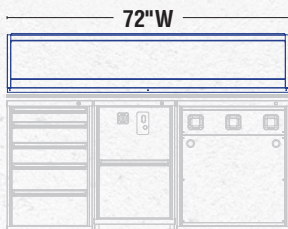

Sample configuration



**PAINTED RISER FRAME WITH PAINTED CHASE**

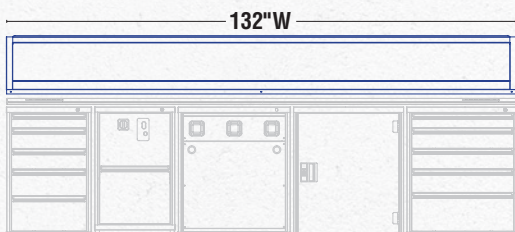

Sample configuration

Width x Depth x Height

A1-048RFTS	Riser Frame Tapered Stainless Kit	48" x 18" x 19"
A1-054RFTS	Riser Frame Tapered Stainless Kit	54" x 18" x 19"
A1-060RFTS	Riser Frame Tapered Stainless Kit	60" x 18" x 19"
A1-072RFTS	Riser Frame Tapered Stainless Kit	72" x 18" x 19"
A1-084RFTS	Riser Frame Tapered Stainless Kit	84" x 18" x 19"
A1-090RFTS	Riser Frame Tapered Stainless Kit	90" x 18" x 19"
A1-096RFTS	Riser Frame Tapered Stainless Kit	96" x 18" x 19"
A1-102RFTS	Riser Frame Tapered Stainless Kit	102" x 18" x 19"
A1-108RFTS	Riser Frame Tapered Stainless Kit	108" x 18" x 19"
A1-114RFTS	Riser Frame Tapered Stainless Kit	114" x 18" x 19"
A1-120RFTS	Riser Frame Tapered Stainless Kit	120" x 18" x 19"
A1-126RFTS	Riser Frame Tapered Stainless Kit	126" x 18" x 19"
A1-132RFTS	Riser Frame Tapered Stainless Kit	132" x 18" x 19"
A1-144RFTS	Riser Frame Tapered Stainless Kit	144" x 18" x 19"

\* This option is only applicable to the Tapered Work Surface.

A1-048RFS	Riser Frame Stainless Kit	48" x 18" x 19"
A1-054RFS	Riser Frame Stainless Kit	54" x 18" x 19"
A1-060RFS	Riser Frame Stainless Kit	60" x 18" x 19"
A1-072RFS	Riser Frame Stainless Kit	72" x 18" x 19"
A1-084RFS	Riser Frame Stainless Kit	84" x 18" x 19"
A1-090RFS	Riser Frame Stainless Kit	90" x 18" x 19"
A1-096RFS	Riser Frame Stainless Kit	96" x 18" x 19"
A1-102RFS	Riser Frame Stainless Kit	102" x 18" x 19"
A1-108RFS	Riser Frame Stainless Kit	108" x 18" x 19"
A1-114RFS	Riser Frame Stainless Kit	114" x 18" x 19"
A1-120RFS	Riser Frame Stainless Kit	120" x 18" x 19"
A1-126RFS	Riser Frame Stainless Kit	126" x 18" x 19"
A1-132RFS	Riser Frame Stainless Kit	132" x 18" x 19"
A1-144RFS	Riser Frame Stainless Kit	144" x 18" x 19"

A1-048RFP	Riser Frame Painted Kit	48" x 18" x 19"
A1-054RFP	Riser Frame Painted Kit	54" x 18" x 19"
A1-060RFP	Riser Frame Painted Kit	60" x 18" x 19"
A1-072RFP	Riser Frame Painted Kit	72" x 18" x 19"
A1-084RFP	Riser Frame Painted Kit	84" x 18" x 19"
A1-090RFP	Riser Frame Painted Kit	90" x 18" x 19"
A1-096RFP	Riser Frame Painted Kit	96" x 18" x 19"
A1-102RFP	Riser Frame Painted Kit	102" x 18" x 19"
A1-108RFP	Riser Frame Painted Kit	108" x 18" x 19"
A1-114RFP	Riser Frame Painted Kit	114" x 18" x 19"
A1-120RFP	Riser Frame Painted Kit	120" x 18" x 19"
A1-126RFP	Riser Frame Painted Kit	126" x 18" x 19"
A1-132RFP	Riser Frame Painted Kit	132" x 18" x 19"
A1-144RFP	Riser Frame Painted Kit	144" x 18" x 19"



## 9 UPPER CABINETS

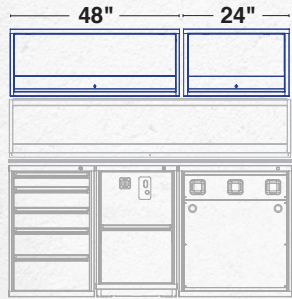

Sample configuration

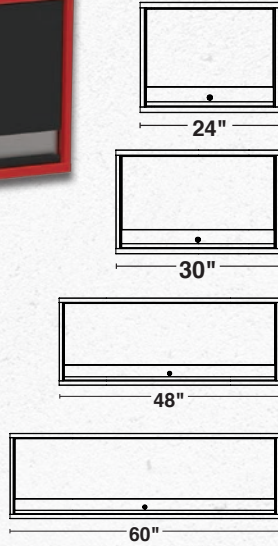

Width x Depth x Height

**A1-241819UPC** Upper Cabinet 24" x 18" x 19"

**A1-301819UPC** Upper Cabinet 30" x 18" x 19"

**A1-481819UPC** Upper Cabinet 48" x 18" x 19"

**A1-601819UPC** Upper Cabinet 60" x 18" x 19"

*\*Upper Cabinets can also be mounted to wall, rather than using riser frame.*

### COMPUTER SUPPORT ARM



#### A1-CSA

- Designed to support a laptop or a computer keyboard and mouse.
- Can be located under upper cabinet or under riser.

### PIVOTING MEDALLION LIGHT



**A1-UTLS** Starter Unit  
**A1-UTLA** Adder Unit

- Streamlined LED Lighting.
- Ability to pivot for angled lighting.
- Mounts magnetically (no screws).
- 24" in length.

## SERVICE CARTS



The **Service Cart** is a mobile platform for technicians' tools and repair parts. Designed to fit under the work surface and behind a lockable garage, this cart can maneuver right where you need it.

Width x Depth x Height

**A1-BSC** Basic Service Cart 22" x 24" x 34"

**A1-BSCF** Basic Service Cart with 12" Flipup 22" x 24" x 34"

**A1-BSCFH** Basic Service Cart with Flipup and Hardwood 22" x 24" x 34"

*Pictured below, in order from left to right*



- 4 - Swivel casters on non-marking impact resistant treads.
- 2 - 100 lb. capacity fixed (top & bottom) shelves.
- 1 - 100 lb. capacity adjustable (middle) shelf.



## SIDE-BY-SIDE MOBILE CABINETS



- Stainless steel tops and push/pull handle standard.
- (2) locking swivel & (2) straight 6" casters.
- Progressive operation provides for the smoothest operating drawers in the industry.
- 400 lb. capacity w/ 110% full extension for full access to back of drawer.
- Auto-safety clips lock the suspension to the drawer, preventing accidental release.
- All drawers are supplied with a black, polyester mesh liner.
- Single drawer access standard.
- Locks are keyed-alike.

41" height cabinets

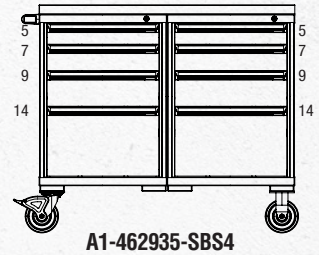
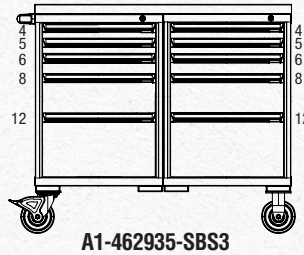
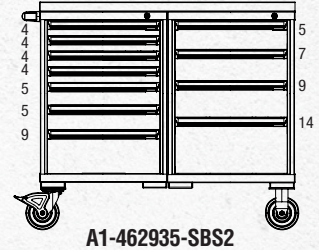
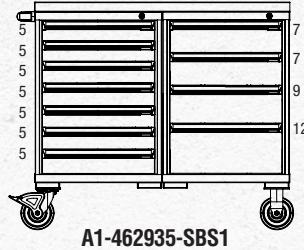

45" height cabinets

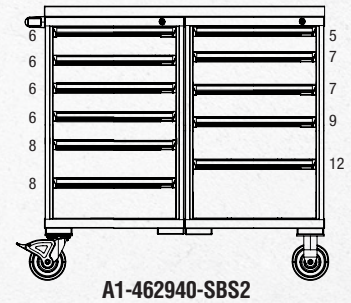
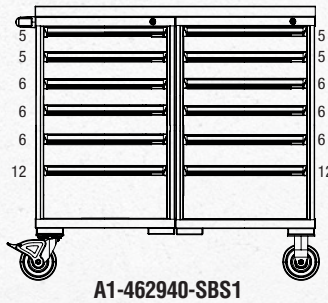

Drawer Table	Drawer Number	4	5	6	7	8	9	10	11	12	13	14	15	16	17	18	
	Usable Height	2 <sup>1</sup> / <sub>4</sub> "	3 <sup>1</sup> / <sub>16</sub> "	3 <sup>7</sup> / <sub>8</sub> "	4 <sup>5</sup> / <sub>8</sub> "	5 <sup>7</sup> / <sub>16</sub> "	6 <sup>1</sup> / <sub>4</sub> "	7"	7 <sup>3</sup> / <sub>4</sub> "	8 <sup>9</sup> / <sub>16</sub> "	9 <sup>3</sup> / <sub>8</sub> "	10 <sup>1</sup> / <sub>8</sub> "	10 <sup>15</sup> / <sub>16</sub> "	11 <sup>3</sup> / <sub>4</sub> "	12 <sup>1</sup> / <sub>2</sub> "	13 <sup>5</sup> / <sub>16</sub> "	
	Drawer Size	Small			Medium				Large								



Same features as above, and in addition:

- Shelves feature a 400 lb. capacity.
- Includes (1) bottom shelf and (1) adjustable shelf.
- Unique die-cast pull handle with a 3-point locking system.

41" height cabinets

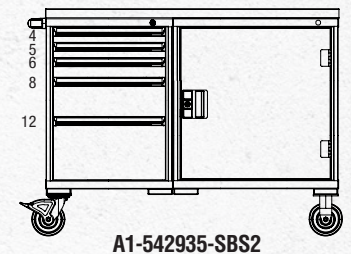
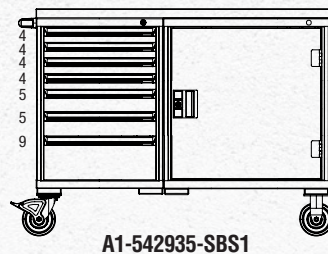

45" height cabinets

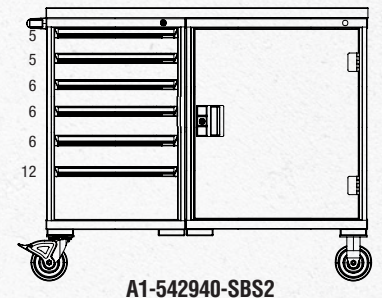
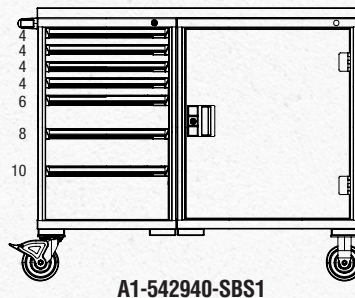



# AROUND THE SHOP

BORROUGHS CARRIES A WIDE range of heavy-duty equipment for your service department and maintenance areas. With over 200 sizes and styles of shop & tech benches available, Borroughs is sure to have a product for your needs.



*Pictured is our popular 130 Series Tech Bench, shown with optional stainless steel top, back and side guards.*

## 100 Series Tech Benches

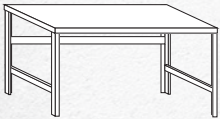

- WB100-XXX** 48" x 28"
- WB102-XXX** 60" x 28"
- WB104-XXX** 72" x 28"

## 170 Series Tech Benches

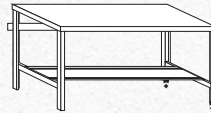

- WB170-XXX** 48" x 28"
- WB172-XXX** 60" x 28"
- WB174-XXX** 72" x 28"

## 120 Series Tech Benches

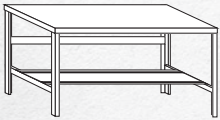

- WB120-XXX** 48" x 28"
- WB122-XXX** 60" x 28"
- WB124-XXX** 72" x 28"

## 180 Series Tech Benches

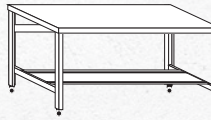

- WB180-XXX** 48" x 28"
- WB182-XXX** 60" x 28"
- WB184-XXX** 72" x 28"

## 130 Series Tech Benches

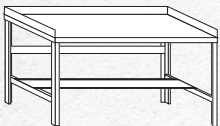

- WB130-XXX** 48" x 28"
- WB132-XXX** 60" x 28"
- WB134-XXX** 72" x 28"

## 300 Series Wall Mounted Tech Bench

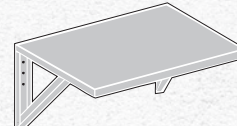

- WMB300-XXX** 48" x 28"
- WMB302-XXX** 60" x 28"
- WMB304-XXX** 72" x 28"

## 160 Series Tech Benches

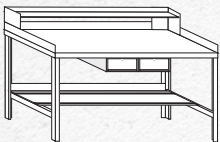

- WB160-XXX** 48" x 28"
- WB162-XXX** 60" x 28"
- WB164-XXX** 72" x 28"

*For Tech Bench with Stainless Steel Top, add "SS" suffix to part number before "-XXX".*

*All open leg tech benches feature leg height adjustment from 28" to 36" on 1" centers.*

## TRANSMISSION TEAR-DOWN BENCH



- Ideal for transmission and engine repair.
- Removable plastic bin is standard.
- Two rigid and two locking casters.
- 48" x 28" top angles to a drain.
- Adjustable leg height.
- Shown with optional tier drawer.

Part Number	Description
<b>11106-001-XXX</b>	Transmission Tear-Down Bench with Stainless Steel Top
<b>11106-000-XXX</b>	Transmission Tear-Down Bench with Painted Steel Top
<b>14865-000-XXX</b>	Tier Drawer 15.25" x 20" x 7.25" (can be used with any open leg tech bench)

## GET MORE FROM BORROUGHS

BORROUGHS' PROPRIETARY DESIGN SOFTWARE, CONFIGURA<sup>®</sup>, makes planning and approving designs simple. Configura ties together many factors that are key to a successful project. AutoCAD drawings can be imported into or exported out of Configura. Customers can see how everything comes together before production, viewing updated costs in real-time as designs are created and modified. Incorporating this tool allows Borroughs to design and layout a COMPLETE dealership or repair shop and provide a 3D rendering. This takes the guess work out of a project, giving our customers a more accurate and detailed description prior to their purchase.

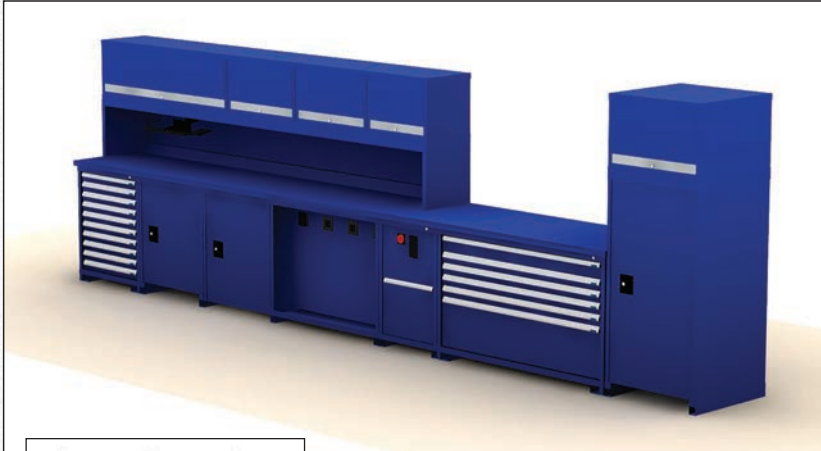

**Above:** Configura software allows you to place and change various components to layout the workstation exactly how you need it.

**Right:** After the layout is complete, Configura will produce photo-realistic renderings allowing Borroughs and its dealers to easily change perspective and colors, accurately reflecting your purchase.

**Below:** With Configura, Borroughs is able to layout a **complete** dealership from parts, service and even file storage.

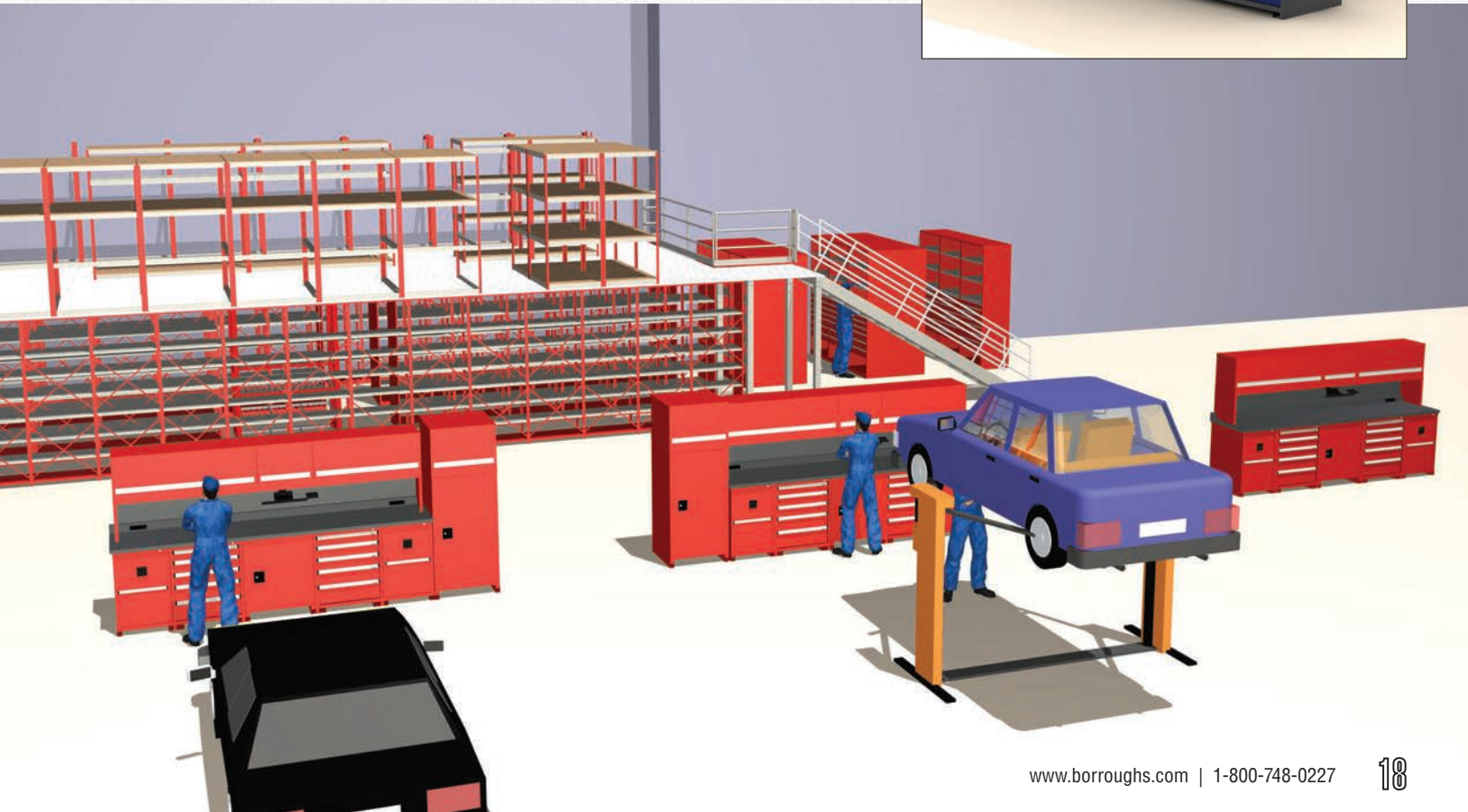

# BORROUGHS STANDARD POWDER COAT COLORS

Borroughs powder coat finishes are high quality, durable and inert. Borroughs offers 7 standard colors, or 49 different color combinations. We also offer custom color matching, using Borroughs computerized technology. The colors depicted on this publication have been reproduced using a printing process and are only provided as a guide. The actual painted product may vary. All colors are not available on all products.

Please contact your Borroughs Dealer for details.

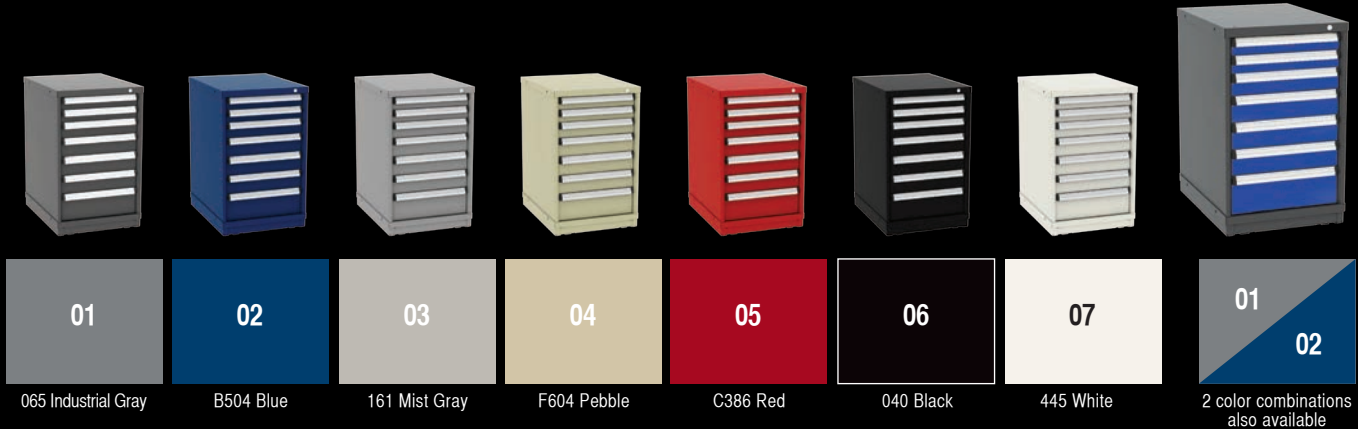



# Material Handling USA

**Call Now for a Free Quote or Site Visit!**

222 S. Main St. 5th Floor  
Salt Lake City, UT 84101  
800-326-4403  
<https://www.mh-usa.com/>

SUPERSTORE

MH-USA

Material Handling USA



Borroughs Corporation